

Glueless Laminate Installation Instructions— Wood Designs

CAUTION: WOOD DUST

The International Agency for Research on Cancer has classified wood dust as a nasal carcinogen. The sawing, sanding, and/or machining of wood products can produce wood dust that can cause respiratory, eye, and skin irritations.

Wood machining power tools should be equipped with a dust collector to reduce airborne wood dust. Wear an appropriate NIOSH designated dust mask to reduce exposure to airborne wood dust. Avoid contact with eyes and skin by using proper safety glasses and protective clothing. In case of irritation, flush eyes or skin with water for at least 15 minutes. For further technical for installation questions or to request a Product Specification Data Sheet contact the manufacturer at 1-800-441-7429.

Attention California Installers and Consumers

WARNING

Installation of this product and any wood product may create wood dust, which is known to the State of California to cause cancer.

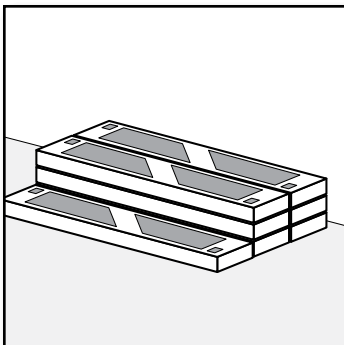

[1] Do not store cartons near heating / cooling ducts or direct sunlight.

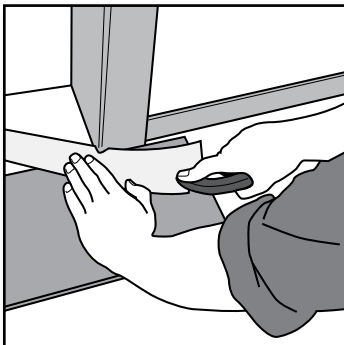

[2] Undercut doorjamb for a professional fit. Doorways less than 6' wide require T-Molding.

Typical Tools Required

Broom, Electric Saw (carbide blade), Eye and Ear Protection, Glue, Hammer, Painter's Tape, Pencil, Pull Bar, Straight-edge (6 ft), Tape Measure, Utility Knife, Wall Spacers (1/4"), Wood Chisel.

Preparation

Glueless Laminate can be installed directly over most existing floor coverings except for carpet. Wood flooring glued to concrete must be removed before installation.

Acclimation

- No acclimation period is required when installation site conditions are climate controlled prior to and during installation of Shaw Laminate Flooring Products. This means that Shaw Laminate Flooring products can be installed faster and more efficiently than conventional alternatives.
- During the installation period, temperature should be maintained between 65° F to 85° F and relative humidity should be between 35% to 65%.
- **[1]** Do not store cartons near heating/cooling ducts or direct sunlight.

Subfloor Preparation

- Fill any low spots in the subfloor greater than 1/8" in 6 feet with a Portland cement leveling compound. Check this by using a 6' straight edge. Remove any high spots by sanding or grinding.
- Remove any existing floor molding (if any) except for the wall baseboards. (Unless you plan to replace with Shaw color coordinated Wallbase).
- **[2]** To undercut door frames, lay a loose plank upside down against the frame and on top of the underlayment. This will be your guide for proper height to allow installed planks to float under the door frame. Saw the bottom of the doorjamb case molding back to the wall studs so that 1/4" expansion gap is maintained when laminate is fitted under doorjamb case molding.
- Sweep the subfloor clean.

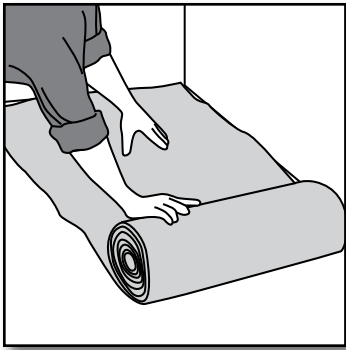

[3] Roll out just enough underlayment for the next few rows of planks you're installing.

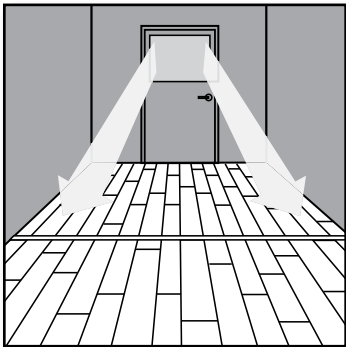

[4] Try to run planks parallel to main light source. T-molding is only required for rooms of more than 1,040 sq. ft.

Subfloor Moisture Testing

- **On Concrete Subfloors**— Always test a concrete subfloor for excessive moisture before installing over concrete, concrete covered with ceramic tile, marble, stone, vinyl tile, or linoleum. To test concrete, use a properly calibrated and reliable concrete moisture meter. The maximum allowable moisture content percentage for concrete is 4%. If the moisture meter readings are above 4%, have a qualified floor covering contractor perform a Calcium Chloride moisture Emissions test. The maximum allowable reading for a Calcium Chloride Test is 5 lbs./1000 sq. ft./24 hours.
- **On Wood-based Subfloors**— Moisture content of the wood subfloor must not exceed 12% when checked using a pin-type wood moisture meter. Whenever readings are higher than 12%, **full evaluations** of the joist systems, crawl spaces or basement areas beneath the wood subflooring are also necessary.

Installing Underlayments

When installing products with preattached acoustical underlayment:

- **On Concrete Subfloor**—use minimum 6-mil polyethylene (plastic) sheeting as a vapor barrier. Roll out the plastic, overlapping the seam area 6 to 8 inches, and tape the seams with a clear plastic sealing tape.
- **On a Wood Subfloor**—no additional plastic vapor barrier should be installed.

When installing products without preattached acoustical underlayment:

Please read the installation guidelines included with your chosen underlayment, and strictly follow those instructions when installing your underlayment.

- **[3]** Unroll one width of underlayment along the longest wall. Always work from left to right. Planks should run lengthwise against the longest wall, and if possible, **[4]** parallel to incoming sunlight.
- **[4]** Rooms larger than 26 x 40 feet (1,040 sq. ft.) require T-molding for expansion. Floor spans should not exceed 40' in any direction.

Start of Installation

- The width of the first row of planks should be approximately the same width as the last row. This may require cutting the first row plank to a shorter width. Measure across the room (inches) and divide by the width of a plank to see how many full width planks will be used and what size width will be needed for the last row. The last row should never be less than 2" in width.
- Use 1/4" spacers to maintain the proper expansion gap around the entire perimeter of the floor. **Quarter Round** molding will cover this expansion gap. **IMPORTANT:** this 1/4" gap must be maintained around cabinets, pipes, toilet flanges and any other obstacles in floor.
- **INSPECT EACH BOARD CAREFULLY FOR DAMAGE PRIOR TO INSTALLING IT.**
- Do not install a damaged plank. If you have any concern about the product fit or finish, **call Muchsee Customer Service at 706-695-4682 for information.**
- Check groove on plank to make sure it is clean and free of debris.

Follow installation steps [1]–[17]

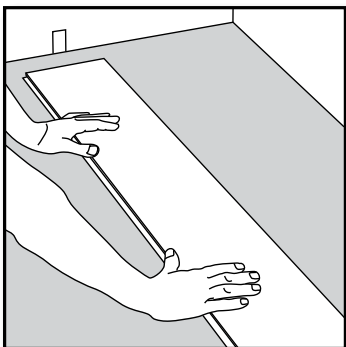

[1] Assemble three or four rows well away from the starting wall. Begin by placing the tongue of the short plank toward the starting wall.

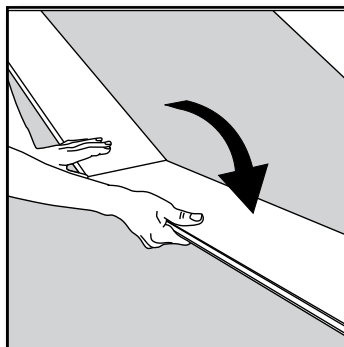

[2] To start the first row, press the end seam of the second plank at an angle to the end seam of the first plank, and then lock them together by laying the plank down. Complete the entire first row in this manner.

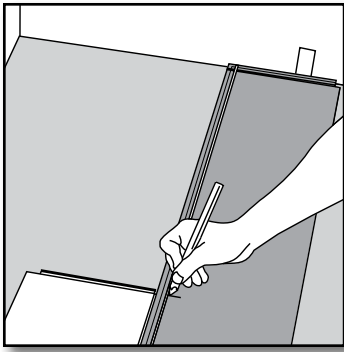

[3] To measure a shorter plank section for the end of the first row, place the final plank face down with the short tongue of the end seam toward the wall. Remember to allow for a minimum 1/4" expansion space. Draw a pencil line where this plank is to be cut.

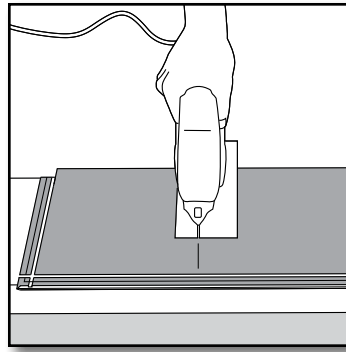

[4] Place the plank face down on the work surface and cut to size with a power saw. If you are using a hand saw, use a fine-toothed blade and cut the planks face up.

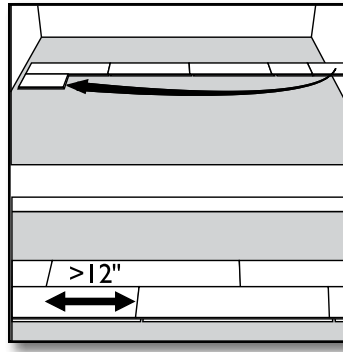

[5] Use a cut piece of board from the previous row to start the next row. This starting plank section must be at least 12" long. If the piece is too short, start with a new board. Cut the new board in one-third, one-half or two thirds length sections, depending upon what is required to maintain the random stagger from one row to the next. Always ensure that the end joints are staggered at least 12 to 16 inches from one row to the next.

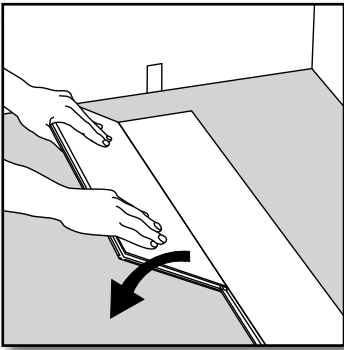

[6] Place the short start board for the second row firmly against the side seam of the start board in the first row, but do not fold it down to lock it into place yet.

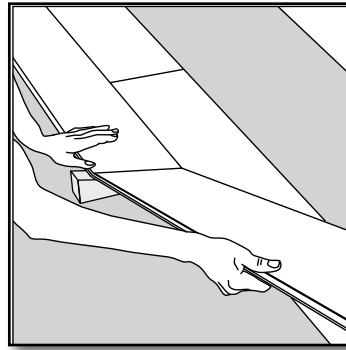

[7] Attach the second plank of the second row to the first planks end seam; but again, do not fold these planks down into the locked position. You can easily construct wood wedges to help hold these planks in place in the unlocked position (see diagram).

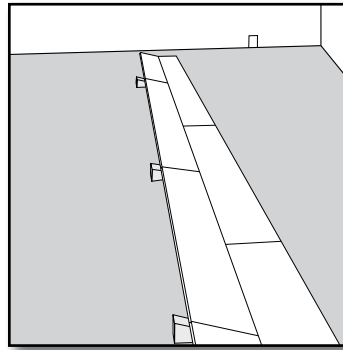

[8] After you have connected three or four planks of the second row in this manner, you can now go back and lock the side seams of the first planks into position.

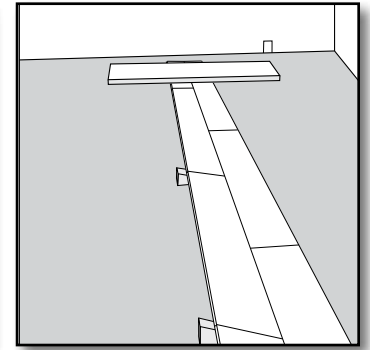

[9] Use a carton of planks as a weight to hold down the locked planks (see diagram). Remove the wood wedges and lock each plank as you move down the remainder of each row. If needed, you may use a short length of a two-by-four as a tapping block to help with your alignment when constructing the starting rows. Remember to do this by holding the block firmly in your hand while tapping gently against the leading edge of the plank. NEVER use a hammer for this task because you may damage the plank edge and the locking ridge!

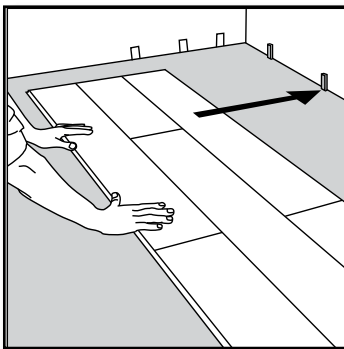

[10] Once you have assembled three or four start rows, you can slide these rows into position against the start wall of the room. Remember to allow for proper expansion spaces, and use the spacers to maintain those expansion areas along all walls and around any fixed objects within the flooring area. As you finish the rows in rooms with long spans, continue to stay three or four planks ahead of the locked side seam position planks. Use the wood wedges to help maintain the raised, unlocked plank positions.

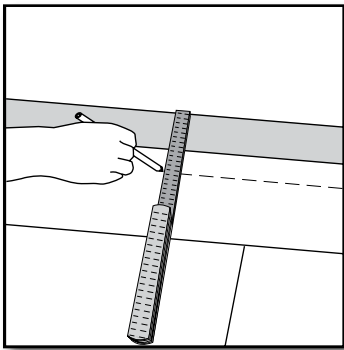

[11] If the starting wall is uneven, the planks must be adapted to its contours. You can scribe the contour of the wall onto the first row of planks by using a ruler and a pencil to follow along the contour of the wall. Do not forget to allow for the minimum 1/4" expansion space from the wall. Disassemble the first row, cut the planks along the line you have drawn, and then reassemble. You must still use the spacers to maintain the expansion space along this wall.

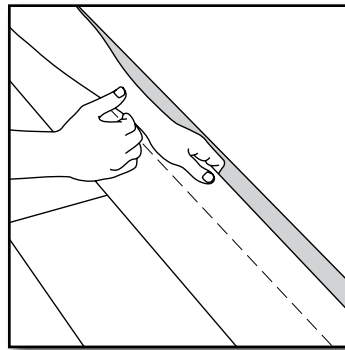

[12] To remove the first row for cutting, lift the planks a few inches and tap along the joint. Cut the planks as required. Re-connect all of the first row end seams and replace the first row by pressing the first row into place with the groove toward the edge of the planks that are already in position.

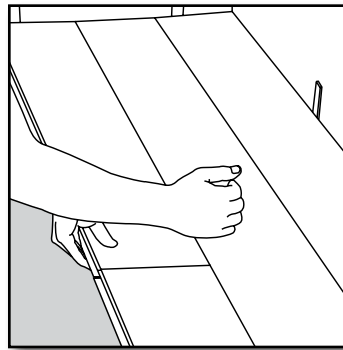

[13] You may have to disassemble the flooring due to obstructions, etc. Just lift the row of planks a few inches and tap along the joint.

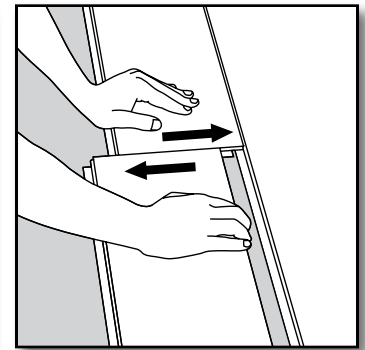

[14] The released planks can then be pulled apart by sliding them out horizontally. Never bend connected planks downwards; this will damage the planks' locking ridges.

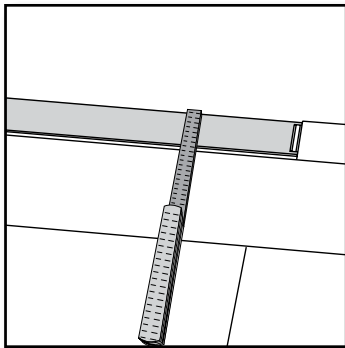

[15] Measure and cut the planks in the last row to fit. Remember to allow for a minimum of 1/4" expansion space from the wall.

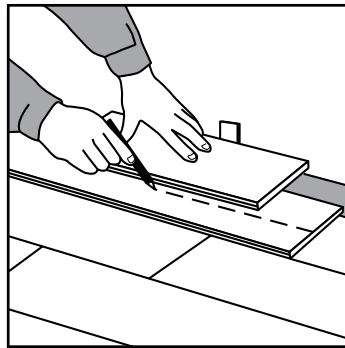

[16] Use a full width scrap plank to mark your cutting line on the last row.

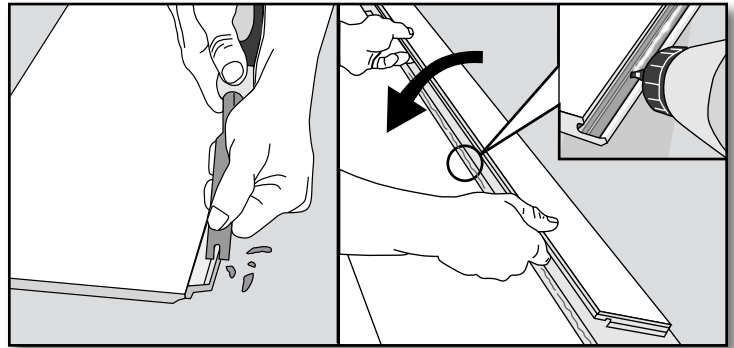

[17] In areas such as a doorjamb or cabinet kick base where planks cannot be angled to lock into place, use a wood chisel to remove the locking ridge from the bottom of the plank groove. Apply a 1/8" bead of tongue and groove adhesive to the bottom groove, and gently tap the plank into place using a pull bar and hammer. Next, apply enough strips of painter's tape across this seam to hold the joint securely in place until the adhesive sets. Using a clean, soft cloth, carefully clean up any excess adhesive on the surface of the planks.

Remainder of Floor

- Now you can continue to add additional rows using the same method of assembly. Work on top of your start rows and pull the planks toward you to position them before locking them into place.
- **Randomly pull planks from 3 cartons at a time** to ensure random appearance. Use cut pieces from the end of each row as starting planks. Always stagger end joints a minimum of 12"; make random so as not to show a repeating pattern.
- **All joints should be a tight fit with no gaps.** Stop and reconnect if a joint is not tight or if all edges are not even with adjacent planks. These planks can be engaged and disengaged several times if needed to help make a correct installation.
- When cutting the last row, place a full row of planks directly on top of the previous row of installed planks (keeping the tongue in the same direction as that of the installed planks). Use the full width of a scrap piece of plank as a guide. Place a pencil next to the edge and trace a line down the planks following the contour of the wall. Cut planks on the pencil line and then connect the last row.

MOLDINGS AND TRANSITION INSTALLATION

Molding and Transitions Installation

- A complete line of trims and transition pieces are offered to finish your floor, including **T-Molding**, **Reducers**, **End Molding/Carpet Transitions**, **Wallbase**, **Quarter Round** and **Stairnosing**.
- The transition pieces, (excluding **Quarter Round** and **Wallbase**) can be easily secured in place with the **Molding Track** which can be screwed, nailed or glued with silicon adhesive directly to the subfloor. The use of **Molding Track** provides a fast, secure transition installation and minimizes the use of screws or nails through the decorative surface of the transition piece.
- **T-Molding** is used when two level flooring surfaces meet, like in a doorway or a narrow archway. In a doorway, center the **T-Molding** under the space that the closed door occupies. Likewise, in an archway, the **T-Molding** should be centered. To install the **T-Molding**, first install the molding track by gluing, screwing or nailing it 1/4" from the edge of each adjoining flooring surface (equals about 1 1/8"). Push the **T-Molding** into the track, working from left to right.
- When laminate flooring meets a flooring surface that is lower, use a **Reducer Strip**. Leave 1/2" space between the finished floor and the front edge of the reducer. Install the **Molding Track** by gluing, screwing or nailing it 1/4" from the edge of the flooring. Push the reducer into the track working from left to right.
- The **End Molding/Carpet Transition** works great when finishing the floor in areas that meet vertical objects and is also ideal for transitioning between your laminate flooring and carpet. To finish the flooring in areas that meet vertical objects like exterior doors, sliding glass doors, tubs or shower basins, raised hearths or low sills, leave a 1" space between the floor and the vertical object. Install the **Molding Track** by gluing, screwing or nailing it 1/4" from the flooring. Push the molding into the track working from left to right.
- When transitioning from laminate flooring to carpet, leave a 1" space between the finished floor and the front edge of the carpet. Install the **Molding Track** by gluing or nailing it 1/4" from the edge of the flooring. Push the molding into the track working from left to right. Finish the carpet by tucking it between the molding and the tack strip.
- **Note:** In heavy traffic areas, use screw-type fasteners or nails to permanently secure the molding into the **Molding Track**.
- The **Stairnosing** is used to finish stair treads and risers, which have been fully adhered to the floor using a Muchsee approved multipurpose flooring adhesive. Stop the flooring about 1 1/2" from the step's edge. Install the **Molding Track** by gluing, screwing or nailing it 3/4" from the edge of the stair tread. Apply construction grade adhesive to the **Stairnosing** where the molding makes contact with the stair tread. Push the **Stairnose** into the track from left to right. You must use either screw-type fasteners or nails through the face of the **Stairnose** to permanently secure it to the track. Place screws/nails into the **Stairnose** 2" from the end and 6" to 8" apart. (**Note: riser piece should be in place under Stairnosing before screws or nails are used**).
- To finish the perimeter of the room where the expansion space was left for the seasonal expansion and contraction of the flooring, remove spacers and install **Wallbase** and/or **Quarter Round**. Both of these moldings are installed by nailing them directly into the wall. Never allow nails or screws in the **Wallbase** or **Quarter Round** to enter into the laminate flooring or the expansion zone around the flooring perimeter, as it will prevent proper expansion and contraction of the flooring. You must pre-drill nail holes in both types of wall moldings before nailing, to eliminate any splitting. Be sure to nail the **Quarter Round** into the wall or **Wallbase** and not into the flooring as it will prevent expansion and contraction of the flooring.
- Silicone sealant should be used in expansion zones in bathrooms, near kitchen sinks, dishwashers and refrigerators with icemakers.

For any questions, call the Muchsee Customer Service at 706-695-4682.

CARE GUIDE

Glueless flooring is designed to stand up to the toughest household conditions. However, to keep it looking its best, follow these simple instructions for protection and care.

Routine Maintenance

- Use a damp cloth to blot up spills as soon as they happen. Never allow liquids to stand on your floor.
- Use acetone/nail polish remover on a clean white cloth to clean tough spots such as oil, paint, markers, lipstick, ink, or tar. Wipe the area with a damp cloth to remove any remaining residue.
- Regularly sweep, dust, or vacuum the floor with the hard floor attachment (not the beater bar) to prevent accumulation of dirt and grit that can scratch or dull the floor finish.
- Periodically clean the floor with cleaning products made specifically for laminate floor care.
- Do not wash or wet mop the floor with soap, water, oil-soap detergent, or any other liquid cleaning material. This could cause swelling, warping, delamination, and joint-line separation, and void the warranty.
- Do not use steel wool, abrasive cleaners, or strong ammoniated or chlorinated type cleaners.
- Do not use any type of buffing or polishing machine.
- For spots such as candle wax or chewing gum, harden the spot with ice and then gently scrape with a plastic scraper such as a credit card. Be careful not to scratch the flooring surface. Wipe clean with a damp cloth.
- A more frequent dust-mopping or vacuuming schedule may be required in very sandy areas such as a beach home.

Environmental Protection:

- Entry mats will help collect the dirt, sand, grit, and other substances such as oil, asphalt, or driveway sealer that might otherwise be tracked onto your floor.
- To prevent slippage of area rugs, use an approved vinyl rug underlayment.
- Use floor protectors and wide, load-bearing leg bases/ rollers to minimize the chance of indentations and scratches from heavy objects. As a rule, the heavier the object, the wider the floor protector.
- To minimize the natural expansion and contraction of the wood, maintain a normal indoor relative humidity level between 35 and 65% throughout the year.

a. Heating season (Dry): A humidifier is recommended to prevent excess shrinkage due to low humidity levels. Wood stove and electric heat tend to create very dry conditions.

b. Non-Heating Season (Wet): An air conditioner, dehumidifier, or periodically turning on your heating will help to maintain humidity levels during summer months.

- Avoid excessive exposure to water during periods of inclement weather.
- Keep your pet's nails trimmed to prevent them from scratching your floor.
- Never try to slide heavy objects across the floor.
- A protective mat should be used under furniture or chairs with castors/wheels.

Minor Repair Instructions:

- In the event that accidental damage occurs, minor scratches or dents can be repaired using a Flooring Touchup or Color-fill Kit. This special touchup kit contains a filler material that is color coordinated to the color of your floor. When Color-filled properly, the repaired area is often invisible. The repaired area should hold up to foot traffic and wear just like the rest of your laminate flooring.

Glueless Laminate Board Replacement Repairs:

- Shaw glueless laminate may be assembled and disassembled several times.
- Carefully disassembled glueless joints will retain their original locking integrity during reassembly. New replacement plank(s) should be acclimated in the replacement area for at least 72 hours. This allows them to equalize to the conditions of the flooring in the room where the replacement(s) will take place.
- To replace the damaged board(s), first remove baseboard, wall base, or Quarter Round as needed. Take the flooring apart one row at a time. Lift each row to detach, then separate the individual boards.
- Be sure to stack the individual planks in the proper order for re-installation. This usually eliminates the need to cut planks for start or end of the row lengths.
- For best visual results, replace the damaged board with a piece from the edge of the original installation.
- Insert the properly acclimated new plank(s) along the outer edge of the original flooring installation during reassembly. This practice minimizes the chance that a newer plank will stand out from the original installation.
- Reinstall the baseboard, wall base, or quarter round, and the replacement repair is complete.