



OWNER'S WARRANTY MANUAL

NFM



Serial Number #: _____

Purchased From: _____ Date of Purchase: _____

American Adjustables

2618 Brick Church Pike

Nashville, TN 37207

1-855-690-6699

TABLE OF CONTENTS



Please do not return to store – do not contact store

Please call for assistance if base is missing parts or is not functional:

[1-855-690-6699](tel:1-855-690-6699)/customerservice@americanadjustables.com

Important Information and Safety Precautions – page

Part List-----page 5

Installation Guide-----page 6

Wireless Remote Control Setup-----page 7

Trouble Shooting Guide-----page 7

Headboard Bracket Available-----page 9

Additional Accessory Items-----page 10

Limited Warranty-----page 11

CFR 1633 Compliant with most mattresses

UL Approved Components

Assembled in the USA

American Adjustables 1-855-690-6699 TOLL FREE

IMPORTANT INFORMATION

Congratulations on your purchase of an “American Adjustables” Base

- Read this complete Owner’s Manual for information on how to operate your new Adjustable Base. Follow instructions on how to operate, install, and maintain this product.
- Check the carton that the Adjustable Base was delivered in and verify all items are unpacked before discarding.
- This product is not intended for young children or persons needing supervision.
- This product is designed to be used indoors and is never to be used outdoors.
- This Adjustable Base is designed for in-home use only. IT IS NOT designed for HOSPITAL USE and is NOT built to HOSPITAL STANDARDS.
- DO NOT use this Adjustable Base with any Oxygen Type Tent equipment.
- If you see any damage to cords, Lifting Motors, Hand Controls, or any other parts on the Adjustable Base, discontinue use immediately. Put in a flat position, if possible, unplug, and call customer service – 1-855-690-6699.
- It is the Operator’s responsibility to ensure that the Adjustable Base is able to move without risk to the operator or bystanders, and that children and pets are under supervision before operation.
- ALWAYS have your Serial Number and Date of Purchase handy when communicating with customer service. The Serial Number can be found on the front of this Owner’s Manual, Warranty Registration Card, on the FOOT Section frame on the base, as well as on the COVER LAWTAG located at the head of the base upholstery.

Electrical Safety Precautions

- Installation should be performed by 2 persons for safety reasons.
- For optimal safety, it is recommended that this Adjustable Base be plugged into a surge protector (not provided). This product will only plug into a grounded electrical outlet.
- The power cord for this product has a polarized plug (one blade is wider than the other). It will only fit into a polarized outlet one way. If it does not fit correctly into an outlet, reverse the plug. If it still does not fit securely, contact a qualified electrician to install a proper outlet. DO NOT make any changes to the plug in any way.
- Always unplug this Adjustable Base before any Maintenance is attempted.
- DO NOT open any control boxes, motors, or sealed hand controls (other than to replace batteries). The product warranty will be voided if these components are tampered with.
- DO NOT attempt to alter any wiring.
- Dispose of all packaging material after base is unpacked as these materials may be harmful to small children and pets
- Children should not play on or around this product.

SAFETY PRECAUTIONS

Pacemaker Warning:

This Adjustable Base may have an “Optional” massage feature. The massage feature (optional on some models) may produce a vibrating sensation. It is possible that individuals with heart assist pacemakers may experience a sensation similar to exercise or movement. If you have a pacemaker – CONSULT your physician for complete information and any concerns.

Locking Casters:

Locking Casters are available as an option for this Adjustable Base. These Casters will prevent “most” bed movement for your safety when they are in the “locked” position.

However, it is also recommended that caster cups or carpet sections be used under each caster for wood or tile floors when the caster is in the “locked” position. The caster will not roll but could “slide” on an uncarpeted surface.

Lift Motors, Massage/Vibrating motors:

It is normal to hear a slight humming sound when using the lift motor/motors on an Adjustable Base as it raises and lowers. This sound will only be heard as motors are used to adjust base.

This Adjustable Base may have massage motor or motors included (optional on some models). It is normal to hear a minimal humming sound during operation. As the massage motor is increased this noise will increase and this is normal. You may experience excessive noises on wood or tile flooring. It is recommended to use rubber cups (not supplied/optional) or carpet squares (not supplied) under each leg to minimize noise levels.

Weight Restrictions:

There is a 650-lb. weight limit per base - EVENLY DISTRIBUTED across the surface of the base.

FCC Compliance:

Components comply with part 15 of the FCC Rules for residential use. This device may accept any interference received, including interference that may cause undesired operation. This equipment generates, uses, and can radiate radio frequency energy. If not installed and used in accordance with the instructions, it may cause harmful interference to radio communication.

Product Ratings:

Lift Motors – the Adjustable Base lift motors are not designed and should not be used for continuous use. Do not sit or bounce on the Adjustable Base when either the back or leg section is in a raised upright position.

Massage Motor/Motors – Bases that have optional massage motor/motors are rated for a maximum of 2 hours overall use within a 6-hour time period.

*****ANY OVER USAGE of above ratings will shorten the life expectancy of the product and may void the warranty*****

*****Do not sit on the foot or head of the Adjustable Base and use it as a lift mechanism as it is not designed to do so. For best performance results, consumers should enter and exit Adjustable Base when it is in the flat position.*****

Part Kit for Base Installation

Before discarding any packing materials, check that the Adjustable Base parts are as follows:

(Note: Parts Kit may vary depending on model purchased)

<u>Transit 2.2</u>	<u>Transit 3.2</u>	<u>InMotion 200</u>	<u>InMotion 300</u>
<ul style="list-style-type: none"> • 4- 2” Screw in legs • 4- 4” Screw in legs • 1- Hand control • 1- Owners manual • 1- Set up guide • 1- AC/USB power port extension cord. • 1- Sync cord (TXL, SQ, CALKING) 	<ul style="list-style-type: none"> • 4- 2” Screw in legs • 4- 4” Screw in legs • 1- Hand control • 1- Owners manual • 1- Set up guide • 1- AC/USB power port extension cord. • 1- Sync cord (TXL, SQ, CALKING) • 1- Headboard bracket 	<ul style="list-style-type: none"> • 4- 2” Screw in legs • 4- 4” Screw in legs • 1- Hand control • 1- Owners manual • 1- Set up guide • 1- AC/USB power port extension cord. • 1- Sync cord (TXL, SQ, CALKING) • 1- Headboard bracket 	<ul style="list-style-type: none"> • 4- 2” Screw in legs • 4- 4” Screw in legs • 1- Handcontrol • 1- Owners manual • Set up guide • 1- AC/USB power port extension cord. • 1- Sync cord (TXL, SQ, CALKING) • 1- Headboard bracket • 1- Power down box • 1-Bluetooth Receiver

Transit 2.2 Wireless



Transit 3.2 Wireless



InMotion 200



InMotion 300



Owners Manual

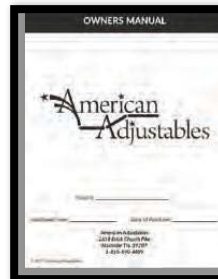

Warranty Registration



Installation Guide

****It is recommended that 2 Adults perform the installation process for safety reasons****

Step 1: Identify all parts needed for usage. Keep manual and all paperwork in a safe storage and record serial number and date of purchase.

Step 2:

Keep the underside of the Adjustable Base frame facing up and attach legs. Bases are delivered with an assortment of leg option heights to allow you to choose your best height adjustment. If needed, additional sizes are available on the Optional Accessory Item List.

Step 3:

Extend power cord from the packaging. Once all legs/casters are attached and tightened securely, slowly turn and LIFT base over so top of base is facing up.

DO NOT DROP BASE!

Step 4:

Remove any plastic wrapping and discard. KEEP OUT of reach of children and pets.

Step 5:

Plug base into a working, grounded electrical outlet. It is recommended that the base be plugged into an electrical surge protector (not included).

Step 6:

For Wired Hand Controls, uncoil cord and test base using all functions on handset that is attached. If base does not operate – consult trouble shooting guide in this manual.

For Wireless Hand Controls, install batteries where applicable. The base will need approximately 40 seconds before being able to receive a signal from the Hand Set once the base is plugged into the electrical outlet. See remote control handset instructions.

Step 7:

Return base to a flat position. Identify Capture Washer and Phillips head screw on foot section of base already installed. Use supplied hardware with Mattress Retainer bracket (1 per side). Loosen Phillips Head Screw “counter-clockwise” only a few turns (do not remove) high enough to allow Mattress Retainer to fit underneath the Capture Washer as shown. Once both sides are in position, tighten both sides to hold mattress retainer in place.



Retainer Bar

Step 9:

If Headboard is to be attached using Headboard Brackets (optional), locate Headboard Brackets and follow instructions included in carton.

***Should your base ever need service, please contact customer service 1-866-690-6699. A service technician will expertly make necessary repairs. Service technicians are not responsible for installing or removing headboards, footboards, or side rails to complete service. Service technicians are not responsible for moving furniture or items required to perform routine maintenance. Removing and replacing Sheets and Covers are not the responsibility of the technician. Testing functions, changing batteries, and checking for power to the Adjustable Base are considered non-warranty issues and are expected to be completed by the customer. ***

Adding or Programming a WIRELESS Remote Control

Your Wireless Remote Control included with your Adjustable Base will already be set (programmed) to your base. No Programming should be needed. The following instructions are included for your convenience should your remote need reprogramming or for adding an additional remote control another time. **PLEASE SEE ATTACHED INSTRUCTIONS FOR PROGRAMMING.**

CODING BUTTON 2.2/3.2



RESET BUTTON 200/300



TROUBLESHOOTING

Excessive Massage or Motor Noise

7

- If Adjustable Base is located on a hard surface floor, place rubber cups (optional accessory) or carpet squares under each leg or Caster (optional accessory).
- Check to be sure all hardware was removed upon delivery and set up. Check to be sure Headboard Brackets (optional accessory) are tight and installed properly. Make sure this is tightened firmly. Check existing frame for noise.
- Raise the Back and Leg sections slightly using the hand control when massage motors are on.
- Verify that the Adjustable Base is not touching the Wall or Headboard.

Troubleshooting for Hand Controls

Problem	Solution
Wireless Hand Control will not operate	<ul style="list-style-type: none">• Verify Adjustable Base is plugged into a working, grounded outlet. Test Outlet by plugging in another small appliance to check power. A grounded electrical surge protector is recommended but is not supplied with this Adjustable Base. Check light switch on wall.• Verify that the Adjustable Base power cord is plugged into the motor.• Verify that Hand Control illuminates. <u>Test batteries where applicable.</u>• Check the circuit breaker to be sure it has not been tripped.• Unplug power cord from electrical outlet or surge protector and wait 45 second and try again.
Adjustable Base	
Back and/or Leg will not Raise	<ul style="list-style-type: none">• Check to make sure that no obstruction is limiting the sections from lifting or lowering, if so remove obstruction.• Back section may be too close to Wall or Headboard which will stop movement.• Re-adjust position of base distance from wall or headboard.







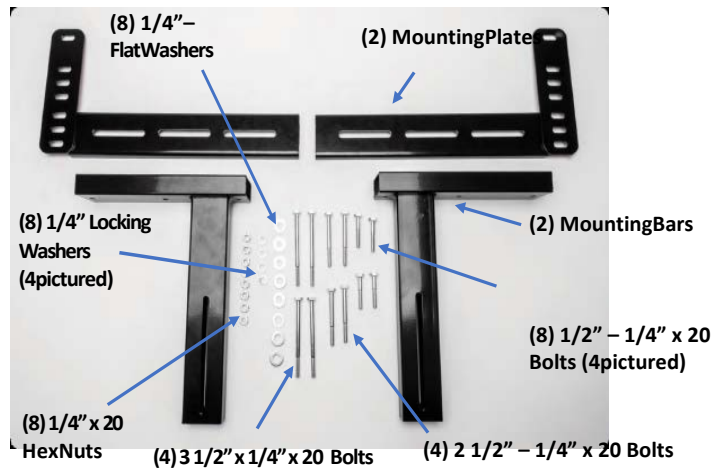









9

HEADBOARD BRACKET AVAILABLE

NOTE: This is an OPTIONAL ACCESSORY which can be purchased separately. Please refer to the Optional Accessory Page provided with your Owner's Manual.



OPTIONAL ACCESSORY ITEMS

<p>A</p> 	<p>B</p> 	<p>C</p> 
<p>D</p> 	<p>E</p> 	<p>F</p> 
<p>G</p> 	<p>H</p> 	<p>I</p> 
<p>J</p> 	<p>K</p> 	<p>L</p> 
<p>M</p> 	<p>N</p> 	<p>O</p> 
<p>P</p> 	<p>Q</p> 	<p>R</p> 

A. 2" Screw In Leg Set(4)

B. 4" Screw In Leg Set(4)

C. 6" Screw n Leg Set(4)

D. Caster Cups Large

E. 2" Glide (4)

F. 2" Screw In Locking Caster

G. PowerStrip with USB

H. Headboard Bracket Kit

I. Dual Base Attach. Kit

J. InMotion 200 Remote

K. Transit 2.2 Remote

L. Transit 2.2 Sync Cable

M. Transit 3.2 Remote

N. Transit 3.2 Sync Cable

O. Bluetooth InMotion 200 & 300

P. InMotion 300 remote

Q. Transit 4.0 Sync Cable

R. InMotion 200 & 300 Powerdown Box

Limited Warranty

In the explanation of this warranty: “Adjustable Base” means the Adjustable Base foundation ONLY, sold by American Adjustables or “American Adjustables”. The “Adjustable Base” does not include the mattress. The “Purchaser” and “You” both mean the Consumer/Customer who is the original purchaser of this Adjustable Base. This warranty is not transferable. The “Warranty Starting Date” means either the date “You” purchased a NEW and UNUSED “American Adjustables” Adjustable Base or the date of manufacture of this Adjustable Base verified by the Law Tag/Serial Number or a Valid Store retail receipt. If “You” purchased an Adjustable Base that has been used as a floor or display model, refer to the explanation below. All warranty claims require notice from “You” to be given to “American Adjustables” The time/date period of your initial contact call may be recorded, and will act as an initial opportunity to satisfy warranty below.

Period of Warranty as Purchased New & Unused:

1/3/10 years – Transit 2.0, 3.2 LIMITED WARRANTY

3/5/20 years- InMotion 200, 300- LIMITED WARRANTY

From **Warranty Starting Date** as set out in above description:

- Year 1 – American Adjustables will repair or replace any defective adjustable base part, and will pay all authorized labor and transportation costs associated with the repair or replacement of any parts to be defective in that 1st calendar year.
- Years 2-3 – American Adjustables will replace any part found to be defective at no charge. You/Customer/Consumer are responsible to pay all service/labor and transportation/shipping costs related to the costs of receiving and installation of the new part.
- Year 4-10 – Mechanism parts of the Adjustable Base will be covered under a pro-rated formula. Starting on the 4th Year and ending at the end of the 10th year, You/Customer/Consumer are responsible to pay all service/labor and transportation costs related to the costs of receiving and installation of the new part. The cost will be figured on the “current” cost of the replacement part, divided by 1/7th times (x) the number of year in the 4-10th year.

Example – if You/Customer/Consumer are replacing a part in the 8th year after purchase, your charge for the said part (@ \$100) would be - \$100 divided by the $1/7 = 14.29 \times 5$ (number of years used out of warranty $3-8=5$), your charge for said part pro-rated would be $\$14.29 \times 5 = \71.45 (plus shipping and labor).

For Floor/Display Model Adjustable Base:

- Base will NOT be warranted as above. **Warranty is voided on all floor/used models.**

- **EXCLUSIONS**

This warranty **does not** apply:

- To costs for unnecessary service calls, including costs for in-home service calls for the purpose of educating YOU about the adjustable base or finding a satisfactory power connection
- To any damage caused by YOU
- If there has been any repair or replacement of adjustable base parts by an unauthorized person
- If the adjustable base has been mishandled (whether in transit or by other means), subjected to physical or electrical abuse or misuse
- To damage to mattress or mattresses

- To water or any liquids
- To any bodily fluids – this will VOID all warranty
- To fabric
- To cables, electrical cords or any items not supplied by American Adjustables in original box (contact the dealer for warranty information on these items)
- If there has been any modification of the adjustable base
- If the recommended weight restriction is not followed (refer to the advisory section of the Owner's Manual)
- If you sell, give, or transfer the base to another person

The decision to repair or replace defective parts under this warranty shall be made, or cause to be made, by American Adjustables at its option and in its sole discretion.

A repair initiation should be the responsibility of the Purchaser. The limited warranty does not include reimbursement for the inconvenience, removal, installation, setup time, loss of use, shipping, or any other costs or expenses. American Adjustables service technicians will not be responsible for moving furniture or any other items not attached to the adjustable base in order to perform service on the adjustable base. It is the sole responsibility of YOU to provide adequate space and accessibility to the adjustable base. It is your responsibility to remove sheets/covers and all linens before service is performed. In the event that the technician is unable to perform service due to lack of accessibility, the service call will be billed to You and the service will have to be rescheduled.



customerservice@americanadjustables.com