







Assembly Instructions for



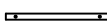

FULL BED

LT111FH/LT111FF/LT111TFR

Caution : Please read instruction thoroughly before unpacking assembly parts. Sharp, exposed staple tips can cause injury, therefore, for your protection, please remove any exposed staples used in packing.

1. We recommend that you should assemble this product with the assistance of another person; this will make assembly easier, and will help to eliminate damage to the product or injury to persons during assembly.
2. Be sure to check all packing materials carefully for small parts that may have come loose inside the carton during shipment.
3. Please do not over tighten screw or bolts.
4. Please put all parts on a non-abrasive floor before assembly, and follow the assembly steps to assemble your newly purchased product correctly and efficiently.

PART LIST				
NO	NAME	PART	CODE	QTY
A	Headboard			1pc
B	Footboard			1pc
C	Side Rail			2pcs
D	Full Bed Slats		PLT111FBSLT	11pcs
E	Full Center Vertical Slat		PLT111FBCSL	2pcs
F	Slat Support Leg		PLT111BDSPL	4pcs

HARDWARE LIST				
NO	NAME	PART	CODE	QTY
1	Allen key		FBHW	1pc
2	JCBC M6 x 60mm			4pcs
3	M6 Spring washer			4pcs
4	Screw 32mm			22pcs
5	Adjustable Leveller			4pcs
HARDWARE LOCATED IN FOOTBOARD BOX				

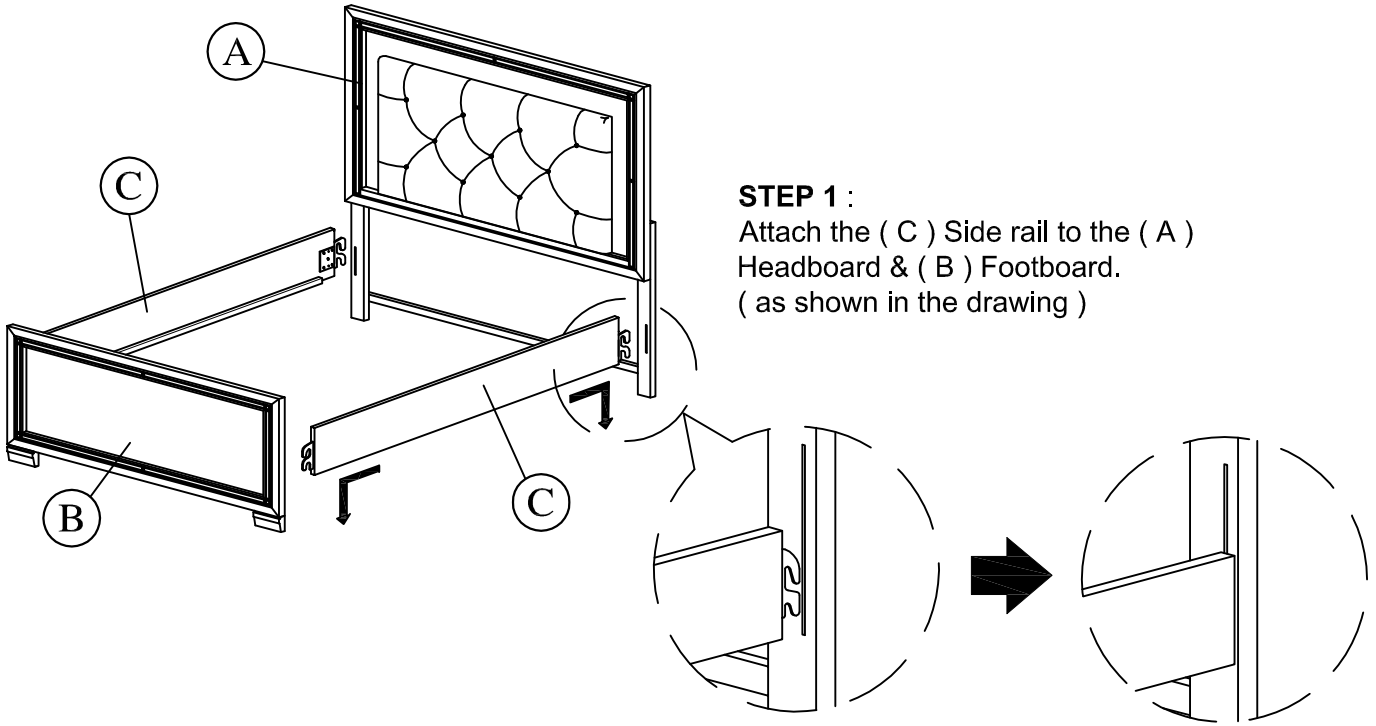

STEP 1 :
Attach the (C) Side rail to the (A)
Headboard & (B) Footboard.
(as shown in the drawing)

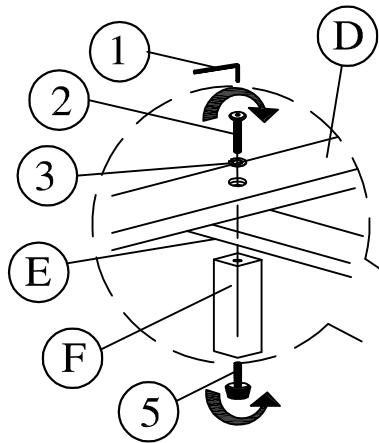

STEP 2 :
Attach (F) Support Leg to the bottom of
(E) Center Vertical Slat & (D) Bed Slat using
(2) JCBC 60mm & (3) M6 Spring Washer.
Attach the (5) Adjustable Leveler & adjust it to
level the bed with the floor.

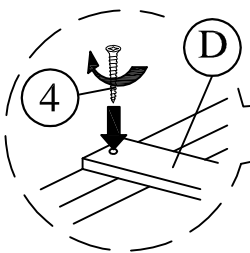

STEP 3 :
Secure the (D) Bed Slat
using the (4) screw 32mm
provided.

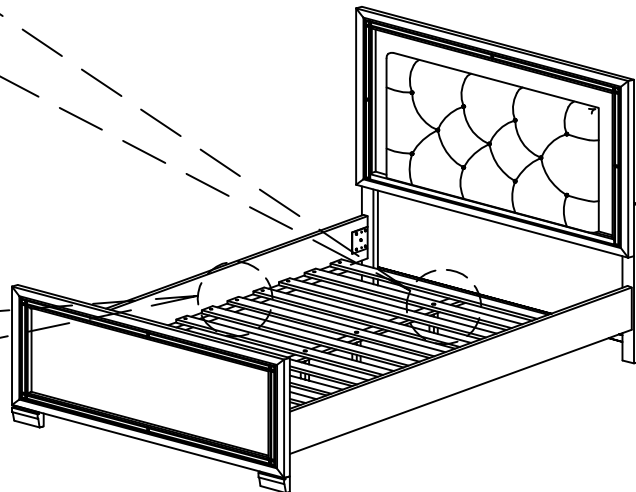

COMPLETED VIEW