

# SAMSUNG

## Product Guide

# 25 cu. ft. 33" 3-Door French Door Refrigerator with Beverage Center™

RF25C5551

Available in:

Fingerprint Resistant Stainless Steel



# Table of Contents

## Product Overview

Product Overview	4
Carousel Image Order	5

## Product Messaging

Features and Benefits	7
-----------------------	---

## Product Specs

Review Mapping and Related Product	11
Spec Sheet	12
<i>Will It Fit?</i> Guide	13
Energy Guide and User Manual	14
Warranty	15

## Feature Icons

17

# Product Overview

---

**RF25C5551 – 25 cu. ft. 33" 3-Door French Door Refrigerator  
with Beverage Center™**

# Product Overview

## Product Title

25 cu. ft. 33" 3-Door French Door Refrigerator with Beverage Center™

## Product Description (Paragraph)

The Samsung 33" French Door refrigerator creates a stylish and modern kitchen with its compact design and recessed handles. The Beverage Center™ provides convenient access to refreshing cold, filtered water. With the Dual Auto Ice Maker, you can select from cubed ice or Ice Bites™ that chill your drink faster.

## Product Description (Bullets)

- Create a stylish and modern kitchen with the Samsung 33" French Door refrigerator
- The Beverage Center™ provides convenient access to refreshing cold, filtered water
- The Dual Auto Ice Maker lets you choose from cubed ice or Ice Bites™ that chill your drink faster
- Available in Stainless Steel

## Easy Ads Link

**Stainless Steel:** <https://dam.gettyimages.com/p/z0c3461/digital-appliances?o=AND&q=RF25C5551SR>

## Available Color



**Fingerprint Resistant  
Stainless Steel**

RF25C5551SR



# RF25C5551SR Carousel Image Order

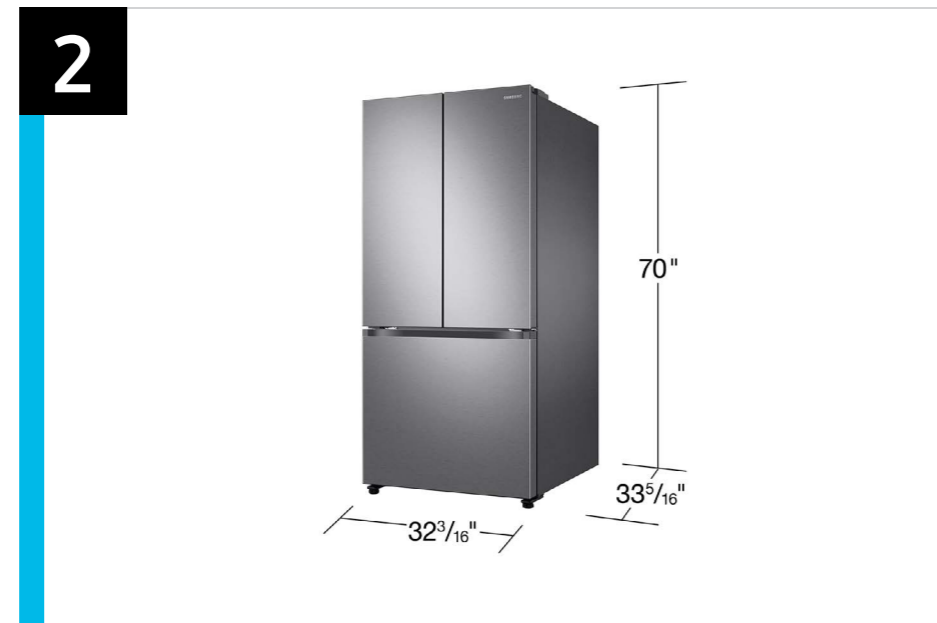



# Product Messaging



---

**RF25C5551 – 25 cu. ft. 33" 3-Door French Door Refrigerator  
with Beverage Center™**

## Features and Benefits – RF25C5551



Overall Product Headline	Feature Name	Long Body Copy	Short Body Copy	Associated Image
<b>Modern styling</b>	<b>Design</b>	The modern design features beautiful doors with recessed handles that blend seamlessly into your kitchen.	Modern, recessed handle design.	
<b>Water two ways</b>	<b>Beverage Center™ &amp; AutoFill Water Pitcher</b>	Convenient access to refreshingly cool, filtered water is always in reach. The Beverage Center™ includes a dispenser and AutoFill Water Pitcher so you can press or pour – with the option to infuse with a flavor.	Refreshing cold water is always within reach.	
<b>Ice your way</b>	<b>Dual Auto Ice Maker</b>	Choose from cubed ice or Ice Bites™ that chill your drink faster.* <small>*Compared to cubed ice.</small>	Get ice two ways, cubed or Ice Bites.™	

## Features and Benefits – RF25C5551

Overall Product Headline	Feature Name	Long Body Copy	Short Body Copy	Associated Image
<p><b>Compact design, large-capacity storage</b></p>	<p><b>Large Capacity</b></p>	<p>Store more with a spacious 25 cu. ft. interior.* Features SpaceMax™ technology that gives you extra storage space inside without compromising energy efficiency, so you can keep food fresher, longer.</p> <p><small>*Based on internal testing, compared to the RF20A model.</small></p>	<p>Compact and innovative design that maximizes interior storage space.</p>	
<p><b>Even cooling from corner to corner</b></p>	<p><b>All-around Cooling</b></p>	<p>Keep items at the same temperature throughout the interior so that everything stays fresher, longer. All-around Cooling uses evenly spaced vents and continuous temperature monitoring to ensure consistent cooling from corner to corner.</p>	<p>Cools evenly from corner to corner, so food stays fresher, longer.</p>	
<p><b>Energy management at your fingertips</b></p>	<p><b>SmartThings Energy</b></p>	<p>SmartThings Energy* lets you easily check power consumption and helps you adjust to stay within preset monthly targets.</p> <p><small>*Available on Android and iOS devices. A Wi-Fi connection and a Samsung account are required.</small></p>	<p>SmartThings Energy* monitors and optimizes your energy consumption to help reduce electricity bills.</p> <p><small>*Available on Android and iOS devices. A Wi-Fi connection and a Samsung account are required.</small></p>	



## Features and Benefits – RF25C5551 (Continued)

Overall Product Headline	Feature Name	Long Body Copy	Short Body Copy	Associated Image
Stay connected anywhere, anytime	Wi-Fi Connectivity	<p>Use the Samsung SmartThings App* to get notified when the door's open or when you need a new water filter.</p> <p><small>*Available on Android and iOS devices. A Wi-Fi connection and a Samsung account are required.</small></p>	<p>Stay connected with SmartThings.*</p> <p><small>*Available on Android and iOS devices. A Wi-Fi connection and a Samsung account are required.</small></p>	
Easy access controls	ADA-Compliant Display	<p>Enjoy a stylish and easy way to access the controls. The display enhances the minimalist design as it is discreetly hidden inside. It is compliant with the standards of the Americans with Disabilities Act (ADA) as the controls are all within arm's reach and can be used with just one hand.</p>	<p>Provides seamlessly stylish easy access to controls, even if you have restricted movement.</p>	
Eco-friendly and energy-efficient	ENERGY STAR® Certified	<p>Save energy and money, while protecting the planet by reducing harmful carbon emissions. This refrigerator is ENERGY STAR® certified for its outstanding energy efficiency. Proven to use less power, without sacrificing performance or functionality.</p>	<p>Save energy and money, while protecting the environment.</p>	

# Product Specs

---

**RF25C5551 – 25 cu. ft. 33" 3-Door French Door Refrigerator  
with Beverage Center™**

## Review Mapping

SKU	Type	Color
RF25C5151SR/AA	French Door	Stainless Steel
RF25C5551SR/AA	French Door	Stainless Steel

## Related Product

Water Filter
HAF-QIN

# Spec Sheet

## RF25C5551SR

25 cu. ft. 3-Door French Door Refrigerator with Beverage Center™ & AutoFill Water Pitcher



## SAMSUNG

### Signature Features

**Beverage Center™ & AutoFill Water Pitcher**  
 Convenient access to refreshingly cool, filtered water is always in reach. The Beverage Center™ includes a dispenser and AutoFill Water Pitcher so you can press or pour—with the option to infuse with a flavor.

**Dual Auto Ice Maker**  
 Choose from cubed ice or Ice Bites™ that chill your drink faster.

**Large Capacity with SpaceMax™ Technology**  
 Store more with a spacious 25 cu. ft. interior\*. Features SpaceMax™ technology that gives you extra storage space inside without compromising energy efficiency. Keeps more food fresher longer.

\*Based on internal testing, compared to the RF20A model.

**Internal Water Filter**  
 It is integrated into the inside refrigerator wall and plumbed into the water supply. So it is easy to get a refreshing cold drink, with nothing showing on the outside.



Beverage Center™ & AutoFill Water Pitcher



Dual Auto Ice Maker

**Available Color**

Fingerprint Resistant Stainless Steel

**Design**

- Internal Water Filter
- Design
- Fingerprint Resistant Finish
- Recessed Handle
- LED Lighting
- Gallon Door Bins
- Tempered Glass Spill-Proof Shelves

**Technology**

- Beverage Center™ & AutoFill Water Pitcher
- Digital Inverter Technology
- Wi-Fi Connectivity
- Door Alarm
- Power Cool & Power Freeze

**Performance**

- Dual Auto Ice Maker with Ice Bites™
- SmartThings Energy\*
- All-Around Cooling

\*Available on Android and iOS devices. A Wi-Fi connection and a Samsung account are required.

**Rating**



ENERGY STAR® rated: 643 kWh/yr



## RF25C5551SR

25 cu. ft. 3-Door French Door Refrigerator with Beverage Center™ & AutoFill Water Pitcher

## SAMSUNG

### Installation Specifications

1. Measure the height, width and depth of the opening, making sure to include baseboards, molding tile, countertop overhang, etc. Check to be sure there is enough room to open the door (consider walls, islands or other obstacles when measuring).
2. Refer to illustration below to determine dimensions.
3. Allow 1½" of clearance on hinge side of refrigerator when installing next to a wall where door may make contact.
4. Allow 2" minimum clearance at rear for proper air circulation and water/electrical connections. Allow a ¾" minimum clearance at sides and top for ease of installation.
5. Ensure each door and entryway in the home is wide enough for the refrigerator to be moved through easily.

For optimal usage and ability to open refrigerator doors completely, do not install next to a wall.

Please note: The following dimensions and cutout information is for planning purposes only. For complete installation details, consult manual packed with product or download manual online at [samsung.com](http://samsung.com).

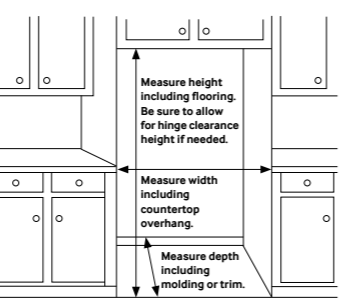

### Dimensions

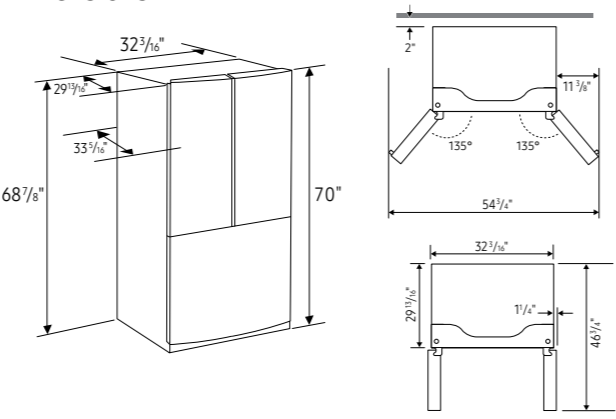

**Total Capacity: 24.5 cu. ft.**

**Refrigerator: 16.5 cu. ft.**

- 3 Tempered Glass Spill-Proof Shelves
- 2 Clear Crisper Drawers
- 7 Door Bins
  - Right Door: 1 Gallon Bin, 2 Regular Bins
  - Left Door: 1 Gallon Bin, 3 Regular Bins
- Surface Lighting

**Freezer: 8.0 cu. ft.**

- Dual Ice Maker in Freezer (Cubed Ice AND Ice Bites™)
- Ice Bucket with Cover and 1 Scoop
- Produces up to 5.6 lbs ice/day
- High-Efficiency LED Lighting

**Accessories**

Water Filter: HAF-QIN

**Warranty**

One (1) Year Parts and Labor on Refrigerator  
 Five (5) Years Parts and Labor on Sealed Refrigeration System Only\*  
 Ten (10) Years Parts and Five (5) Years Labor on Digital Inverter Compressor

\*Compressor, evaporator, condenser, drier and connecting tubing.

**Product Dimensions & Weight**

Dimensions (WxHxD with hinges and doors): 32½" x 70" x 33½"

Dimensions (WxHxD without hinges and door): 32½" x 68⅞" x 29⅜"

Weight: 248 lbs

**Shipping Dimensions & Weight (WxHxD)**

Dimensions: 32½" x 73" x 35"

Weight: 256 lbs

<b>Color</b> Fingerprint Resistant Stainless Steel	<b>Model #</b> RF25C5551SR	<b>UPC Code</b> 887276719023
---	-------------------------------	---------------------------------

Actual color may vary. Design, specifications, and color availability are subject to change without notice. Non-metric weights and measurements are approximate.  
 ©2022 Samsung Electronics America, Inc., 85 Challenger Road, Ridgefield Park, NJ 07660. Tel: 800-SAMSUNG, [samsung.com](http://samsung.com). Samsung is a registered trademark of Samsung Electronics Co., Ltd.

Spec Sheet - front

Spec Sheet - back

# Will It Fit? Guide

## 25 cu. ft. 3-Door French Door Refrigerator MODEL RF25C5551SR DIMENSIONS

**SAMSUNG**

### Be sure your new fridge will fit

Don't wait until delivery to be sure your new refrigerator will fit – both in your kitchen and through all doorways. This guide includes all pertinent measurements and clearances so you can buy with confidence.

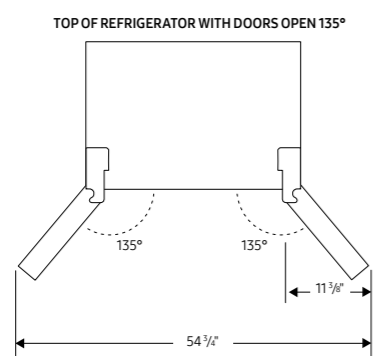
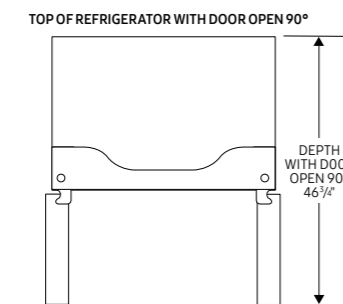
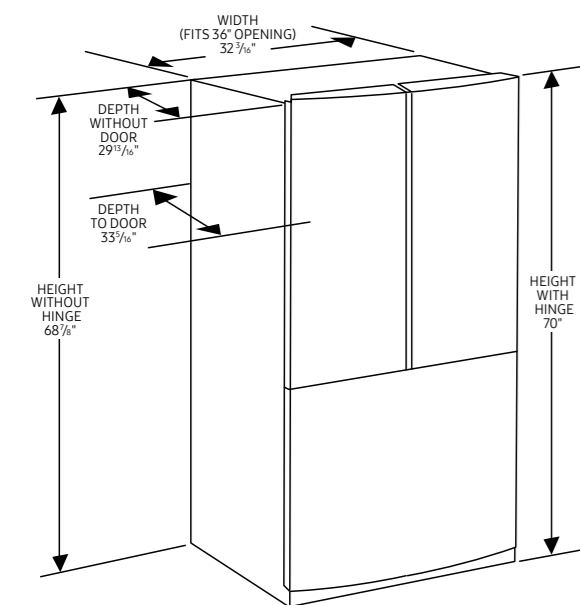

### Standard-Depth Refrigerator

Standard-depth refrigerators typically measure 30 to 35 inches in depth, as opposed to counter-depth refrigerators that sit flush with cabinetry.

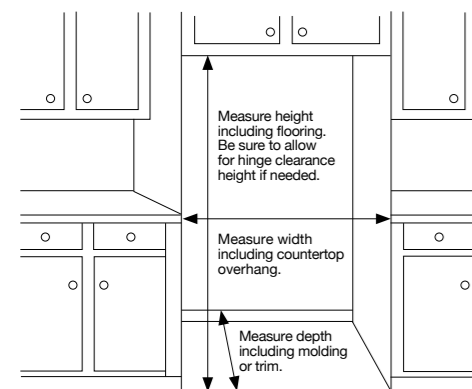

### Installation clearances

- ✓ Allow 3 3/4" of clearance when installing along a wall. This will allow for the door to open 90 degrees without the handle contacting the wall.
- ✓ Allow 2" minimum clearance at rear for proper air circulation and water/electrical connections.
- ✓ Allow a 3/8" minimum clearance at sides and top for ease of installation.

**For optimal usage and ability to open refrigerator doors completely, do not install next to a wall.**

Please note: The above dimensions and cutout information is for planning purposes only. For complete installation details, consult manual packed with product or download manual online at [samsung.com](http://samsung.com).

### Walk the delivery route

- ✓ Identify the narrowest opening that the appliance will travel through, from outside the home to the location where it will be installed.
- ✓ Appliance depth or width must be smaller than the width of the narrowest opening.

Will It Fit? Guide

# Energy Guide and User Manual

U.S. Government Federal law prohibits removal of this label before consumer purchase.

# ENERGYGUIDE

Refrigerator-Freezer

- Automatic Defrost
- Bottom-Mounted Freezer
- No Through-the-Door Ice

Samsung  
Model RF25C5551\*\*  
Capacity: 24.5 Cubic Feet

**Compare ONLY to other labels with yellow numbers.**  
Labels with yellow numbers are based on the same test procedures.

**Estimated Yearly Energy Cost**  
**\$90**

Cost Ranges	Models with similar features	\$74	\$96
	All models	\$66	\$116

**643 kWh**  
Estimated Yearly Electricity Use

- Your cost will depend on your utility rates and use.
- Both cost ranges based on models of similar size capacity.
- Models with similar features have automatic defrost, bottom-mounted freezer, and no through-the-door ice.
- Estimated energy cost based on a national average electricity cost of 14 cents per kWh.

ftc.gov/energy



Energy Guide

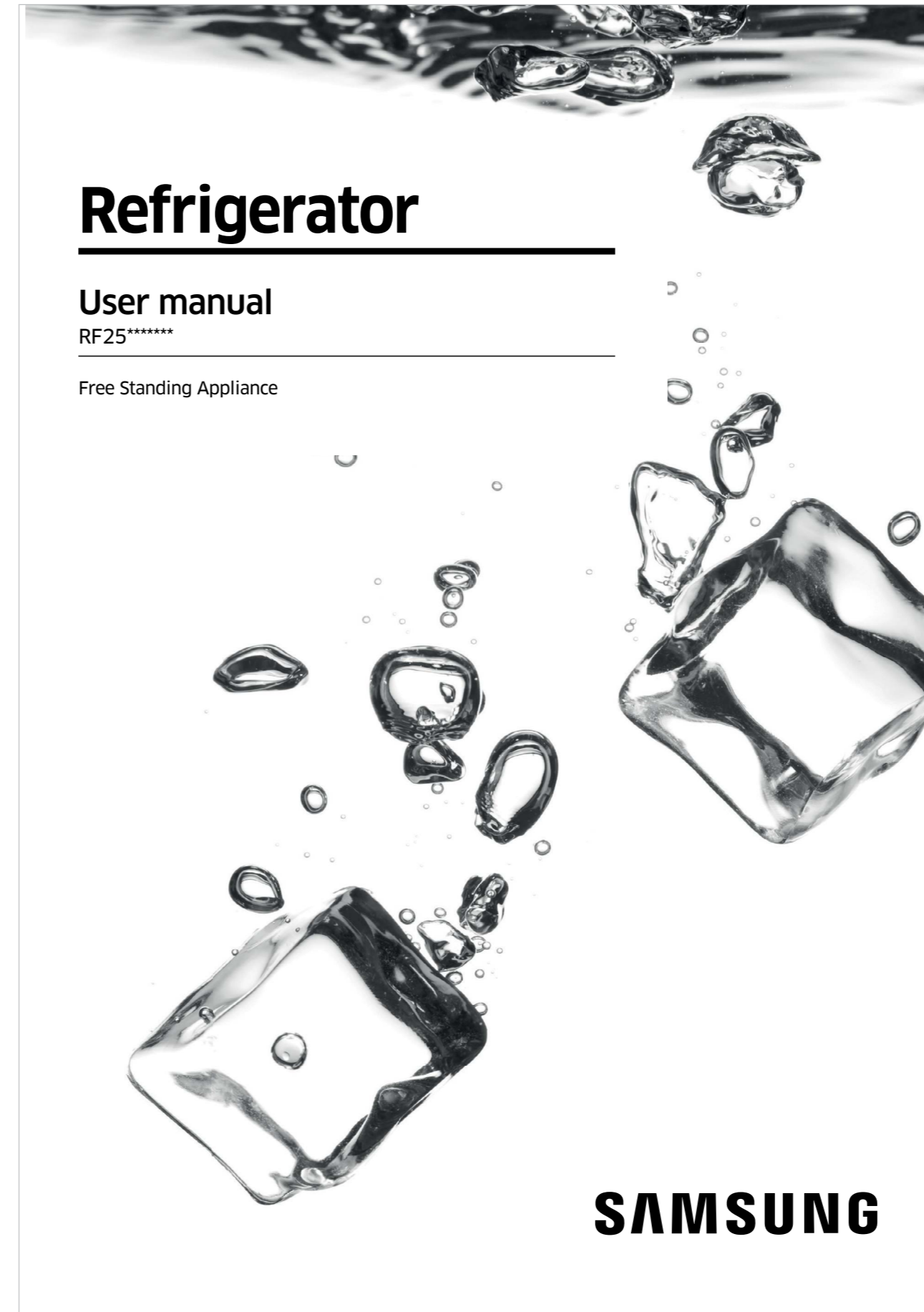

# Refrigerator

## User manual

RF25\*\*\*\*\*

Free Standing Appliance

**SAMSUNG**

User Manual

# Warranty

## LIMITED WARRANTY (U.S.A.) – SAMSUNG REFRIGERATOR

**Models:**  
RF25C5551SR

### LIMITED WARRANTY TO ORIGINAL PURCHASER WITH PROOF OF PURCHASE

This SAMSUNG brand product, as supplied and distributed by Samsung Electronics America, Inc. (SAMSUNG) and delivered new, in the original carton to the original consumer purchaser, is warranted by SAMSUNG against manufacturing defects in materials or workmanship for the limited warranty period of:

**One (1) year parts and labor**  
**Five (5) years parts and labor on Sealed Refrigeration System Only (Compressor, Evaporator, Condenser, Drier, and Connecting Tubing)**  
**Ten (10) years part and Five (5) years labor on Digital Inverter Compressor Only**

This limited warranty is valid only on products purchased and used in the United States that have been installed, operated, and maintained according to the instructions attached to or furnished with the product. To receive warranty service, the purchaser must contact SAMSUNG at the address or phone number provided below for problem determination and service procedures. Warranty service can only be performed by a SAMSUNG authorized service center. The original dated bill of sale must be presented upon request as proof of purchase to SAMSUNG or SAMSUNG's authorized service center to receive warranty service.

SAMSUNG will provide in-home service within the contiguous United States during the warranty period at no charge, subject to availability of SAMSUNG authorized servicers within the customer's geographic area. If in-home service is not available, SAMSUNG may elect, at its option, to provide transportation of the product to and from an authorized service center. If the product is located in an area where service by a SAMSUNG authorized servicer is not available, you may be responsible for a trip charge or required to bring the product to a SAMSUNG authorized service center for service.

To receive in-home service, product must be unobstructed and accessible to the service agent.

During the applicable warranty period, a product will be repaired, replaced, or the purchase price refunded, at the sole option of SAMSUNG. SAMSUNG may use new or reconditioned parts in repairing a product, or replace the product with a new or reconditioned product. Replacement parts and products are warranted for the remaining portion of the original product's warranty or ninety (90) days, whichever is longer. All replaced parts and products are the property of SAMSUNG and you must return them to SAMSUNG.

This limited warranty covers manufacturing defects in materials or workmanship encountered in normal household, noncommercial use of this product and shall not cover the following: damage that occurs in shipment, delivery, installation, and uses for which this product was not intended; damage caused by unauthorized modification or alteration of the product; product where the original factory serial numbers have been removed, defaced, changed in any way, or cannot be readily determined; cosmetic damage including scratches, dents, chips, and other damage to the product's finishes;

damage caused by abuse, misuse, pest infestations, accident, fire, floods, or other acts of nature or God; damage caused by use of equipment, utilities, services, parts, supplies, accessories, applications, installations, repairs, external wiring or connectors not supplied or authorized by SAMSUNG; damage caused by incorrect electrical line current, voltage, fluctuations and surges; damage caused by failure to operate and maintain the product according to instructions; in-home instruction on how to use your product; and service to correct installation not in accordance with electrical or plumbing codes or correction of household electrical or plumbing (i.e., house wiring, fuses, or water inlet hoses). The cost of repair or replacement under these excluded circumstances shall be the customer's responsibility.

Visits by an authorized servicer to explain product functions, maintenance or installation are not covered by this limited warranty. Please contact SAMSUNG at the number below for assistance with any of these issues.

### EXCLUSION OF IMPLIED WARRANTIES

IMPLIED WARRANTIES, INCLUDING THE IMPLIED WARRANTIES OF MERCHANTABILITY OR FITNESS FOR A PARTICULAR PURPOSE, ARE LIMITED TO ONE YEAR OR THE SHORTEST PERIOD ALLOWED BY LAW. Some states do not allow limitations on how long an implied warranty lasts, so the above limitations or exclusions may not apply to you. This warranty gives you specific rights, and you may also have other rights, which vary from state to state.

### LIMITATION OF REMEDIES

YOUR SOLE AND EXCLUSIVE REMEDY IS PRODUCT REPAIR, PRODUCT REPLACEMENT, OR REFUND OF THE PURCHASE PRICE AT SAMSUNG'S OPTION, AS PROVIDED IN THIS LIMITED WARRANTY. SAMSUNG SHALL NOT BE LIABLE FOR SPECIAL, INCIDENTAL OR CONSEQUENTIAL DAMAGES, INCLUDING BUT NOT LIMITED TO TIME AWAY FROM WORK, HOTELS AND/OR RESTAURANT MEALS, REMODELING EXPENSES, LOSS OF REVENUE OR PROFITS, FAILURE TO REALIZE SAVINGS OR OTHER BENEFITS REGARDLESS OF THE LEGAL THEORY ON WHICH THE CLAIM IS BASED, AND EVEN IF SAMSUNG HAS BEEN ADVISED OF THE POSSIBILITY OF SUCH DAMAGES. Some states do not allow exclusion or limitation of incidental or consequential damages, so the above limitations or exclusions may not apply to you. This warranty gives you specific rights, and you may also have other rights, which vary from state to state.

SAMSUNG does not warrant uninterrupted or error-free operation of the product. No warranty or guarantee given by any other person, firm, or corporation with respect to this product shall be binding on SAMSUNG.

To obtain warranty service, please contact SAMSUNG at:

<p>Samsung Electronics America, Inc. 85 Challenger Road Ridgefield Park, NJ 07660 1-800-SAMSUNG (726-7864) and <a href="http://www.samsung.com/us/support">www.samsung.com/us/support</a></p>
---

# Feature Icons

---

**RF25C5551 – 25 cu. ft. 33" 3-Door French Door Refrigerator  
with Beverage Center™**



# Feature Icons

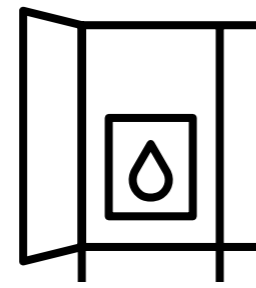

Beverage Center™

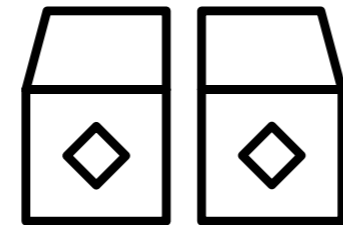

Dual Ice Maker

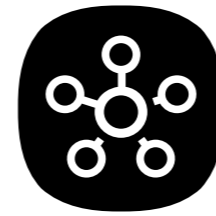

Smart Things

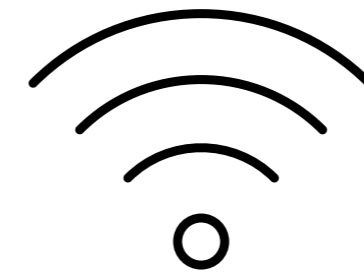

Wi-Fi Connectivity



10-Year Compressor Warranty\*

\*10 years of warranty coverage on the compressor.

**SAMSUNG**