

# SAMSUNG

# Product Guide

## 7710 Smart SLIM Over-the-Range Microwave/Hood Combination

ME11A7710DS

ME11A7710DG

Available in: Fingerprint Resistant Stainless Steel  
and Fingerprint Resistant Black Stainless Steel



# Table of Contents

## ME11A7710 – 1.1 cu. ft. Smart SLIM Over-the-Range Microwave with 550 CFM Hood Ventilation, Wi-Fi & Voice Control

### Product Overview

Product Overview	4
Carousel Image Order	5

### Product Messaging

Features and Benefits	7
Lifestyle Images	11
Product Videos	13

### Product Specs

Review Mapping and Related Products	15
Spec Sheet	16
User Manual	17

### Feature Icons

	19
--	----

# Product Overview

---

**ME11A7710 – 1.1 cu. ft. Smart SLIM Over-the-Range Microwave  
with 550 CFM Hood Ventilation, Wi-Fi & Voice Control**

# Product Overview

## Product Title

1.1 cu. ft. Smart SLIM Over-the-Range Microwave with 550 CFM Hood Ventilation, Wi-Fi & Voice Control

## Product Short Description (226 characters)

Free up space above your cooktop with the new, beautifully designed Smart SLIM Microwave. This combination microwave with ventilation hood packs in powerful performance and technology you love in a slim, space efficient size.

## Product Long Description (392 characters)

Free up space above your cooktop with the new, beautifully designed Smart SLIM Microwave. This combination microwave with ventilation hood fits into the same space as an under-the-cabinet hood, but despite its slim size, it has a sizeable 1.1 cu ft capacity. The SLIM Microwave packs in the powerful performance you need with all the technology that you love in a slim, space efficient size.



## Available Colors



**Fingerprint Resistant  
Stainless Steel**  
ME11A7710DS



**Fingerprint Resistant  
Black Stainless Steel**  
ME11A7710DG

# Carousel Image Order

### Easy Ad links

**ME11A7710DS:** R.COM - <https://dam.gettyimages.com/p/z0c3461/external?o=AND&q=ME11A7710DS%20RCOM>  
S.COM - <https://dam.gettyimages.com/p/z0c3461/external?o=AND&q=ME11A7710DS%20SCOM>  
360 Spins - <https://dam.gettyimages.com/p/z0c3461/external?o=AND&q=ME11A7710DS%20360%20Spins>

**ME11A7710DG:** R.COM - <https://dam.gettyimages.com/p/z0c3461/external?o=AND&q=ME11A7710DG%20RCOM>  
S.COM - <https://dam.gettyimages.com/p/z0c3461/external?o=AND&q=ME11A7710DG%20SCOM>  
360 Spins - <https://dam.gettyimages.com/p/z0c3461/external?o=AND&q=ME11A7710DG%20360%20Spins>

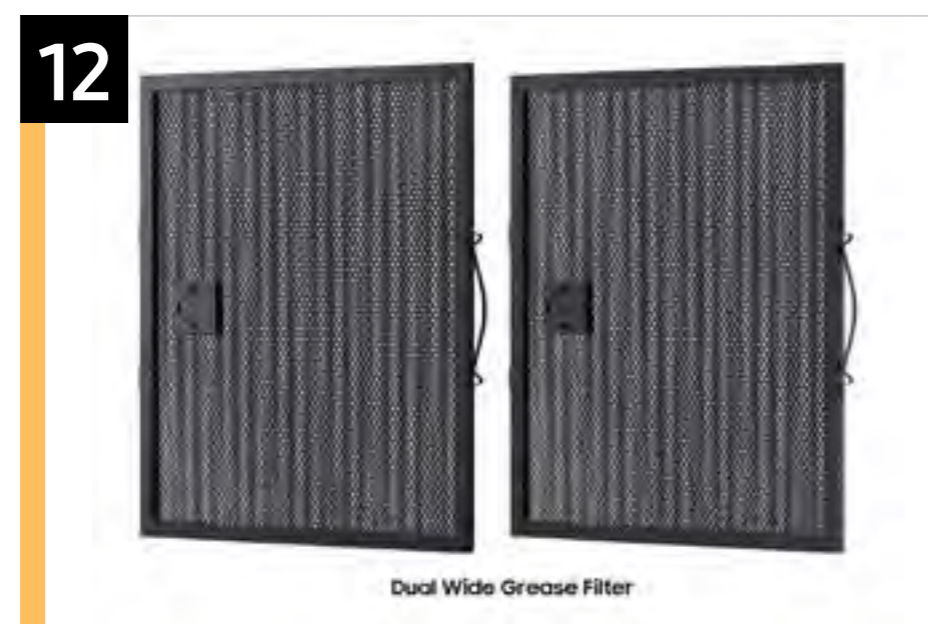



# Product Messaging



---

**ME11A7710 – 1.1 cu. ft. Smart SLIM Over-the-Range Microwave  
with 550 CFM Hood Ventilation, Wi-Fi & Voice Control**

## Features and Benefits – ME11A7710



Product Headline	Feature Name	Long Body Copy	Short Body Copy	Associated Image
<p><b>Powerful Ventilation</b></p>	<p>550 CFM Hood Ventilation</p>	<p>Even in its slim size, it's the most powerful ventilation system among over-the-range microwaves in the industry. The 550 CFM ventilation capacity quickly removes steam and odors that result from cooking.</p>	<p>The most powerful ventilation system among over-the-range microwaves. The 550 CFM ventilation capacity quickly removes steam and odors that result from cooking.</p>	 <p>Static and video assets available.</p>
<p><b>Make Cooking Simple With Smart Technology</b></p>	<p>Wi-Fi and Voice Control</p>	<p>Using a voice assistant with the SmartThings App, like Samsung Bixby, Amazon Alexa, or Google Assistant, you can tell your microwave what you want it to do.* The SmartThings App lets you monitor and adjust settings or control the ventilation and lighting from anywhere.</p> <p><small>*Available on Android &amp; iOS devices. A Wi-Fi connection and a Samsung account are required. Bixby is Samsung's brand of Artificial intelligence (AI), Amazon Alexa and all related logos are trademarks of Amazon.com, Inc. or its affiliates. Google is a trademark of Google LLC.</small></p>	<p>Adjust settings with your voice or with your smartphone by using the SmartThings App. Using a voice assistant, like Samsung Bixby, Amazon Alexa, or Google Assistant, you can tell your microwave what you want it to do.*</p> <p><small>*Available on Android &amp; iOS devices. A Wi-Fi connection and a Samsung account are required. Bixby is Samsung's brand of Artificial intelligence (AI), Amazon Alexa and all related logos are trademarks of Amazon.com, Inc. or its affiliates. Google is a trademark of Google LLC.</small></p>	 <p>Static and video assets available.</p>
<p><b>Brighten Up Your Cooktop</b></p>	<p>Wide LED Lighting Bar</p>	<p>At the simple press of a button, Samsung's brightest cooktop LED lighting illuminates evenly over your entire cooktop.</p>	<p>Press a button and Samsung's brightest cooktop LED lighting illuminates evenly over your entire cooktop.</p>	 <p>Static and video assets available.</p>

## Features and Benefits – ME11A7710 (Continued)

Product Headline	Feature Name	Long Body Copy	Short Body Copy	Associated Image
<p><b>No Need To Check If It's Done</b></p>	<p>Sensor Cook</p>	<p>Automatically adjusts cooking time for optimal results when you're not always certain how much time it takes to prepare your dish.</p>	<p>Automatically adjusts cooking time for optimal results.</p>	
<p><b>All Shine</b></p>	<p>Fingerprint Resistant Finish</p>	<p>Fingerprint resistant for an everyday beautiful finish.</p>	<p>Fingerprint resistant, beautiful finish.</p>	 <p>Note: Image should be customized by finish color for the respective model.</p>
<p><b>Seamless Control</b></p>	<p>Auto Connectivity</p>	<p>Conveniently sync your Samsung compatible microwave hood and cooktop through Auto Connectivity by using the SmartThings App. The hood fan and LED lighting will automatically turn on and off, when you turn your cooktop on or off, saving you time and extra effort while cooking.*</p> <p><small>*With these select Samsung Wi-Fi compatible range models only: Model numbers beginning with NE63A, NX60A, NE63T, NX60T, and NY60T. Wi-Fi connection and a Samsung SmartThings account are required.</small></p>	<p>Sync your Samsung compatible microwave hood and cooktop through Auto Connectivity by using the SmartThings App. The hood fan and LED lighting will automatically turn on and off, when you turn your cooktop on or off, saving you time while cooking.*</p> <p><small>*With these select Samsung Wi-Fi compatible range models only: Model numbers beginning with NE63A, NX60A, NE63T, NX60T, and NY60T. Wi-Fi connection and a Samsung Smart Things account are required.</small></p>	 <p>Static and video assets available.</p>



## Features and Benefits – ME11A7710 (Continued)

Product Headline	Feature Name	Long Body Copy	Short Body Copy	Associated Image
<p><b>More Power. Saves You Time*</b></p> <p><small>*As compared to other Samsung Over-the-Range Microwave oven models.</small></p>	<p>1100 Watt Output Power</p>	<p>Save time with impressive 1100W output power that enables you to cook quickly and evenly. Larger dishes are also cooked more thoroughly when the microwave has greater power performance.</p>	<p>Save time with impressive 1100W output power that enables you to cook quickly and evenly.</p>	
<p><b>A Hood That Helps Clean The Air</b></p>	<p>Dual Wide Grease Filter</p>	<p>Trap more airborne particles, such as oil and grease, improving hood performance with this large dual wide grease filter built into the hood.</p>	<p>Trap more airborne particles, such as oil and grease, improving hood performance with this dual wide grease filter built into the hood.</p>	
<p><b>Fits Your Cooking Essentials</b></p>	<p>1.1 cu. ft. Oven Capacity</p>	<p>This microwave oven cavity has a sizeable 1.1 cu. ft. capacity that can hold larger serving sizes.</p>	<p>This microwave oven has a 1.1 cu. ft. capacity that can hold larger serving sizes.</p>	 <p>Asset is an MP4 file.</p>

## Features and Benefits – ME11A7710 (Continued)

Product Headline	Feature Name	Long Body Copy	Short Body Copy	Associated Image
<p><b>Cooking With A Personalized Touch</b></p>	<p>SmartThings Cooking</p>	<p>Samsung’s SmartThings Cooking service makes meal planning a seamless process. Search, plan, purchase and prep weekly meals via the SmartThings App on your Family Hub™ refrigerator or smartphone.* SmartThings Cooking recommends personalized recipes based on preferences, shows what’s on hand and tracks recipe search history so you can plan meals for your family more efficiently. Download the SmartThings App to create shopping lists and add missing ingredients directly to your grocery cart for at-home delivery.</p> <p><small>*Available on Android and iOS devices. A Wi-Fi connection and a Samsung account are required.</small></p>	<p>Search recipes, plan meals, and add any missing ingredients to your grocery cart for at-home delivery with SmartThings Cooking.*</p> <p><small>*Available on Android and iOS devices. A Wi-Fi connection and a Samsung account are required.</small></p>	 <p>Static and video assets available.</p>

# Lifestyle Images

---

**ME11A7710 – 1.1 cu. ft. Smart SLIM Over-the-Range Microwave  
with 550 CFM Hood Ventilation, Wi-Fi & Voice Control**

# Lifestyle Images

Easy Ads link

<https://dam.gettyimages.com/p/z0c3461/external?o=AND&q=ME11A7710%20Lifestyle>



# Product Videos

---

**ME11A7710 – 1.1 cu. ft. Smart SLIM Over-the-Range Microwave  
with 550 CFM Hood Ventilation, Wi-Fi & Voice Control**

# Product Videos

## Easy Ads link

<https://dam.gettyimages.com/p/z0c3461/external?o=AND&q=ME11A7710%20Videos>

## Product Video



## Feature Videos

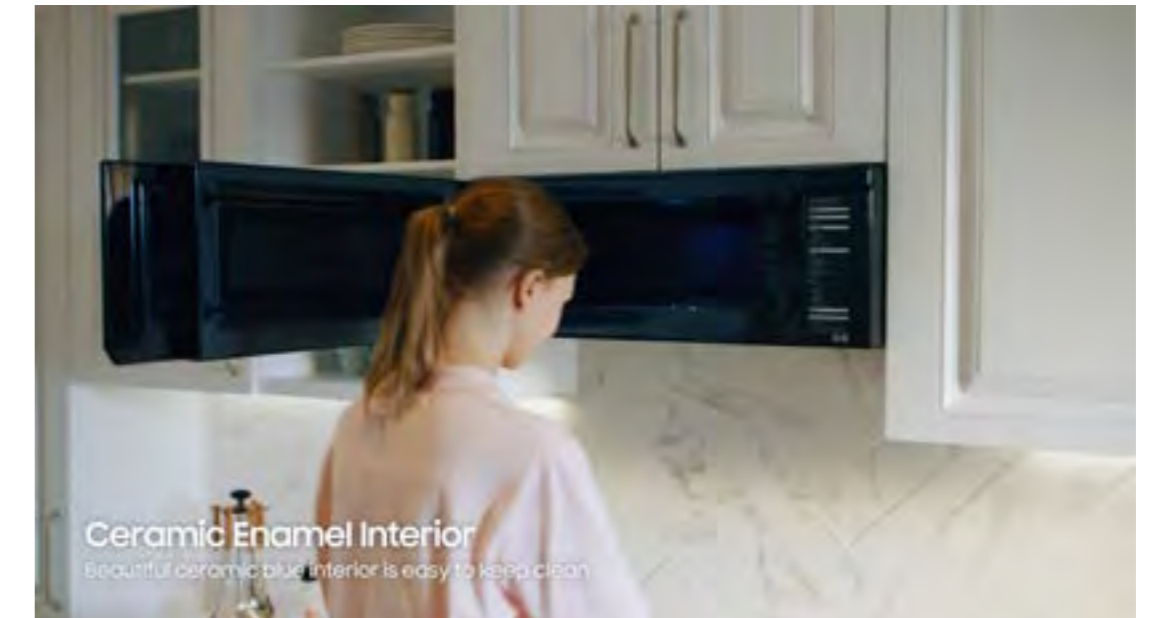

# Product Specs

---

**ME11A7710 – 1.1 cu. ft. Smart SLIM Over-the-Range Microwave  
with 550 CFM Hood Ventilation, Wi-Fi & Voice Control**

# Review Mapping

Model #	Type	Color
ME11A7710DS	SLIM Over-the-Range Microwave	Fingerprint Resistant Stainless Steel
ME11A7710DG	SLIM Over-the-Range Microwave	Fingerprint Resistant Black Stainless Steel

# Related Products

Ranges
NE63A6751SG
NE63A6751SS
NE63T8711SG
NE63T8711SS
NX60T8711SG
NX60T8711SS
NX60A6751SG
NX60A6751SS



# Spec Sheet

## Easy Ads link

[https://dam.gettyimages.com/p/z0c3461/external?o=AND&q=ME11A7710D\\*%20Spec%20sheet](https://dam.gettyimages.com/p/z0c3461/external?o=AND&q=ME11A7710D*%20Spec%20sheet)

## ME11A7710DS

1.1 cu. ft. Smart SLIM Over-the-Range Microwave with 550 CFM Ventilation, Wi-Fi & Voice Control



### Signature Features

**Slim Design**

- Open up space above your cooktop with the new, beautifully designed Smart SLIM Over-the-Range Microwave. This combination microwave and hood packs in powerful performance and technology you love in a slim, space-efficient size.

**Wi-Fi and Voice Control**

- Adjust settings with your voice or with your smartphone by using the SmartThings App\*. Using a voice assistant, like Samsung Bixby, Amazon Alexa, or Google Assistant, you can tell your microwave what you want it to do.

\*Available on Android & iOS devices. A Wi-Fi connection and a Samsung account are required. Bixby is Samsung's brand of artificial intelligence (AI). Amazon Alexa and all related logos are trademarks of Amazon.com, Inc. or its affiliates. Google is a trademark of Google LLC. This app also supports iOS 7 or later for iPhone models. SmartThings App available in App Store and Play Store.

**550 CFM Hood Ventilation with Hood Connectivity**

- The most powerful ventilation system among Over-the-Range microwaves. The 550 CFM ventilation capacity quickly removes steam, grease and odors that result from cooking.

## SAMSUNG

**Available Colors**

- Fingerprint Resistant Stainless Steel (shown)
- Fingerprint Resistant Black Stainless Steel



550 CFM Hood Ventilation



Wi-Fi and Voice Control

---

### Features

- Slim Design
- 550 CFM Ventilation System
- Wi-Fi and Voice Control
- SmartThings Cooking\*
- Sensor Cooking
- Ceramic Enamel Interior
- 1.1 cu. ft. Oven Capacity
- Glass Touch Controls
- 1100 Watts of Cooking Power
- 10 Power Levels

### Convenience

- LCD Display
- Clock (12 hr/24 hr) with Daylight Saving Time Adjustment
- Kitchen Timer
- Weight Option
- End Signal
- Interior Light: LED
- Cooktop Lighting: Bar LED
- Vent Fan Control: Boost/Hi/Mid/Lo/Off
- Child Safety Lock
- Sound On/Off
- Eco Mode (Reduces Standby Power)
- Wide Grease Filters (2)

### Auto Defrost/Power/Sensor Reheat

- Auto Cook
- Recessed Handle
- Change Filter Reminder

## ME11A7710DS

1.1 cu. ft. Smart SLIM Over-the-Range Microwave with 550 CFM Ventilation, Wi-Fi & Voice Control

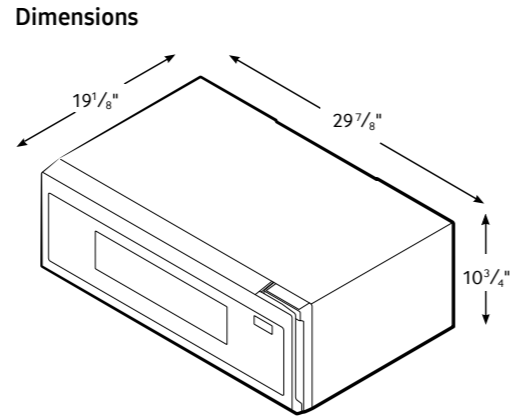

**Dimensions**

19 1/8" x 29 7/8" x 10 7/8"

## SAMSUNG

**Specifications**

- Oven Cavity: 1.1 cu. ft.
- Power Output: 1100W
- Power Consumption: 1650 W/14.5 Amps
- Power Source: 120 V/60 Hz
- Control Method: Glass Touch
- Display: White LCD
- Cooking Control: 10 Power Levels, Including Defrost
- Cooking Timer: Digital, up to 99 Minutes, 99 Seconds
- Microwave Distribution System: Turntable
- Glass Turntable Diameter: 11 1/2"
- Vent Fan: 4-Speed/550 CFM
- Vent Fan Control: Boost/Hi/Mid/Lo/Off
- Interior Light: LED
- Cooktop Lighting: Bar LED

**Warranty**

One (1) Year Parts and Labor  
Ten (10) Years Parts on Magnetron

**Product Dimensions & Weight (WxHxD)**

Cavity Dimensions: 18 1/2" x 6 5/8" x 14 5/8"  
Outside Net Dimensions: 29 7/8" x 10 3/4" x 19 1/8"  
Weight: 58.9 lbs

**Shipping Dimensions & Weight (WxHxD)**

Dimensions: 33 1/4" x 15 1/8" x 22 1/8"  
Weight: 65.3 lbs

Color	Model #	UPC Code
Fingerprint Resistant Stainless Steel	ME11A7710DS	887276551456
Fingerprint Resistant Black Stainless Steel	ME11A7710DG	887276577418

**Installing Your Microwave**

- This microwave oven is designed for adaptation to the following three types of ventilation:
  - Outside Top Exhaust (Vertical Duct)
  - Recirculating (Non-vented Ductless)
  - Outside Back Exhaust (Horizontal Duct)
- The space between the cabinets must be 30" wide and free of obstructions.
- This microwave oven is for installation over ranges up to 36" wide.
- The microwave must be level. Use a level to make sure the cabinet bottom is level. If the cabinets have a front overhang only, with no back or side frame, install the mounting plate down the same distance as the front overhang depth. This will keep the microwave level.



FOR EASIER INSTALLATION AND PERSONAL SAFETY, WE RECOMMEND THAT TWO PEOPLE INSTALL THIS MICROWAVE OVEN. IMPORTANT: Do not grip or use handle during installation. NOTE: If your cabinet is metal, use the nylon grommet around the power cord hole to prevent cutting of the cord. NOTE: We recommend using filler blocks if the cabinet front hangs below the cabinet bottom shelf. IMPORTANT: If filler blocks are not used, case damage may occur from overtightening screws. NOTE: When mounting the microwave oven, thread power cord through hole in bottom of top cabinet. Do not pinch cord or lift oven by pulling cord.

Actual color may vary. Design, specifications, and color availability are subject to change without notice. Non-metric weights and measurements are approximate. ©2021 Samsung Electronics America, Inc., 85 Challenger Road, Ridgefield Park, NJ 07660. Tel: 800-SAMSUNG. samsung.com. Samsung is a registered trademark of Samsung Electronics Co., Ltd.

Spec Sheet - front

Spec Sheet - back

# User Manual

Easy Ads link

[https://dam.gettyimages.com/p/z0c3461?o=AND&q=ME11A7710D\\*%20User%20Manual](https://dam.gettyimages.com/p/z0c3461?o=AND&q=ME11A7710D*%20User%20Manual)

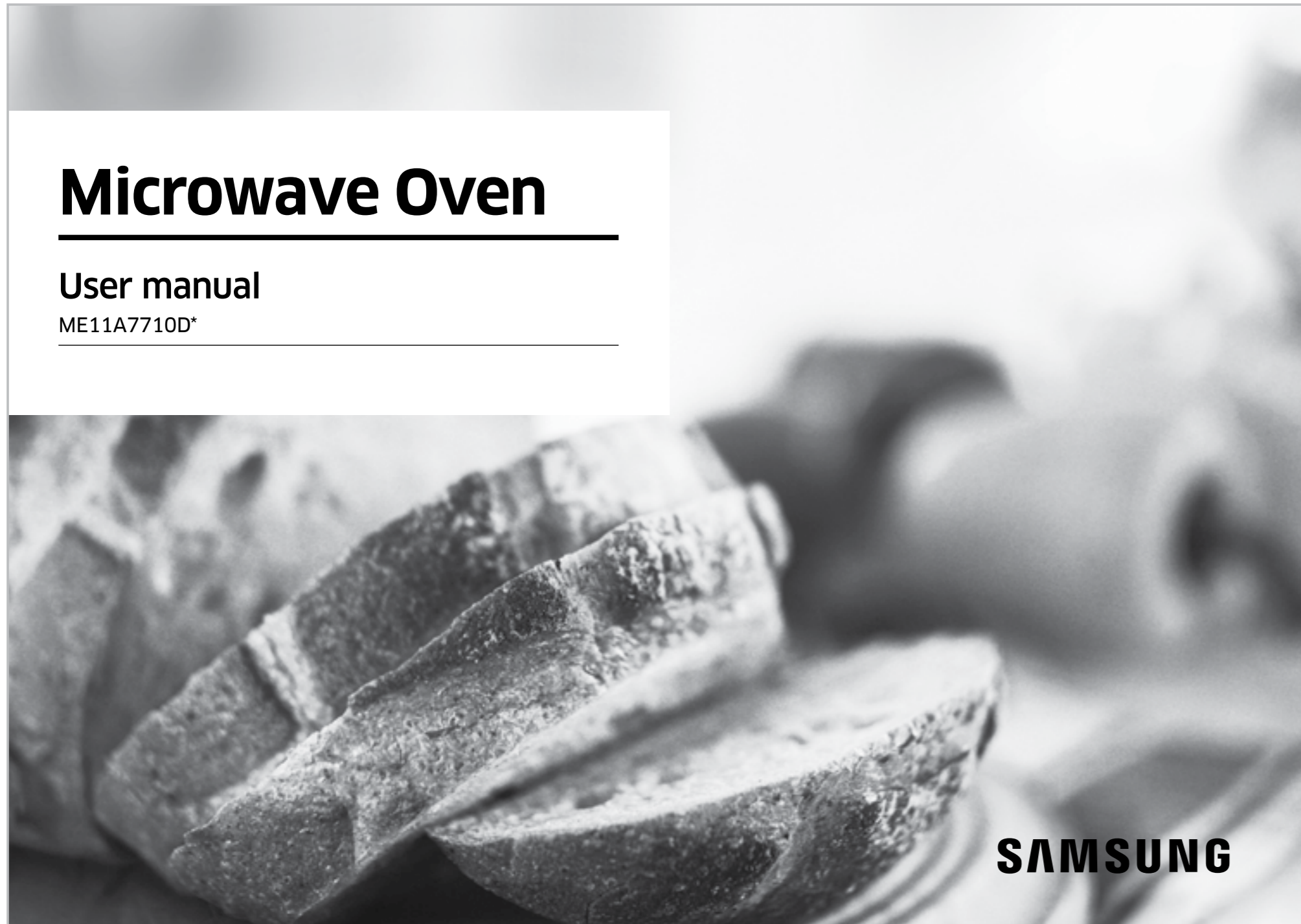

User Manual

# Feature Icons

---

**ME11A7710 – 1.1 cu. ft. Smart SLIM Over-the-Range Microwave  
with 550 CFM Hood Ventilation, Wi-Fi & Voice Control**

# Feature Icons

## Easy Ads link

<https://dam.gettyimages.com/p/z0c3461/external?o=AND&q=ME11A7710%20Icons>

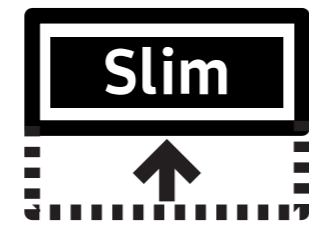

Space Efficient Size



550 CFM Hood Ventilation

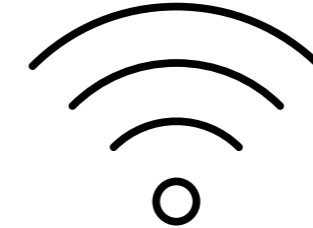

Wi-Fi Connectivity

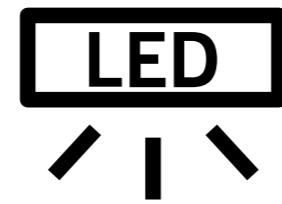

Wide LED Lighting Bar



Fingerprint Resistant Finish

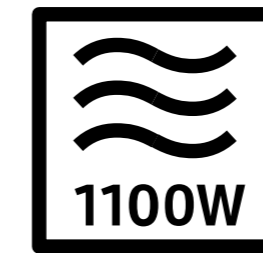

1100 Watt Output Power

**SAMSUNG**