

Assembly

▶ Go to support.BISSELL.com for assembly videos.

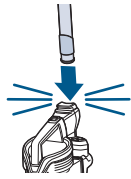

1. Insert handle into body until it clicks into place.

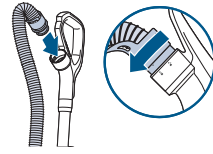

2. Attach hose to wand by twisting clockwise.

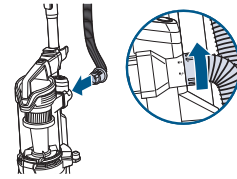

3. Attach hose to back of vacuum by twisting clockwise.

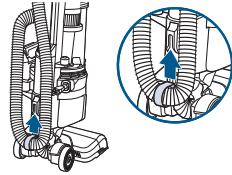

4. Attach hose clip to the body of the vacuum by clicking it into place.



5. The hose should sit on the vacuum without any twists as pictured.

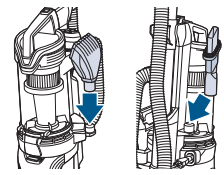

6. Attach tools to tool holders on vacuum.

Using Your Vacuum

▶ For additional ways to use your vacuum's features, check out support.BISSELL.com.

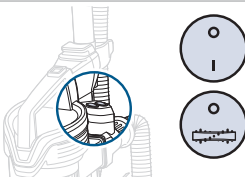

1. Power ON (I). Turn the brush roll ON (brush) for carpet cleaning and OFF (O) when vacuuming hard or delicate surfaces like hardwood, tile, small rugs, or frieze carpets with long fibers.



2. Step gently on base and pull the handle back to recline.

Note: The brush roll shuts OFF when vacuum is locked in upright position.

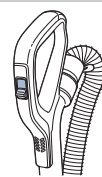

3. Use the carpet type control for optimized cleaning on high pile and low pile carpet. The control can be moved to the middle position for medium pile carpeting.

Automatic Cord Rewind

▶ If you have trouble with this feature, see our troubleshooting videos on support.BISSELL.com.

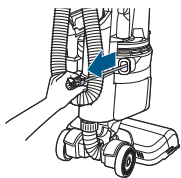

1. Gently pull the cord out. Do not pass the red mark on the cord. Plug cord into an outlet.

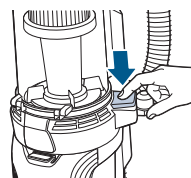

2. To retract, hold the plug and press the automatic cord rewind button.

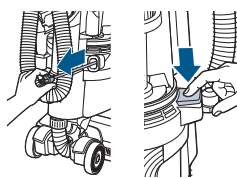

3. If cord doesn't fully retract, pull some of the cord out and press the button again.

Protecting the Vacuum's Motor

▶ For more assistance with your vacuum's motor protection, visit support.BISSELL.com.

There is an internal thermal protector in your vacuum that protects it from overheating. It controls the main vacuum motor only, not the brush motor. When it activates, the main motor will stop. The front lights and brush roll will stay on but there won't be any suction. If this happens, follow these steps:

1. Turn vacuum OFF and unplug from electrical outlet.
2. Check for the source of overheating problem (full dirt tank, dirty filters or a clog) and fix by following the steps in the "Vacuum won't pick up dirt" troubleshooting section.
3. When the motor cools for approximately 30 minutes, the thermal protector automatically resets and cleaning may continue. If the vacuum will not turn ON or the thermal protector continues to activate, contact Consumer Care.

Resetting the Brush Motor

▶ For more assistance with your vacuum's brush motor, visit support.BISSELL.com.

There is a circuit to protect the brush motor. If something becomes lodged in the foot and the brush shuts off, turn the cleaner off and unplug from the outlet. Remove the obstruction. The brush will automatically reset when the cleaner is plugged in and turned back on.

WARNING

- To reduce the risk of electrical shock:
- Turn power switch OFF and disconnect polarized plug from electrical outlet before performing maintenance or troubleshooting checks.
 - Before using your vacuum, make sure that the dirt tank is in locked position and that all filters, both pre- and post-filters, are in place. DO NOT operate your vacuum without these filters.
 - Do not operate vacuum with damp or wet filters. Allow components to dry before reassembling the dirt tank.
 - Do not use without filters in place.

Warranty

▶ Limited 5-year warranty, may vary by state. Visit support.BISSELL.com or call 1-800-237-7691 for complete warranty information.

Troubleshooting

For a comprehensive walkthrough of your product and support tips visit support.BISSELL.com.
Note: Any other servicing should be performed by an authorized service representative.

Every Purchase Saves Pets™

BISSELL proudly supports BISSELL Pet Foundation® and its mission to help save homeless pets. When you buy a BISSELL® product, you help save pets, too. We're proud to design products that help make pet messes, odors and pet homelessness disappear.

Visit BISSELLsavespets.com to learn more.



©2022 BISSELL Inc. All rights reserved.
Part Number 1628643 07/22 Rev0



MULTICLEAN™ ALLERGEN PET REWIND MODELS 3409, 3402

What's in the Box?	2
Assembly	3
Using Your Vacuum.....	3
Automatic Cord Rewind	3
Above Floor Cleaning.....	4
Emptying the Dirt Tank.....	4
Cleaning the Inner Cyclone Separator.....	4
Cleaning and Replacing the Filters.....	5
Protecting the Vacuum's Motor.....	6
Resetting the Brush Motor.....	6
Warranty.....	6
Troubleshooting.....	6

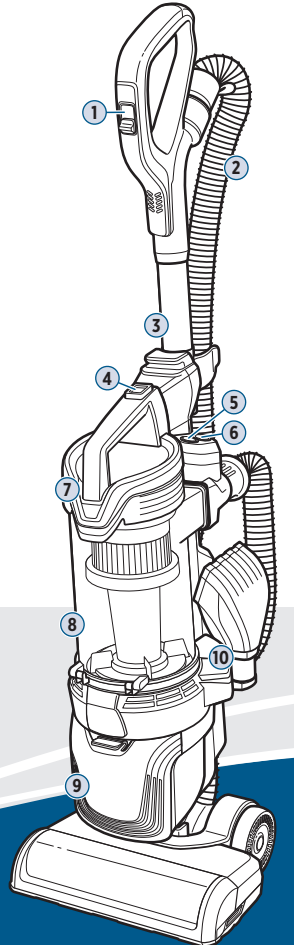

Product Overview

- | | |
|---------------------------------|------------------------|
| 1. Carpet Type Control | 8. Dirt Tank |
| 2. Hose | 9. Post-Motor Filter |
| 3. Quick Release Extension Wand | 10. Cord Rewind Button |
| 4. Dirt Tank Release Button | |
| 5. Power Switch | |
| 6. Brush Roll Switch | |
| 7. Pre-Motor Filter | |



Meet your new BISSELL product!

Go to support.BISSELL.com for a comprehensive walkthrough of your new purchase, including videos, tips, support, and more. Want to get started right away? This guide has all the information you need to set up your new product. Let's take a look...

IMPORTANT SAFETY INSTRUCTIONS

READ ALL INSTRUCTIONS BEFORE USING YOUR APPLIANCE.
Always connect to a polarized outlet (one slot is wider than the other). Unplug from outlet when not in use and before conducting maintenance. When using an electrical appliance, basic precautions should be observed, including the following:

⚠️ ⚠️ ⚠️ WARNING

TO REDUCE THE RISK OF FIRE, ELECTRIC SHOCK OR INJURY:

- Do not leave vacuum cleaner when it is plugged in. Unplug from outlet when not in use and before servicing.
- Do not use outdoors or on wet surfaces.
- Do not allow to be used as a toy. Close attention is necessary when used by or near children.
- Do not use for any purpose other than described in this user guide. Use only manufacturer's recommended attachments.
- Do not use with damaged cord or plug. If appliance is not working as it should, has been dropped, damaged, left outdoors, or dropped into water, have it repaired at an authorized service center.
- Do not pull or carry by cord, use cord as a handle, close a door on cord, or pull cord around sharp edges or corners. Do not run appliance over cord. Keep cord away from heated surfaces.
- Do not unplug by pulling on cord. To unplug, grasp the plug, not the cord.
- Do not handle plug or vacuum cleaner with wet hands.
- Do not put any object into openings. Do not use with any opening blocked; keep openings free of dust, lint, hair, and anything that may reduce air flow.
- Keep hair, loose clothing, fingers, and all parts of body away from openings and moving parts.
- Turn all controls OFF before plugging or unplugging vacuum cleaner.
- Use extra care when cleaning on stairs.
- Do not use to pick up flammable or combustible materials (lighter fluid, gasoline, kerosene, etc.) or use in areas where they may be present.

- Do not use vacuum cleaner in an enclosed space filled with vapors given off by oil-based paint, paint thinner, some moth-proofing substances, flammable dust, or other explosive or toxic vapors.
- Do not use to pick up toxic material (chlorine bleach, ammonia, drain cleaner, etc.).
- Do not pick up anything that is burning or smoking, such as cigarettes, matches or hot ashes.
- Do not use without filters in place.
- Do not pick up hard or sharp objects such as glass, nails, screws, coins, etc.
- Use only on dry, indoor surfaces.
- Keep appliance on a level surface.
- Do not carry the vacuum cleaner while it is running.
- Unplug before connecting or disconnecting the TurboBrush® tool.
- Plastic film can be dangerous. To avoid danger of suffocation, keep away from children.
- Do not plug in your vacuum cleaner until you are familiar with all instructions and operating procedures.
- Turn power switch OFF and disconnect polarized plug from electrical outlet BEFORE performing maintenance or troubleshooting checks.
- Hold plug when rewinding onto cord reel. Do not allow plug to whip when rewinding.
- When finished using the product, rewind cord for storage. Store unit indoors in a dry location in an area where the product is not likely to get damaged.
- Any other maintenance or servicing not included in this manual should be performed by an authorized service representative.

SAVE THESE INSTRUCTIONS





THIS MODEL IS FOR HOUSEHOLD USE ONLY.

COMMERCIAL USE OF THIS MACHINE VOIDS THE MANUFACTURER'S WARRANTY.

THIS APPLIANCE HAS A POLARIZED PLUG To reduce the risk of electric shock, this appliance has a polarized plug (one blade is wider than the other). This plug will fit in a polarized outlet only one way. If the plug does not fit fully in the outlet, reverse the plug. If it still does not fit, contact a qualified electrician to install a proper outlet. Do not change the plug in any way.

What's in the Box?

Standard accessories may vary by model. To identify what should be included with your purchase, please refer to the "Carton Contents" list located on the carton top flap.

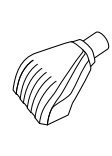
				
Vacuum Base	Handle	Stretch Hose	2-in-1 Dusting Brush & Crevice Tool	Pet TurboEraser® Tool

Above Floor Cleaning

Visit support.BISSELL.com to see all the ways you can use your vacuum's tools.

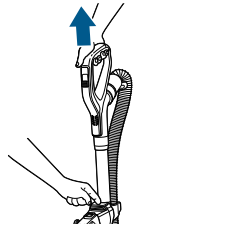
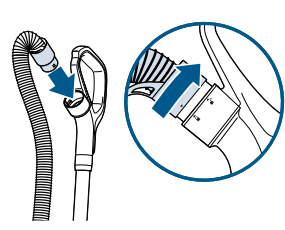
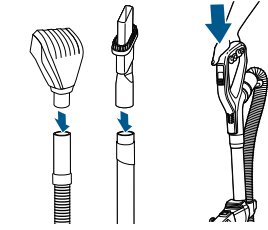
		
1. Push the release button to remove extension wand and attach desired tool.	2. The hose can be removed from the extension wand. Twist hose cuff counter-clockwise and remove from handle.	3. Attach desired tool. Note: For optimal use, attach the Pet TurboEraser® Tool to the hose instead of wand. Reinstall wand by sliding until it clicks into place. Reattach hose to handle if needed.

Emptying the Dirt Tank

For additional maintenance steps, visit support.BISSELL.com.

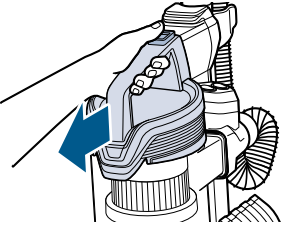
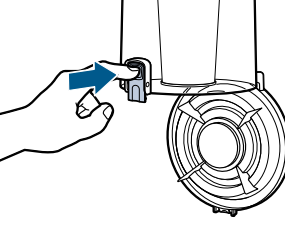
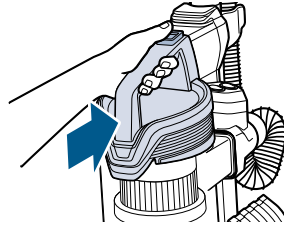
		
1. Press the release button and pull the tank away.	2. Hold the tank over a trash bin and press the empty button. Once emptied, snap bottom back into place.	3. Reinstall tank by inserting bottom first and pushing top back until it clicks into place.

Cleaning the Inner Cyclone Separator

We have additional maintenance videos for your machine on support.BISSELL.com.

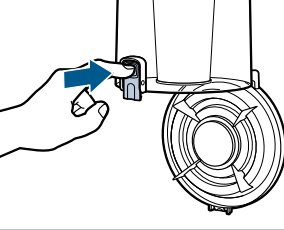
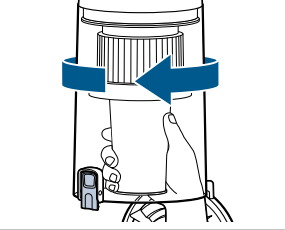
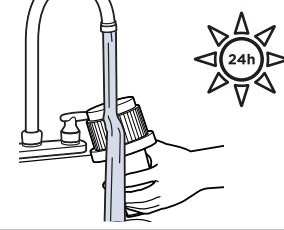
		
1. Hold the dirt tank over a trash container. Press the bottom release button to empty.	2. Twist separator counter-clockwise and pull down to remove.	3. Tap separator against inside of trash container and rinse under warm water, if necessary. Let dry completely before reinstalling.

Cleaning and Replacing the Filters

Visit BISSELL.com to find replacement filters.

Pre-Motor Filter

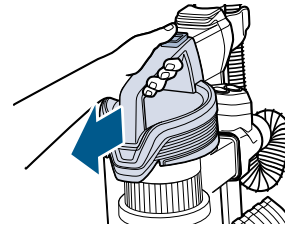
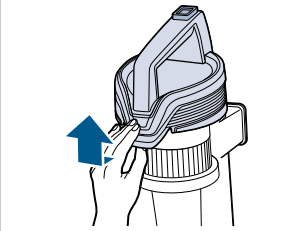
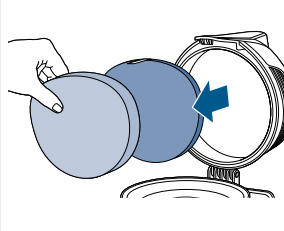
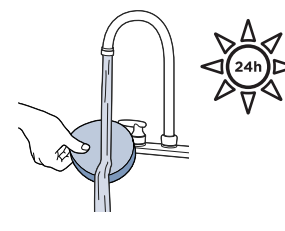
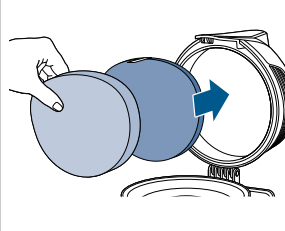
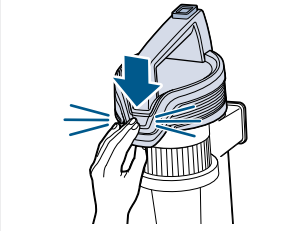
		
1. Press the dirt tank release button and pull away from vacuum.	2. Open the tank lid by lifting up.	3. Remove pre-motor filters from top of dirt tank lid by pulling out.
		
4. Clean with mild detergent, rinse and squeeze all excess water. Allow filters to dry completely before reinserting.	5. Return pre-motor filters to the top of the dirt tank. Put the thin flat filter with the white tab in first, then put the thick foam filter in.	6. The lid will click into place when tank lid is closed securely.

Post-Motor Filter

For optimal performance, replace the filter every 6 months.

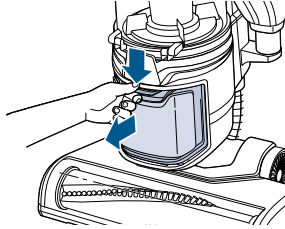
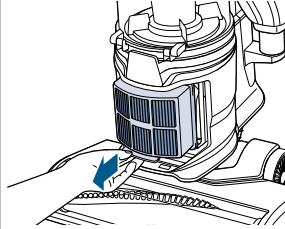
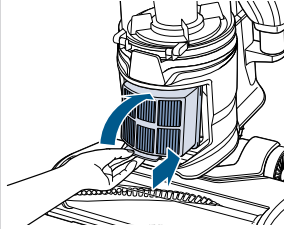
		
1. Press down on tab to remove post-motor filter cover and pull away from vacuum.	2. Press tab on bottom of filter and pull out to remove from vacuum. Remove debris from filter by tapping on the side of a trash container. This pleated filter should NOT be washed.	3. When reassembling, be sure to lock the filter back into place by aligning the top of the filter first, then clicking the bottom into place.

⚠️ WARNING

- To reduce the risk of electrical shock:
- Turn power switch OFF and disconnect polarized plug from electrical outlet before performing maintenance or troubleshooting checks.
 - Before using your vacuum, make sure that the dirt tank is in locked position and that all filters, both pre- and post-filters, are in place. Do not operate vacuum with damp or wet filters. Allow components to dry before reassembling the dirt tank.
 - Do not use without filters in place.