

# SKSCW181RP

## 18-INCH INTEGRATED COLUMN WINE REFRIGERATOR



### WINE CAVE TECHNOLOGY™

Carefully tailored to mimic the ideal environment of historic wine caves, our exclusive design minimizes temperature fluctuations, reduces vibration, limits light passing through, and locks in humidity.

### PRECISE PRESERVATION

Ingenuous features like an inverter linear compressor and metal interior help to keep your collection cool while maintaining the lowest temperature fluctuation among leading brands\* and vibration minimized to less than 2 gal (cm/s<sup>2</sup>).

### LIGHT AND HUMIDITY CONTROL

Dark-tinted, triple pane glass protects wine from damaging UV light while humidity control boosts humidity to optimum levels, helping to preserve quality and taste.

### INDEPENDENT TEMPERATURE ZONES

Two Independent temperature zones keep both white and red wines at the right temperature to bring out the very best taste.

### TOUCH DISPLAY LIGHTING

Showcase an entire collection with a touch of the door. LED lights are activated by gently tapping the door or with the mobile app. Choose from four display settings including, Presentation, Upper, Lower, and All.

### TRUEFIT™ INTEGRATED DESIGN

Every integrated column features an intelligent, symmetrical design that allows for proud or flush installation.

### ECO FRIENDLY

Engineered to reduce environmental impact with HFC / HCFC free refrigerant, insulation and recyclable materials, while using just 250 kWh/yr — the lowest energy consumption in the industry.\*

### Style

Door Style	Panel Ready
Door Swing	Reversible (Ships Right Hinge)
Interior Cabinet Finish	Metal

### Innovation

WiFi-Enabled for SmartThinQ® Control with iPhone / Android App	Yes
InstaView™ Window (Knock Twice to See Inside)	Yes
Wine Cave Technology™	Yes
Inverter Linear Compressor	Yes

### Performance

Temperature Zones	2
Operating Temperatures	41° to 64° F
Humidity Control	Yes

### Modes

Sabbath, Demo, Power On / Off, Temp Control, Smart Diagnosis, WiFi

High Altitude Compatibility	Yes
-----------------------------	-----

### Capacity and Storage

Bottle Capacity (750 ml)	71
Storage Shelves	11
Shelf Material	Beech Wood with Metal Accents
Presenter Shelf	1

\*When compared to leading brand wine refrigerators of similar size and capacity as of Feb. 2019.

© 2019 Signature Kitchen Suite. All rights reserved. Design, features and specifications are subject to change without notice. Specifications are for planning purposes only. Consult the product's installation instructions for final dimensional data and other details prior to making cutouts or custom panels. Consult with a heating and ventilation engineer for your specific ventilation requirements. Non-metric weights and measurements are approximate. Smart features require Internet access.

1-855-790-6655 | [www.signaturekitchensuite.com](http://www.signaturekitchensuite.com)

# SKSCW181RP

## 18-INCH INTEGRATED COLUMN WINE REFRIGERATOR

### General Features

Digital Touch Controls w/White LED Display	Yes
Hidden LED True-View™ Interior Lighting	Yes
Presenter Shelf Lighting	Yes
Maximum Sound Level	38 dBA
Star-K Certified Sabbath Mode	Yes

### Installation Features

Four Point Front Adjustable with 8 Wheels	Yes
Attachment Method to Cabinetry	Top with No Visible Screws
Front Serviceable	Yes
Anti-tip Bracket Included	Yes

### Technical Specs

Required Power Supply	115 V, 60 Hz, 15 or 20 Amp
Plug Type	3-Prong
Power Cord Length	86 1/2"

### Dimensions and Weight

Overall Width (inches)	17 1/2"
Overall Height (inches)	83 1/2" Min. – 84 1/2" Max.
Overall Depth Without Panel or Handles (inches)	23 7/8"
Net Weight (approx.)	306 lbs.
Shipping Weight (approx.)	353 lbs.

### Optional Accessories

Stainless Steel Panel / Handle / Toekick Kit	SKSWK185RS (Right Hinge, Left Handle) SKSWK185LS (Left hinge, Right Handle)
Joining Kit for Dual Installation	SKSFJ800P
Retrofit Frame Kit	SKSFK800CS
Brushed Aluminum Handle Medium – 31 11/16" Long – 48" (For Columns)	SKSHK310HS SKSHK480HS

### Warranty Summary\*

Limited Warranty, Parts & Labor	2 Years
Additional 1 Year When Product Registration is Completed Online with Owner Opt-in for Wi-Fi Monitoring	Yes
Limited Warranty on Sealed System, Parts and Labor	5 Years
Limited Warranty on Sealed System, Parts Only	10 Years

\*These warranties give you specific legal rights and you may have other rights that vary from state to state. For complete warranty details, refer to your Use & Care manual.

# SKSCW181RP

## 18-INCH INTEGRATED COLUMN WINE REFRIGERATOR

### CUTOUT DIMENSIONS – FLUSH OR PROUD INSTALLATION

#### SINGLE COLUMN

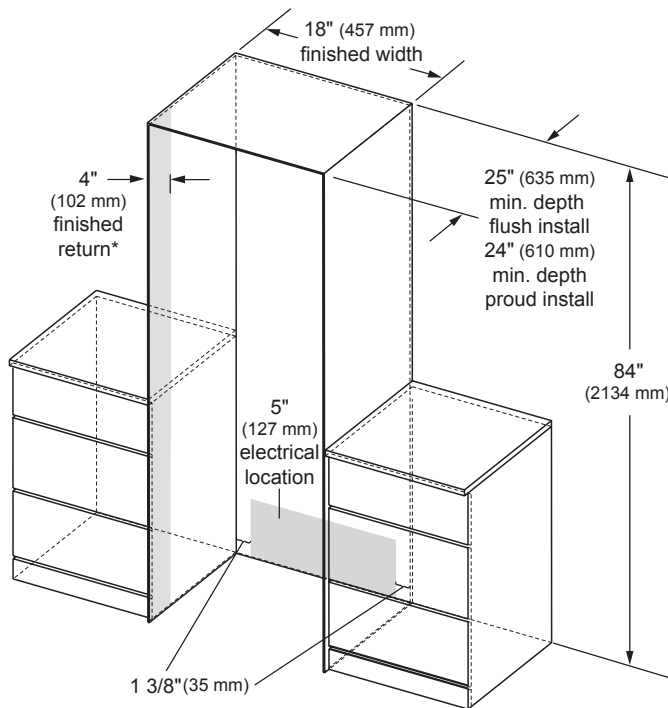

\* A minimum 4" (102 mm) finished return that matches the cabinet exterior is recommended on all sides and the top of the cutout opening. The shaded area will be visible after installation.

#### Notes

Wine refrigerator can be installed flush or proud with 3/4" custom panel or optional stainless steel panel kit.

**Flush** – With a 25" (635 mm) cutout depth, the front face of the wine refrigerator fits flush with 25" (635 mm) depth adjacent cabinets.

**Proud** – With a 24" (610 mm) depth cutout, the front face of the wine refrigerator extends approximately 3/4" (19 mm) beyond 24" (610 mm) depth adjacent cabinets.

#### Electrical

A 115V, 60Hz., 15 or 20 amp power supply is required. An individual properly grounded branch circuit or circuit breaker is recommended. Install a properly grounded 3-prong electrical receptacle recessed into the back wall. Electrical must be located on rear wall as shown.

**Note:** GFI (ground fault interrupter) is not recommended.

### INSTALLATION CLEARANCES

#### TOP VIEW

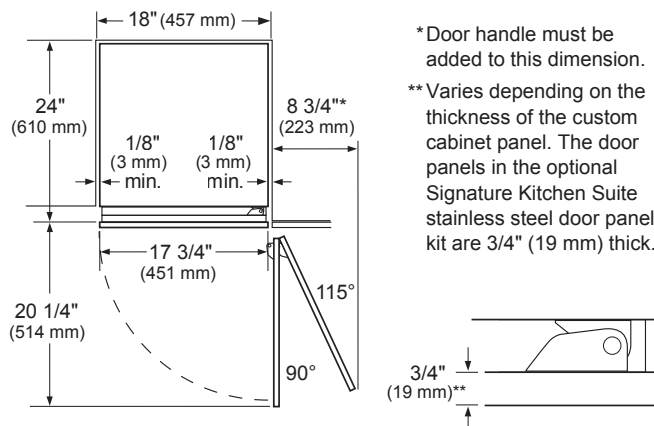

\* Door handle must be added to this dimension.

\*\*Varies depending on the thickness of the custom cabinet panel. The door panels in the optional Signature Kitchen Suite stainless steel door panel kit are 3/4" (19 mm) thick.

#### Notes

**Door Swing Clearances** – The installation must allow for clearances to adjacent walls or cabinets. This wine refrigerator is equipped with a 2-position door stop. The factory-set 115° door swing can be adjusted to 90° if clearance to adjacent cabinets or walls is restricted.

**Door Handle Clearances** – The Door Handle depth must be added to the dimension noted to determine the total clearances required from adjacent cabinets or walls. This clearance will vary depending on the custom handle used. When using the Stainless Steel Door Panel Kit w/Handle or the Brushed Aluminum Handle (optional accessories), the door handle clearance with door open 115° is 11" (279 mm).

# SKSCW181RP

## 18-INCH INTEGRATED COLUMN WINE REFRIGERATOR

### OVERALL PRODUCT DIMENSIONS

#### FRONT VIEW

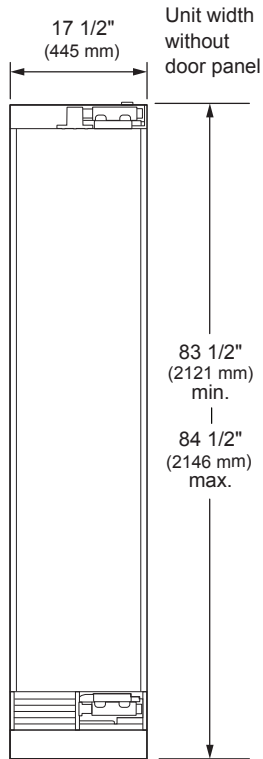

#### SIDE VIEW

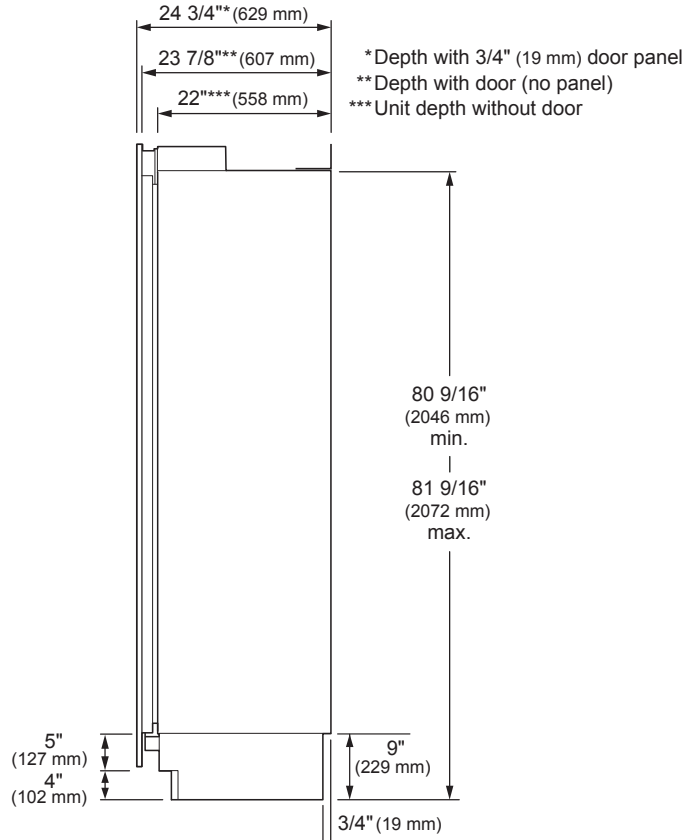

#### TOP VIEW

##### DOOR OPEN 90°

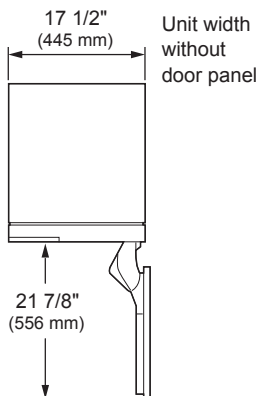

##### DOOR OPEN 115°

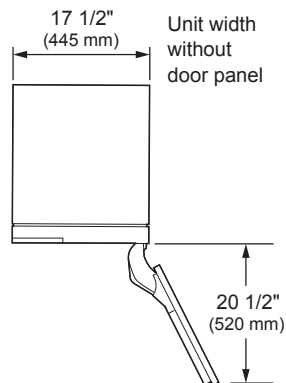

# SKSCW181RP

## 18-INCH INTEGRATED COLUMN WINE REFRIGERATOR

### CUSTOM PANEL DIMENSIONS – FLUSH INSTALLATION

#### 18-INCH INTEGRATED COLUMN

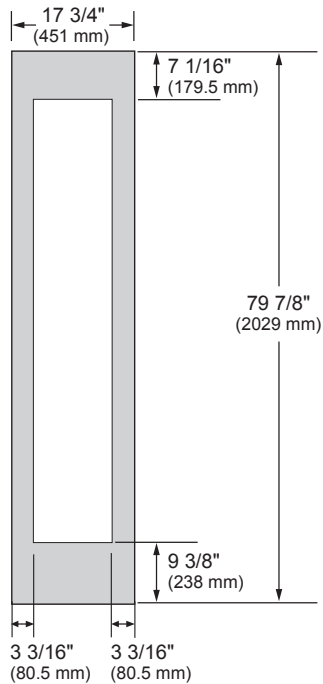

#### Notes

These units are designed to be customized with decorative panels. Field-installed custom door panels or an optional Stainless Steel Panel Kit is required.

**For Custom Panels:** Use templates provided with units to pre-drill holes for mounting panel brackets (provided with unit). Adjustment screws and instructions also provided with units.

Maximum Total Door Panel Weights:  
24-Inch Integrated Column – 22 lbs.  
18-Inch Integrated Column – 21 lbs.

#### Design Tips

4" (102 mm) will be visible on the interior sides of the furniture return. It is recommended that both sides of each cutout panel be finished to match the cabinet exterior.

If using custom panels, a custom toe kick is required. The bottom of case is unfinished.

**Door Handles:** Handles are not included with the units. Custom handles are required for installation. Brushed Aluminum Handles are available as an optional accessory.

# SKSCW181RP

## 18-INCH INTEGRATED COLUMN WINE REFRIGERATOR

### OPTIONAL ACCESSORIES – FLUSH OR PROUD INSTALLATION



#### **Stainless Steel Panel Kit for 18-inch Integrated Column Wine Refrigerator**

This unit can be installed with an optional Stainless Steel Panel Kit. Kit includes one door panel, one toe kick and one handle. Order right or left hinge option, depending on desired installation.

#### **SKSWK185RS** – 18" Wine Column Stainless Kit, Right Hinge

(Horizontal brushed hairlines for right hinge installation, opening from left to right)

#### **SKSWK185LS** – 18" Wine Column Stainless Kit, Left Hinge

(Horizontal brushed hairlines for left hinge installation, opening from right to left)

#### **SKSFK800CS** – Frame Kit

This unit can be installed in a 24" (610 mm) deep cutout with an optional frame kit. This kit includes two 80" (2032 mm) brushed aluminum side trim pieces. Each trim piece is 5" (127 mm) deep with a 1/8" (3 mm) front face.

#### **Handles for Use With Custom Panels**

**SKSHK310HS** – 31 11/16" (805 mm) Medium Handle – Brushed Aluminum

**SKSHK480HS** – 48" (1219 mm) Long Handle – Brushed Aluminum

#### **Dual Installation (joining) Kit**

**SKSFJ800P** – When this wine column is installed with other column refrigerator or freezer, this kit is required for the installation.

#### **Design Tips**

The Stainless Steel Panel Kit may be used in a flush 25" (635 mm) cutout depth installation or in a proud 24" (610 mm) cutout depth installation.

For retrofit/replacement installations where the existing cutout is 24" (610 mm) deep, the optional frame kit is recommended.