

SAMSUNG

Product Guide

7150 Series Laundry

WA54CG7150 - Washer

DVE54CG7150 - Electric Dryer

DVG54CG7150 - Gas Dryer

Available in Brushed Navy and White



Table of Contents

WA54CG7150 - Top Load Washer

Product Overview

Product Overview	4
Carousel Image Order	5

Product Messaging

Features and Benefits	8
Lifestyle Images	14

Product Specs

Related Products	17
Spec Sheet	18
Energy Guide	19
User Manual and Warranty	20

Feature Icons	22
---------------	----

DVE54CG7150 - Electric Dryer

DVG54CG7150 - Gas Dryer

Product Overview

Product Overview	24
Carousel Image Order	25

Product Messaging

Features and Benefits	28
-----------------------	----

Product Specs

Related Products and Accessories	33
Spec Sheets	34
User Manual and Warranty	35

Feature Icons	37
---------------	----

Price Tag Guidance	38
--------------------	----

Product Overview

WA54CG7150AD
WA54CG7150AW

**5.4 cu. ft. Smart Top Load Washer with Pet Care Solution
and Super Speed Wash**

Product Overview

Product Title

5.4 cu. ft. Smart Top Load Washer with Pet Care Solution and Super Speed Wash

Product Description

Samsung's 5.4 cu. ft. Extra-Large Capacity Smart Top Load Washing Machine is equipped with Pet Care Solution, which removes 6X more pet hair¹ with Pet Care Wash Cycle that loosens hair to be trapped by dual pet hair filters. With Super Speed Wash, powerfully clean a full load of laundry in just 28 minutes without sacrificing cleaning performance.²

- Pet Care Solution – Remove 6X more pet hair¹
- Super Speed Wash – Thoroughly wash a full load in just 28 minutes²
- Wi-Fi Connectivity with SmartThings – Remotely start, schedule and receive end of cycle alerts to your smartphone³
- Active WaterJet – Easily pretreat with a built-in water faucet

¹ WA7150C using the Pet Care Wash cycle and Pet Hair Filter compared to WA7700A using Normal cycle.

² Based on using Super Speed on a Normal Cycle with an 8lb load.

³ Requires wireless network, Samsung account and SmartThings App. The Samsung SmartThings App supports Android OS 4.0 (ICS) or later which is optimized for Samsung smartphones (Galaxy S and Galaxy Note series). This app also supports iOS 7 or later for iPhone models. SmartThings App available in App Store and Play Store.

Easy Ads Links

Brushed Navy Washer: <https://dam.gettyimages.com/p/z0c3461/digital-appliances?o=AND&q=WA54CG7150AD>

White Washer: <https://dam.gettyimages.com/p/z0c3461/digital-appliances?o=AND&q=WA54CG7150AW>

Available Colors



Brushed Navy

Model Number: WA54CG7150AD

UPC: 887276760360



White

Model Number: WA54CG7150AW

UPC: 887276760377



Carousel Image Order

WA54CG7150AD



Alternate asset without banner available.

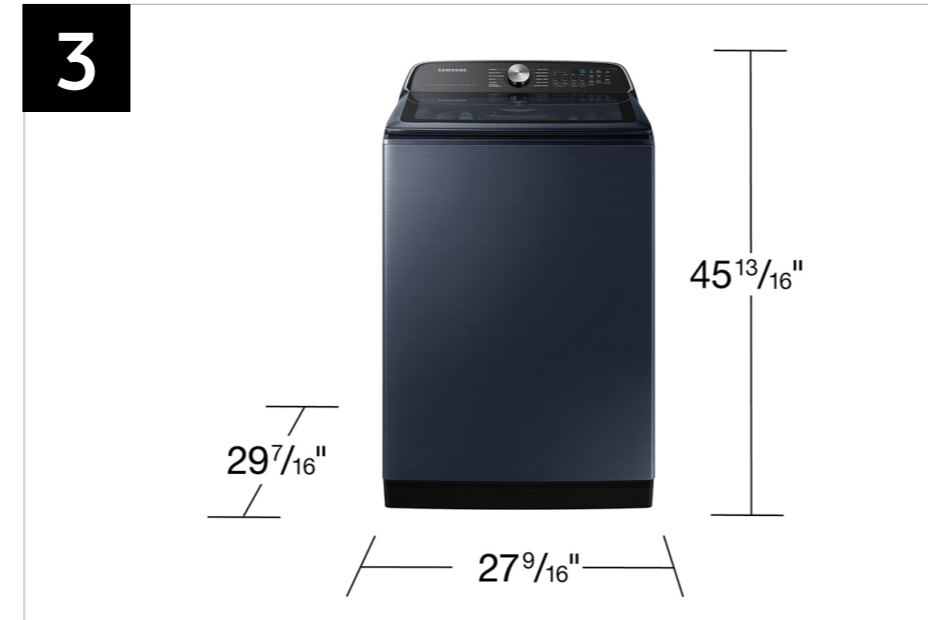

Image provided in decimals and fractions.



Carousel Image Order

WA54CG7150AW



Alternate asset without banner available.

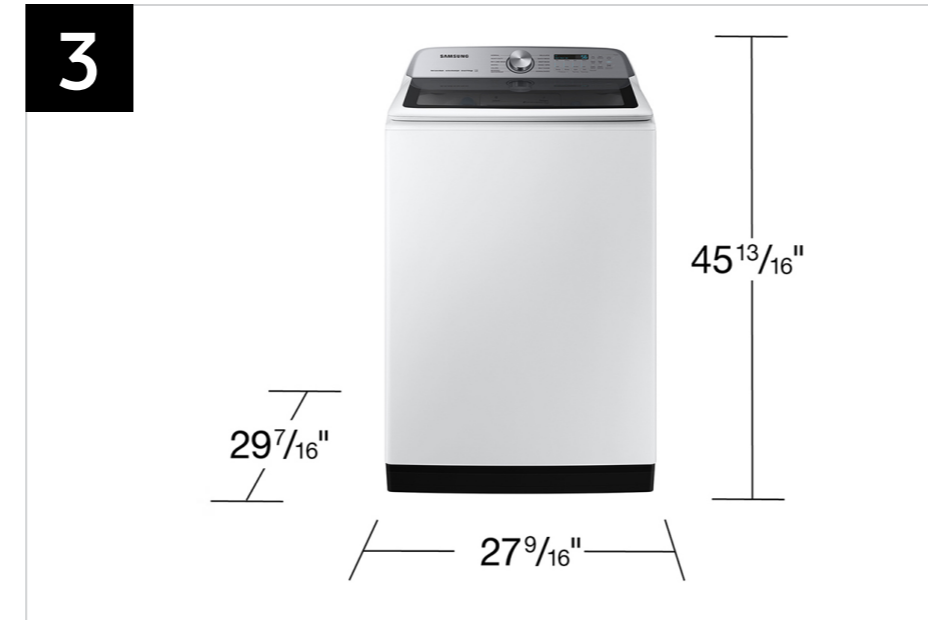

Image provided in decimals and fractions.





Product Messaging



**WA54CG7150AD
WA54CG7150AW**

**5.4 cu. ft. Smart Top Load Washer with Pet Care Solution
and Super Speed Wash**

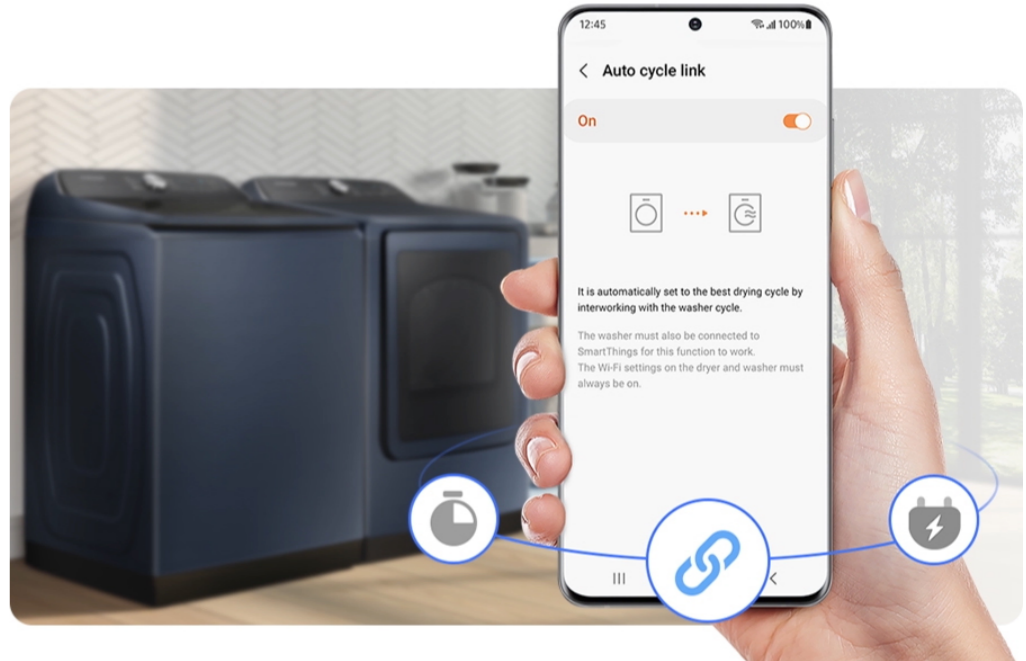

Features and Benefits: WA54CG7150*

Headline	Feature Name	Long Body Copy	Short Body Copy	Associated Image
<p>Remove 6X more pet hair*</p>	<p>Pet Care Solution</p>	<p>Keep your clothes and your pet's bedding clean. Remove 6X more pet hair* with a new Pet Care Wash Cycle that creates dynamic water currents that enable better stain and allergen removal while loosening hair to be trapped by dual pet hair filters.</p> <p><small>*WA7150C using the Pet Care Wash cycle and Pet Hair Filter compared to WA7700A using Normal cycle.</small></p>	<p>Remove 6X more pet hair* with a new Pet Care Wash Cycle that creates dynamic water currents that loosen hair to be trapped by dual pet hair filters.</p> <p><small>*WA7150C using the Pet Care Wash cycle and Pet Hair Filter compared to WA7700A using Normal cycle.</small></p>	
<p>Wash more items in a single load</p>	<p>Extra-Large 5.4 cu. ft. Capacity</p>	<p>Fewer loads, less time in the laundry room, and more time doing the things you love.</p>	<p>Fewer loads, less time in the laundry room.</p>	
<p>Connect with SmartThings</p>	<p>Wi-Fi Connectivity with SmartThings</p>	<p>Wi-Fi connected so you can receive end-of-cycle alerts, remotely start or stop your washing, schedule cycles on your time, and more, right from your smartphone with the SmartThings App.*</p> <p><small>*Requires wireless network, Samsung account and SmartThings App. The Samsung SmartThings App supports Android OS 4.0 (ICS) or later which is optimized for Samsung smartphones (Galaxy S and Galaxy Note series). This app also supports iOS 7 or later for iPhone models. SmartThings App available in App Store and Play Store.</small></p>	<p>With Wi-Fi connectivity, remotely start, stop, or delay your washer from one simple-to-use app. Get energy usage notifications and so much more.*</p> <p><small>*Requires wireless network, Samsung account and SmartThings App. The Samsung SmartThings App supports Android OS 4.0 (ICS) or later which is optimized for Samsung smartphones (Galaxy S and Galaxy Note series). This app also supports iOS 7 or later for iPhone models. SmartThings App available in App Store and Play Store.</small></p>	



Features and Benefits: WA54CG7150* (Continued)

Headline	Feature Name	Long Body Copy	Short Body Copy	Associated Image
<p>Wash a full load in just 28 minutes*</p> <p><small>*Based on using Super Speed on a Normal Cycle with an 8lb load.</small></p>	<p>Super Speed Wash</p>	<p>Wash a full load of laundry in just 28 minutes* without sacrificing cleaning performance.</p> <p><small>*Based on using Super Speed on a Normal Cycle with an 8lb load.</small></p>	<p>Powerful cleaning in just 28 minutes.*</p> <p><small>*Based on using Super Speed on a Normal Cycle with an 8lb load.</small></p>	
<p>Pretreat with a push of a button</p>	<p>Active WaterJet</p>	<p>A built-in water faucet lets you easily pretreat soiled or heavily stained clothes with a press of a button. Scrub items right inside your washer, no laundry room sink needed.</p>	<p>A built-in water faucet lets you easily pretreat heavily soiled and stained clothes.</p>	
<p>Purchase with confidence</p>	<p>20-Year Motor Warranty</p>	<p>Purchase with confidence any Samsung Washer model with a Digital Inverter Motor and receive a 20 year warranty on the motor.*</p> <p><small>*20-year warranty limited to the Digital Inverter Motor of washers purchased on 7/1/2022 or later. Purchase receipt indicating purchase date required for a claim. Additional restrictions and limitations apply, see warranty for details.</small></p>	<p>Purchase with confidence any Samsung Washer model with a Digital Inverter Motor and receive a 20 year warranty on the motor.*</p> <p><small>*20-year warranty limited to the Digital Inverter Motor of washers purchased on 7/1/2022 or later. Purchase receipt indicating purchase date required for a claim. Additional restrictions and limitations apply, see warranty for details.</small></p>	



Features and Benefits: WA54CG7150* (Continued)

Headline	Feature Name	Long Body Copy	Short Body Copy	Associated Image
<p>More water when you need it most</p>	<p>Deep Fill</p>	<p>Selecting the Deep Fill option before starting your laundry maximizes the water level to make sure all your clothes get a thorough soak.*</p> <p><small>*Not available for use in the Bedding/Waterproof and Self Clean courses.</small></p>	<p>Select the Deep Fill option to maximize the water level during the washing cycle.*</p> <p><small>*Not available for use in the Bedding/Waterproof and Self Clean courses.</small></p>	
<p>Quiet washing anytime, any place</p>	<p>Vibration Reduction Technology+</p>	<p>Do your laundry in peace. Our innovative Vibration Reduction Technology+ reduces noise and vibration and creates a quiet washing experience.</p>	<p>Reduces noise and vibration for quiet washing.</p>	
<p>Keep your washer fresh</p>	<p>Self Clean</p>	<p>Keep your washer tub fresh and clean. Self Clean will notify you every 20 wash cycles when it is time for a cleaning.</p>	<p>Keep your washer tub fresh and clean.</p>	

Features and Benefits: WA54CG7150* (Continued)

Headline	Feature Name	Long Body Copy	Short Body Copy	Associated Image
N/A	Soft-Close Lid	The thoughtfully designed Soft-Close Lid closes safely, gently, and quietly.	Soft-Close Lid closes safely, gently, and quietly.	
N/A	Swirl+ Tub Interior	The improved tub pattern draws out more water during the rinse cycle and helps prevent clothes from snagging during the wash.	Improved tub pattern draws out water more quickly and helps prevent snags.	
N/A	ENERGY STAR® Certified	ENERGY STAR® Certified,* so you use less energy without sacrificing performance or functionality.	Eco-friendly and energy-efficient.	

Features and Benefits: WA54CG7150* (Continued)

Headline	Feature Name	Long Body Copy	Short Body Copy	Associated Image
<p>Easy troubleshooting</p>	<p>Smart Care</p>	<p>Easy troubleshooting from the convenience of your smartphone.* Smart Care interacts with your washer and dryer to perform an immediate diagnosis and offer quick solutions.</p> <p><small>*Requires Samsung Smart Washer/Dryer App. The Samsung Smart Washer/Dryer App supports Android OS 2.3.6 or later and iOS 3 or later for iPhone models. Samsung Smart Washer/Dryer App available in App Store and Play Store.</small></p>	<p>Easy troubleshooting from the convenience of your smartphone.*</p> <p><small>*Requires Samsung Smart Washer/Dryer App. The Samsung Smart Washer/Dryer App supports Android OS 2.3.6 or later and iOS 3 or later for iPhone models. Samsung Smart Washer/Dryer App available in App Store and Play Store.</small></p>	
<p>Easier use, for everyone</p>	<p>Accessibility (AUI, Braille)</p>	<p>Aiding the visually and hearing impaired, your washer and dryer now feature audio assistance, playing a different sound for each option, and braille right next to key control panel buttons.</p>	<p>Featuring audio assistance and braille, ensuring easy use for everyone.</p>	
<p>Perfect pair</p>	<p>Matching Dryer</p>	<p>Samsung washers and dryers team up to make light work of laundry day.</p>	<p>N/A</p>	

Lifestyle Images

**WA54CG7150AD
WA54CG7150AW**

**5.4 cu. ft. Smart Top Load Washer with Pet Care Solution
and Super Speed Wash**

Primary Lifestyle Images



Additional Lifestyle Images



Product Specs

**WA54CG7150AD
WA54CG7150AW**

**5.4 cu. ft. Smart Top Load Washer with Pet Care Solution
and Super Speed Wash**

Related Products

Dryer Series	Type	Color
DVE54CG7150D	Electric Dryer	Brushed Navy
DVE54CG7150W	Electric Dryer	White
DVG54CG7150D	Gas Dryer	Brushed Navy
DVG54CG7150W	Gas Dryer	White

Spec Sheet

WA54CG7150 SAMSUNG

Samsung 5.4 cu. ft. Smart Top Load Washer with Pet Care Solution and Super Speed Wash



Available Colors

- Brushed Navy**
WA54CG7150AD
- White**
WA54CG7150AW

Features

- Pet Care Solution
- 5.4 cu. ft. Extra-Large Capacity
- Wi-Fi Connectivity with SmartThings*
- Super Speed Wash
- Active WaterJet
- 20-Year Motor Warranty
- Deep Fill
- Vibration Reduction Technology+
- Swirl+ Tub Interior
- Self Clean
- Soft-Close Lid
- ENERGY STAR® Certified
- Smart Care
- Accessibility (AUI, Braille)
- 750 RPM Maximum Spin Speed
- Digital Inverter Motor
- 17 Total Washing Cycles
- 10 Additional Washing Options

Specifications

- 12 Preset Washing Cycles:** Normal, Bedding/Waterproof, Heavy Duty, Colors, Whites, Delicates, Quick Wash, Self Clean, Rinse + Spin, Deep Wash, Pet Care Wash, Downloaded
- 5 Downloadable Washing Cycles:** Permanent Press, Wool, Eco Cold, Denim, Power Rinse
- 10 Additional Washing Options:** Delay End, Presoak, Sound Off, Child Lock, Fabric Softener, Deep Fill, Super Speed, Smart Care, Smart Control, Spin Only
- 5 Temperature Settings:** Hot, Warmer, Warm, Cool, Cold

- 5 Spin Settings:** High, Medium High, Medium, Low, No Spin
- 5 Soil Settings:** Heavy, Heavy Medium, Normal, Low Medium, Light

- Warranty**
One (1) Year Parts and Labor
Three (3) Years Stainless Steel Tub (Part Only)
Twenty (20) Years Washing DIT (Digital Inverter Motor) Motor Part (Part Only)
Five (5) Years Washing Motor Part (Part Only)

Product Dimensions & Weight (WxHxD)
 Dimensions: 27^{1/8}" x 45^{13/16}" x 29^{7/16}"
 Weight: 134.5 lbs

Shipping Dimensions & Weight (WxHxD)
 Dimensions: 30^{1/8}" x 47^{1/16}" x 31^{1/4}"
 Weight: 143.3 lbs

Washer	Model #	UPC Code
Brushed Navy	WA54CG7150AD	887276760360
White	WA54CG7150AW	887276760377

Matching Electric Dryer	Model #	UPC Code
Brushed Navy	DVE54CG7150D	887276759890
White	DVE54CG7150W	887276759906

Matching Gas Dryer	Model #	UPC Code
Brushed Navy	DVG54CG7150D	887276759937
White	DVG54CG7150W	887276759944

Convenience

- Child Lock
- Dispenser Trays: Main Wash, Softener, Bleach

Ratings

- ENERGY STAR® Rated:
- ENEC = 2.3
- IWF = 3.8
- 120 kWh/yr

Electrical Requirements

- 120 V / 60 Hz
- 15 Amps

*Requires wireless network, Samsung account and Samsung SmartThings App. The Samsung SmartThings App supports Android OS 4.0 (ICS) or later which is optimized for Samsung smartphones (Galaxy S and Galaxy Note series). This app also supports iOS 7 or later for iPhone models. Samsung SmartThings App available in App Store and Play Store.

WA54CG7150 SAMSUNG

Samsung 5.4 cu. ft. Smart Top Load Washer with Pet Care Solution and Super Speed Wash

Dimensions

Required dimensions for installation:

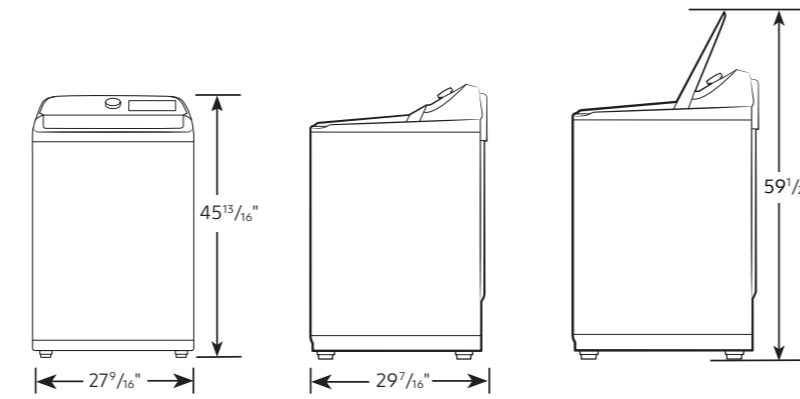

Installation Specifications – Side-by-Side

If the washer and dryer are installed together or the dryer alone, the closet front must have two unobstructed air openings for a combined minimum total area of 72-inch². Your washer alone does not require a specific air opening.

Alcove or closet installation
 Minimum clearance for
 closet and alcove installations:

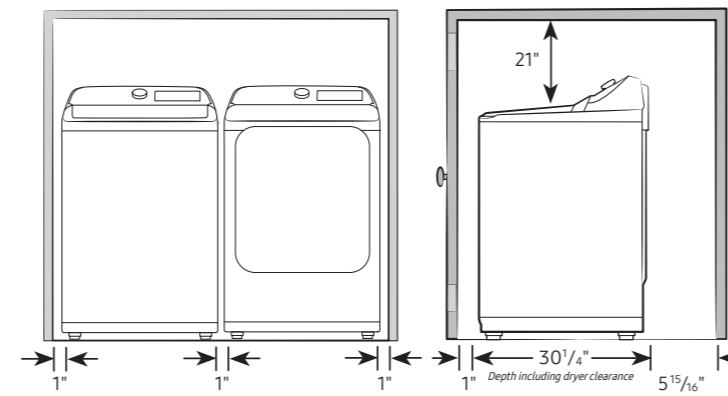

Connection Dimensions

Back view of washer

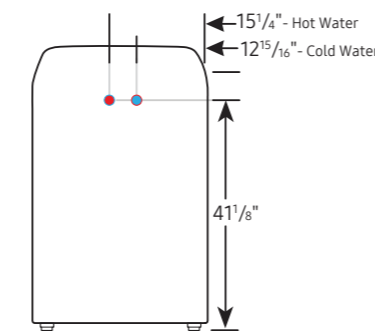

LEGEND:
● Hot Water Connection
● Cold Water Connection

Actual color may vary. Design, specifications, and color availability are subject to change without notice. Non-metric weights and measurements are approximate.

©2020 Samsung Electronics America, Inc. 85 Challenger Road, Ridgefield Park, NJ 07660. Tel: 800-368-5769. samsung.com. Samsung is a registered trademark of Samsung Electronics Co., Ltd.

Energy Guide

U.S. Government Federal law prohibits removal of this label before consumer purchase.

ENERGYGUIDE

Clothes Washer Capacity Class: Standard Samsung Models WA54CG755*A* WA54CG715*A* Capacity (tub volume): 5.4 cubic feet

Compare ONLY to other labels with yellow numbers.
Labels with yellow numbers are based on the same test procedures.

Estimated Yearly Energy Cost
(when used with an electric water heater)

\$17

\$4 Cost Range of Similar Models \$48

120 kWh
Estimated Yearly Electricity Use

\$10
Estimated Yearly Energy Cost
(when used with a natural gas water heater)

- Your cost will depend on your utility rates and use.
- Cost range based only on standard capacity models.
- Estimated energy cost based on six wash loads a week and a national average electricity cost of 14 cents per kWh and natural gas cost of \$1.21 per therm.

ftc.gov/energy



Energy Guide

User Manual and Warranty

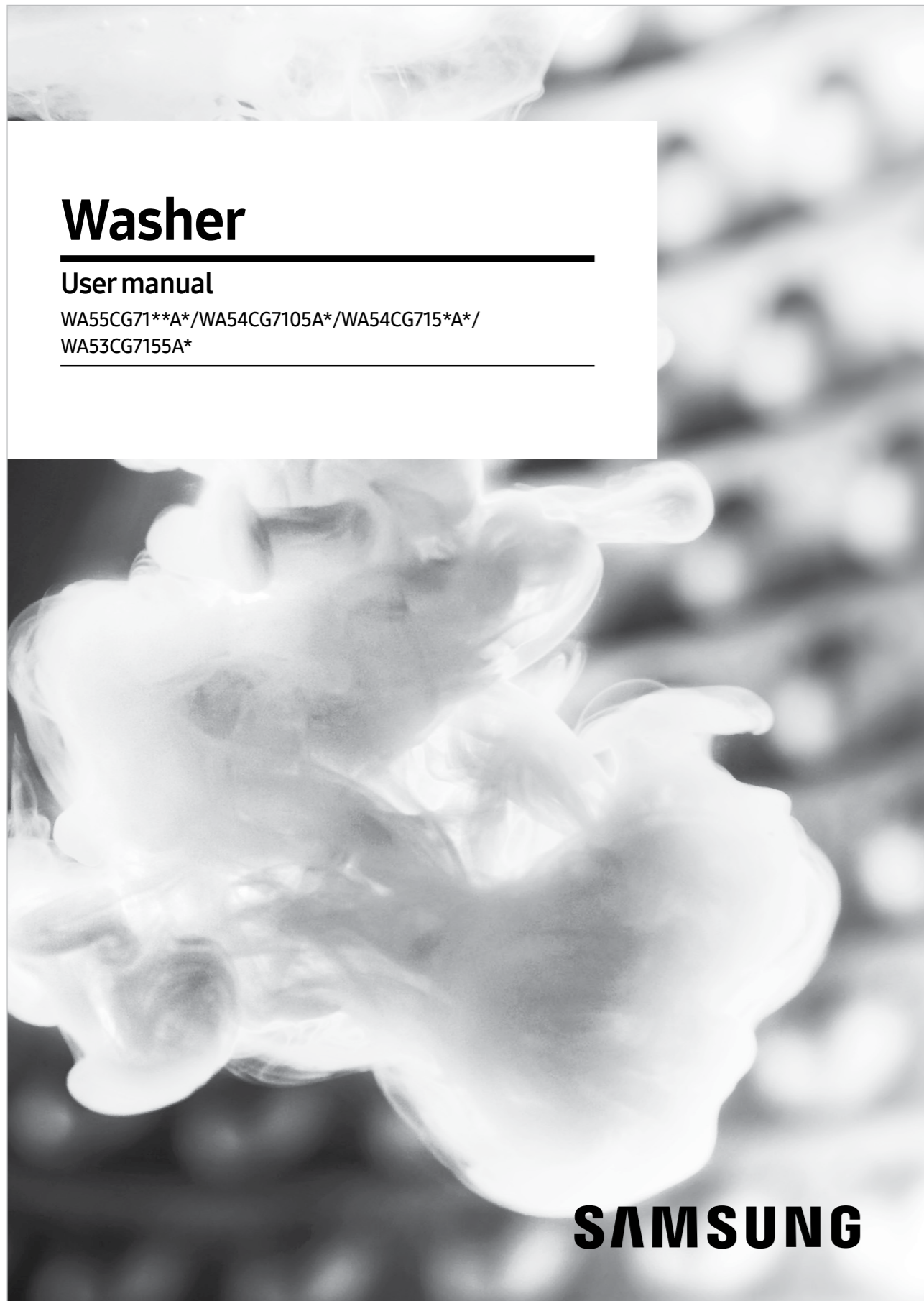

User Manual

LIMITED WARRANTY (U.S.A.) – SAMSUNG TOP LOAD WASHER

Models:
WA54CG7150AW
WA54CG7150AD

LIMITED WARRANTY TO ORIGINAL PURCHASER WITH PROOF OF PURCHASE

This SAMSUNG brand product, as supplied and distributed by SAMSUNG ELECTRONICS AMERICA, INC. (SAMSUNG) and delivered new, in the original carton to the original consumer purchaser, is warranted by SAMSUNG against manufacturing defects in materials or workmanship for the limited warranty period, starting from the date of original purchase, of:

One (1) year Parts and labor
Three (3) years Stainless tub part (Part Only)
Twenty (20) years; Washing DIT (Digital Inverter Motor) motor part (Part Only)
Five (5) years Washing AC motor part (Part Only)

This limited warranty is valid only on products purchased and used in the United States that have been installed, operated, and maintained according to the instructions attached to or furnished with the product. To receive warranty service, the purchaser must contact SAMSUNG at the address or phone number provided below for problem determination and service procedures. Warranty service can only be performed by a SAMSUNG authorized service center. The original dated bill of sale must be presented upon request as proof of purchase to SAMSUNG or SAMSUNG's authorized service center to receive warranty service.

SAMSUNG will provide in-home service within the contiguous United States during the warranty period at no charge, subject to availability of SAMSUNG authorized servicers within the customer's geographic area. If in-home service is not available, SAMSUNG may elect, at its option, to provide transportation of the product to and from an authorized service center. If the product is located in an area where service by a SAMSUNG authorized servicer is not available, you may be responsible for a trip charge or require to bring the product to a SAMSUNG authorized service center for service.

To receive in-home service, product must be unobstructed and accessible to the service agent.

During the applicable warranty period, a product will be repaired, replaced, or the purchase price refunded, at the sole option of SAMSUNG. SAMSUNG may use new or reconditioned parts in repairing a product, or replace the product with a new or reconditioned product. Replacement parts and products are warranted for the remaining portion of the original product's warranty or ninety (90) days, whichever is longer. All replaced parts and products are the property of SAMSUNG and you must return them to SAMSUNG.

This limited warranty covers manufacturing defects in materials or workmanship encountered in normal household, noncommercial use of this product and shall not cover the following: damage that occurs in shipment, delivery, installation, and uses for which this product was not intended; damage caused by unauthorized modification or alteration of the product; product where the original factory serial numbers have been removed, defaced, changed in any way, or cannot be readily determined; cosmetic

Warranty

Feature Icons

**WA54CG7150AD
WA54CG7150AW**

**5.4 cu. ft. Smart Top Load Washer with Pet Care Solution
and Super Speed Wash**

Feature Icons



Pet Care Solution

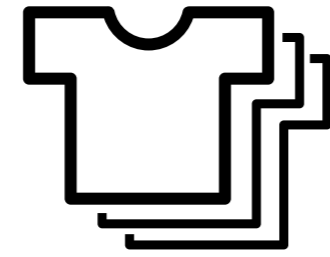

Extra-Large
5.4 cu. ft. Capacity

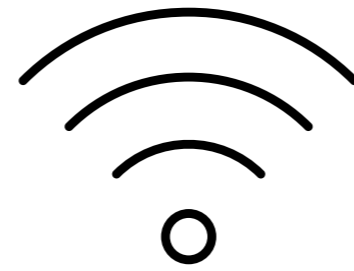

Wi-Fi Connectivity
with SmartThings



Super Speed Wash



Active WaterJet



20-Year Motor
Warranty*

*20-year warranty limited to the Digital Inverter Motor of washers purchased on 7/1/2022 or later. Purchase receipt indicating purchase date required for a claim. Additional restrictions and limitations apply, see warranty for details.

Product Overview

DVE54CG7150D / DVG54CG7150D
DVE54CG7150W / DVG54CG7150W

7.4 cu. ft. Smart Electric Dryer with Pet Care Dry and Steam Sanitize+
7.4 cu. ft. Smart Gas Dryer with Pet Care Dry and Steam Sanitize+

Product Overview

Product Titles

DVE54CG7150 - 7.4 cu. ft. Smart Electric Dryer with Pet Care Dry and Steam Sanitize+

DVG54CG7150 - 7.4 cu. ft. Smart Gas Dryer with Pet Care Dry and Steam Sanitize+

Electric Dryer Description

Samsung's Large Capacity Smart Electric Dryer is equipped with Pet Care Dry Cycle helps remove 97% of 3 unpleasant pet odors.¹ With Steam Sanitize+, which removes 95% of pollen² from fabric, while Multi-Steam refreshes clothing and relaxes light wrinkles. With Wi-Fi connectivity, you can remotely start, stop, or delay your dryer from our simple-to-use SmartThings App.³

Gas Dryer Description

Samsung's Large Capacity Smart Gas Dryer is equipped with Pet Care Dry Cycle helps remove 97% of 3 unpleasant pet odors.¹ With Steam Sanitize+, which removes 95% of pollen² from fabric, while Multi-Steam refreshes clothing and relaxes light wrinkles. With Wi-Fi connectivity, allows you to remotely receive end-of-cycle alerts and more, right from our simple-to-use SmartThings App.³

Electric & Gas Dryer Bullets

- Pet Care Dry - Helps remove 97% of 3 unpleasant odors¹ caused by pets
- Steam Sanitize+ – Sanitize clothing² and reduce wrinkles and odors
- Wi-Fi Connectivity with SmartThings – Remotely start, schedule and receive end of cycle alerts to your smartphone³
- Sensor Dry – Helps prevent overdrying for optimal fabric care

¹ Based on DOE 1.5kg load of wet laundry polluted with 3 gases: Isovaleraldehyde (food), Methyl Mercaptan (feces) and Nonanal (body).

² Testing based on Samsung internal protocols. Results provided to and interpreted by Intertek. Individual results may vary.

³ Requires wireless network, Samsung account and SmartThings App. The Samsung SmartThings App supports Android OS 4.0 (ICS) or later which is optimized for Samsung smartphones (Galaxy S and Galaxy Note series). This app also supports iOS 7 or later for iPhone models. SmartThings App available in App Store and Play Store. Only monitoring enabled on gas dryers for safety reasons.

Easy Ads Links

Brushed Navy Electric and Gas Dryer: https://dam.gettyimages.com/p/z0c3461/digital-appliances?o=AND&q=DV*54CG7150D

White Electric and Gas Dryer: https://dam.gettyimages.com/p/z0c3461/digital-appliances?o=AND&q=DV*54CG7150W

Available Colors

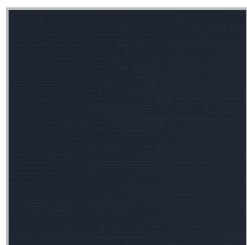

Brushed Navy

Electric Dryer Model Number: DVE54CG7150D
 Electric Dryer UPC: 887276759890
 Gas Dryer Model Number: DVG54CG7150D
 Gas Dryer UPC: 887276759937



White

Electric Dryer Model Number: DVE54CG7150W
 Electric Dryer UPC: 887276759906
 Gas Dryer Model Number: DVG54CG7150W
 Gas Dryer UPC: 887276759944



Carousel Image Order

DVE54CG7150D / DVG54CG7150D



Alternate asset without banner available.

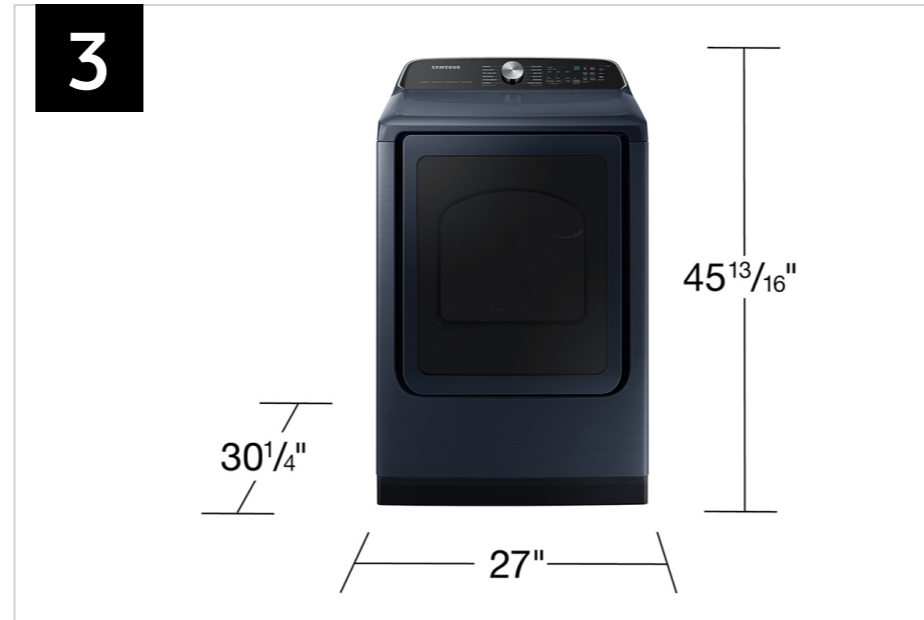

Image provided in decimals and fractions.



Carousel Image Order

DVE54CG7150W / DVG54CG7150W



Alternate asset without banner available.

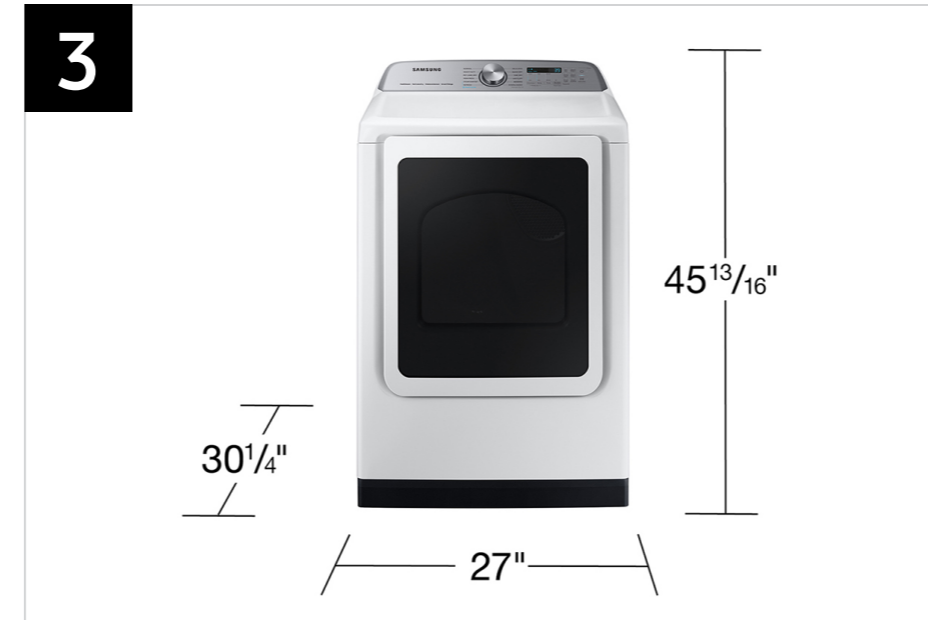

Image provided in decimals and fractions.





Product Messaging



DVE54CG7150D / DVG54CG7150D
DVE54CG7150W / DVG54CG7150W

7.4 cu. ft. Smart Electric Dryer with Pet Care Dry and Steam Sanitize+
7.4 cu. ft. Smart Gas Dryer with Pet Care Dry and Steam Sanitize+

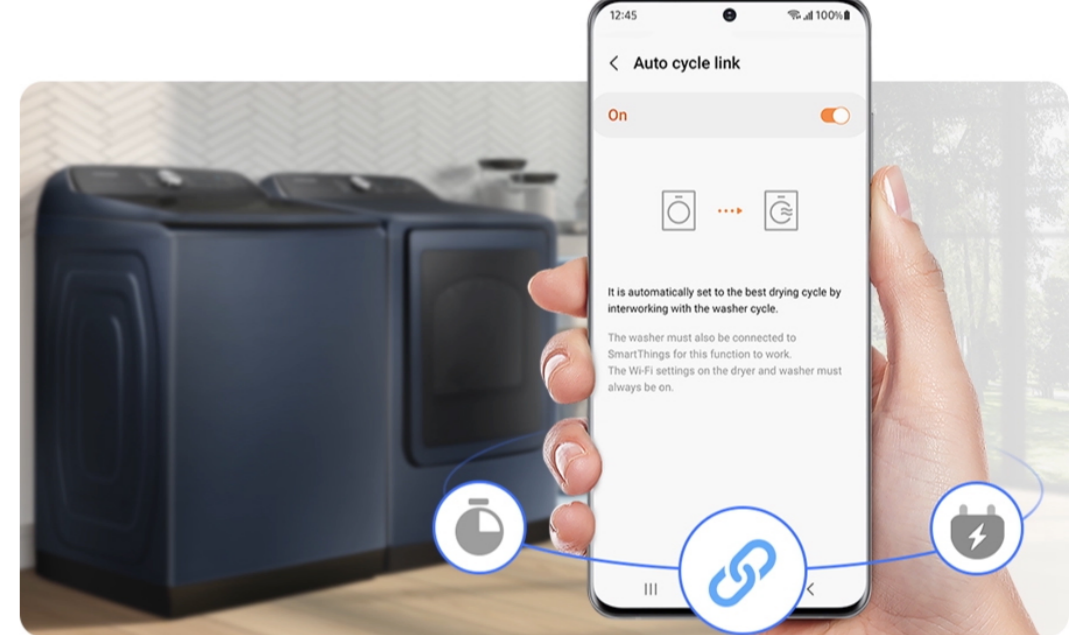

Features and Benefits: DVE(G)54CG7150*

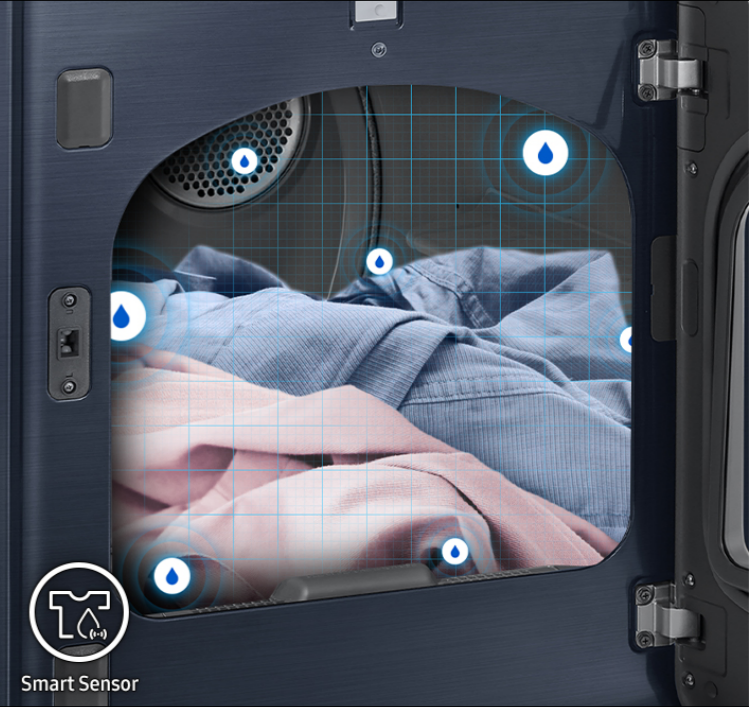
Headline	Feature Name	Long Body Copy	Short Body Copy	Associated Image
<p>Remove stubborn pet odor</p>	<p>Pet Care Dry</p>	<p>Keep your laundry smelling fresh, even with pets around. The Pet Care Dry Cycle helps remove 97% of 3 unpleasant odors* caused by animal food, messes and body odor.</p> <p><small>*Based on DOE 1.5kg load of wet laundry polluted with 3 gases: Isovaleraldehyde (food), Methyl Mercaptan (feces) and Nonanal (body).</small></p>	<p>The Pet Care Dry Cycle helps remove 97% of 3 unpleasant odors* caused by animal food, messes and body odor.</p> <p><small>*Based on DOE 1.5kg load of wet laundry polluted with 3 gases: Isovaleraldehyde (food), Methyl Mercaptan (feces) and Nonanal (body).</small></p>	
<p>Freshen up clothes</p>	<p>Steam Sanitize+</p>	<p>Our Steam Sanitize+ cycle removes 95% of pollen* from fabric, while Multi-Steam refreshes clothing and relaxes light wrinkles.</p> <p><small>*Testing based on Samsung internal protocols. Results provided to and interpreted by Intertek. Individual results may vary.</small></p>	<p>Removes 95% of pollen from fabric,* relaxes light wrinkles, and refreshes clothing.</p> <p><small>*Testing based on Samsung internal protocols. Results provided to and interpreted by Intertek. Individual results may vary.</small></p>	
<p>Connect with SmartThings</p>	<p>Wi-Fi Connectivity with SmartThings</p>	<p>With Wi-Fi connectivity, remotely start, stop, or delay your dryer from one simple-to-use app. Get cycle recommendations, alerts when your drying is done, energy usage notifications and so much more.*</p> <p><small>*Requires wireless network, Samsung account and SmartThings App. The Samsung SmartThings App supports Android OS 4.0 (ICS) or later which is optimized for Samsung smartphones (Galaxy S and Galaxy Note series). This app also supports iOS 7 or later for iPhone models. SmartThings App available in App Store and Play Store.</small></p>	<p>With Wi-Fi connectivity, remotely start, stop, or delay your dryer from one simple-to-use app. Get energy usage notifications and so much more.*</p> <p><small>*Requires wireless network, Samsung account and SmartThings App. The Samsung SmartThings App supports Android OS 4.0 (ICS) or later which is optimized for Samsung smartphones (Galaxy S and Galaxy Note series). This app also supports iOS 7 or later for iPhone models. SmartThings App available in App Store and Play Store.</small></p>	



Features and Benefits: DVE(G)54CG7150* (Continued)

Headline	Feature Name	Long Body Copy	Short Body Copy	Associated Image
<p>Worry-free drying</p>	<p>Sensor Dry</p>	<p>Automatically optimizes the time and temperature of your drying cycle to protect your clothes from heat damage, while avoiding excess energy use.</p>	<p>Helps prevent overdrying for optimal fabric care.</p>	 <p>The image shows the interior of a dryer with clothes inside. A grid of blue sensor lights is overlaid on the clothes, and a 'Smart Sensor' icon is visible in the bottom left corner.</p>
<p>Easy troubleshooting</p>	<p>Smart Care</p>	<p>Easy troubleshooting from the convenience of your smartphone.* Smart Care interacts with your washer and dryer to perform an immediate diagnosis and offer quick solutions.</p> <p><small>*Requires Samsung Smart Washer/Dryer App. The Samsung Smart Washer/Dryer App supports Android OS 2.3.6 or later and iOS 3 or later for iPhone models. Samsung Smart Washer/Dryer App available in App Store and Play Store.</small></p>	<p>Easy troubleshooting from the convenience of your smartphone.*</p> <p><small>*Requires Samsung Smart Washer/Dryer App. The Samsung Smart Washer/Dryer App supports Android OS 2.3.6 or later and iOS 3 or later for iPhone models. Samsung Smart Washer/Dryer App available in App Store and Play Store.</small></p>	 <p>The image shows a person's hands holding a smartphone in front of a Samsung Smart Washer and Dryer. The phone screen displays the Samsung Smart Washer app interface, which includes a 'Recognize Smart Care' section and a 'Smart Care' button.</p>
<p>Put an end to stray socks</p>	<p>Internal Drum Light</p>	<p>An internal drum light lets you see the contents of your dryer more clearly, meaning fewer missed socks or small items.</p>	<p>An internal drum light lets you see the contents of your dryer more clearly.</p>	 <p>The image shows the interior of a dryer with the door open. A bright light is visible inside the drum, illuminating a pile of clothes.</p>

Features and Benefits: DVE(G)54CG7150* (Continued)

Headline	Feature Name	Long Body Copy	Short Body Copy	Associated Image
<p>Flexible opening</p>	<p>Reversible Dryer Door</p>	<p>Choose which way your dryer door opens to better suit your laundry room layout.</p>	<p>Choose which way your dryer door opens.</p>	
<p>Easier use, for everyone</p>	<p>Accessibility (AUI, Braille)</p>	<p>Aiding the visually and hearing impaired, your washer and dryer now feature audio assistance, playing a different sound for each option, and braille right next to key control panel buttons.</p>	<p>Featuring audio assistance and braille, ensuring easy use for everyone.</p>	
<p>Dry more items in a single load</p>	<p>Large 7.4 cu. ft. Capacity</p>	<p>Fewer loads, less time in the laundry room, and more time doing the things you love.</p>	<p>Fewer loads, less time in the laundry room.</p>	

Features and Benefits: DVE(G)54CG7150* (Continued)

Headline	Feature Name	Long Body Copy	Short Body Copy	Associated Image
<p>Stop the fluff</p>	<p>Lint Filter Indicator</p>	<p>Worry less about lint or fluff blocking the dryer's air intake. The control panel provides a helpful reminder to clean the filter to keep your dryer running smoothly.</p>	<p>The control panel lets you know when it's time to clean the filter.</p>	
<p>Perfect pair</p>	<p>Matching Washer</p>	<p>Samsung washers and dryers team up to make light work of laundry day.</p>	<p>N/A</p>	

Product Specs

DVE54CG7150D / DVG54CG7150D
DVE54CG7150W / DVG54CG7150W

7.4 cu. ft. Smart Electric Dryer with Pet Care Dry and Steam Sanitize+
7.4 cu. ft. Smart Gas Dryer with Pet Care Dry and Steam Sanitize+

Related Products and Accessories

Impeller Version	Type	Color
WA54CG7150AD	Top Load Washer	Brushed Navy
WA54CG7150AW	Top Load Washer	White

Gas Dryer Conversion Kit	Dryer Vent Kit
LPKIT-4	DV-2A

Spec Sheets

DVE54CG7150

Samsung 7.4 cu. ft. Smart Electric Dryer with Pet Care Dry and Steam Sanitize+



SAMSUNG

Available Colors

- Brushed Navy
DVE54CG7150D
- White
DVE54CG7150W

Features

- Pet Care Dry
- Steam Sanitize+
- Wi-Fi Connectivity with SmartThings*
- Sensor Dry
- Smart Care**
- Interior Drum Light
- Reversible Door
- Accessibility (AUI, Braille)
- Large 7.4 cu. ft. Capacity
- Lint Filter Indicator
- 21 Total Drying Cycles
- 10 Options
- 5 Temperature Settings
- 4-Way Venting (Back, Bottom, Left, Right)

Convenience

- Child Lock
- Lint Filter Indicator

Rating

644 kWh/yrw

Electrical Requirements

240 V / 60 Hz
30 Amps

Specifications

12 Preset Drying Cycles:
Refresh, Steam Sanitize+, Normal, Heavy Duty, Permanent Press, Bedding, Delicates, Pet Care Dry, Time Dry, Air Fluff, Quick Dry, Downloaded

5 Dry Levels:
More Dry, Normal-More Dry, Normal Dry, Normal-Less Dry, Less Dry

9 Downloadable Drying Cycles:
Wrinkle Away, Eco Normal, Towels, Wool, Sanitize, Shirts, Denim, Low Temp, Rack Dry

10 Options:
Damp Alert, Wrinkle Prevent, Adjust Time (Up), Adjust Time (Down), Child Lock, Sound On/Off, Eco Dry, Smart Care, Drum Light, Smart Control

5 Temperature Settings:
High, Medium High, Medium, Medium Low, Low

Warranty
One (1) Year Parts and Labor

Product Dimensions & Weight (WxHxD)
Dimensions: 27" x 45¹³/₁₆" x 30¹/₄"
Weight: 119.0 lbs

Shipping Dimensions & Weight (WxHxD)
Dimensions: 29¹/₂" x 48⁷/₈" x 31¹/₁₆"
Weight: 127.9 lbs

Electric Dryer	Model #	UPC Code
Brushed Navy	DVE54CG7150D	887276759890
White	DVE54CG7150W	887276759906

Gas Dryer	Model #	UPC Code
Brushed Navy	DVG54CG7150D	887276759937
White	DVG54CG7150W	887276759944

Matching Washer	Model #	UPC Code
Brushed Navy	WA54CG7150AD	887276760360
White	WA54CG7150AW	887276760377

Optional Accessories	Model #	UPC Code
Vent Kit	DV-2A	887276146416

*Requires wireless network, Samsung account and Samsung SmartThings App. The Samsung SmartThings App supports Android OS 4.0 (ICS) or later which is optimized for Samsung smartphones (Galaxy S and Galaxy Note series). This app also supports iOS 7 or later for iPhone models. Samsung SmartThings App available in App Store and Play Store. Only monitoring enabled on Gas Dryers for safety reasons.

**Requires Samsung Smart Washer/Dryer App. The Samsung Smart Washer/Dryer App supports Android OS 2.3.6 or later and iOS 3 or later for iPhone models. Samsung Smart Washer/Dryer App available in App Store and Play Store.

Electric Dryer Spec Sheet - page 1

DVE54CG7150

Samsung 7.4 cu. ft. Smart Electric Dryer with Pet Care Dry and Steam Sanitize+

SAMSUNG

Dimensions
Required dimensions for installation:

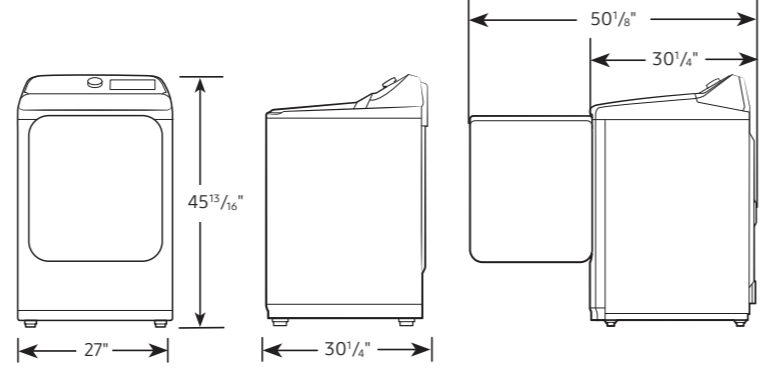

Installation Specifications – Side-by-Side
If the washer and dryer are installed together or the dryer alone, the closet front must have two unobstructed air openings for a combined minimum total area of 72-inch². Your washer alone does not require a specific air opening.

Alcove or closet installation
Minimum clearance for closet and alcove installations:

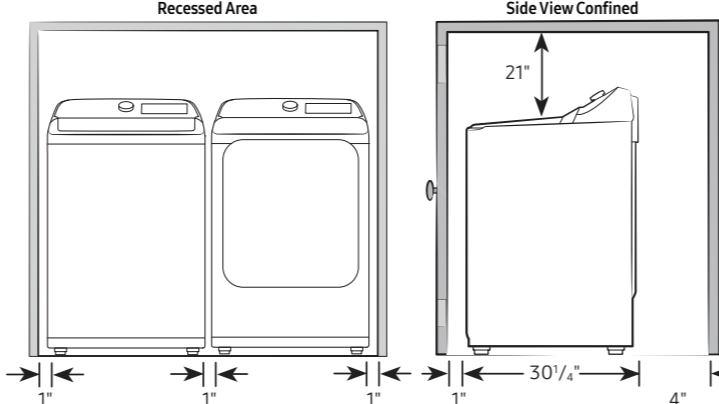

Connection Dimensions
Back and Side View of Electric Dryer

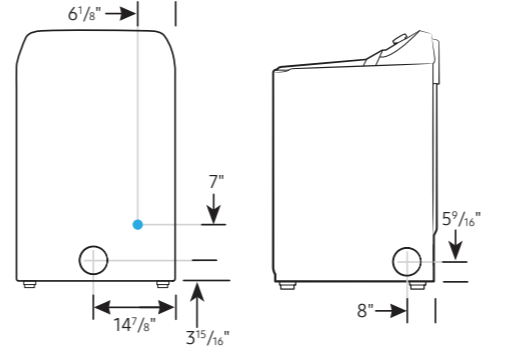

LEGEND:
● Cold Water Connection
● Gas Connection

Actual color may vary. Design, specifications, and color availability are subject to change without notice. Non-metric weights and measurements are approximate.
©2023 Samsung Electronics America, Inc. 85 Challenger Road, Ridgefield Park, NJ 07660. Tel: 800-SAMSUNG, samsung.com. Samsung is a registered trademark of Samsung Electronics Co., Ltd.

Electric Dryer Spec Sheet - page 2

DVG54CG7150

Samsung 7.4 cu. ft. Smart Gas Dryer with Pet Care Dry and Steam Sanitize+



SAMSUNG

Available Colors

- Brushed Navy
DVG54CG7150D
- White
DVG54CG7150W

Features

- Pet Care Dry
- Steam Sanitize+
- Wi-Fi Connectivity with SmartThings*
- Sensor Dry
- Smart Care**
- Interior Drum Light
- Reversible Door
- Accessibility (AUI, Braille)
- Large 7.4 cu. ft. Capacity
- Lint Filter Indicator
- 21 Total Drying Cycles
- 10 Options
- 5 Temperature Settings
- 3-Way Venting (Back, Bottom, Left)

Convenience

- Child Lock
- Lint Filter Indicator

Specifications

12 Preset Drying Cycles:
Refresh, Steam Sanitize+, Normal, Heavy Duty, Permanent Press, Bedding, Delicates, Pet Care Dry, Time Dry, Air Fluff, Quick Dry, Downloaded

9 Downloadable Drying Cycles:
Wrinkle Away, Eco Normal, Towels, Wool, Sanitize, Shirts, Denim, Low Temp, Rack Dry

10 Options:
Damp Alert, Wrinkle Prevent, Adjust Time (Up), Adjust Time (Down), Child Lock, Sound On/Off, Eco Dry, Smart Care, Drum Light, Smart Monitor

5 Temperature Settings:
High, Medium High, Medium, Medium Low, Low

5 Dry Levels:
More Dry, Normal-More Dry, Normal Dry, Normal-Less Dry, Less Dry

Warranty
One (1) Year Parts and Labor

Product Dimensions & Weight (WxHxD)
Dimensions: 27" x 45¹³/₁₆" x 30¹/₄"
Weight: 119.0 lbs

Shipping Dimensions & Weight (WxHxD)
Dimensions: 29¹/₂" x 48⁷/₈" x 31¹/₁₆"
Weight: 127.9 lbs

Gas Dryer	Model #	UPC Code	Optional Accessories	Model #	UPC Code
Brushed Navy	DVG54CG7150D	887276759937	Vent Kit	DV-2A	887276146416
White	DVG54CG7150W	887276759944	Gas-to-Propane Converter Kit	LPKIT-4	887276352787

Electric Dryer	Model #	UPC Code
Brushed Navy	DVE54CG7150D	887276759890
White	DVE54CG7150W	887276759906

Matching Washer	Model #	UPC Code
Brushed Navy	WA54CG7150AD	887276760360
White	WA54CG7150AW	887276760377

*Requires wireless network, Samsung account and Samsung SmartThings App. The Samsung SmartThings App supports Android OS 4.0 (ICS) or later which is optimized for Samsung smartphones (Galaxy S and Galaxy Note series). This app also supports iOS 7 or later for iPhone models. Samsung SmartThings App available in App Store and Play Store. Only monitoring enabled on Gas Dryers for safety reasons.

**Requires Samsung Smart Washer/Dryer App. The Samsung Smart Washer/Dryer App supports Android OS 2.3.6 or later and iOS 3 or later for iPhone models. Samsung Smart Washer/Dryer App available in App Store and Play Store.

Gas Dryer Spec Sheet - page 1

DVG54CG7150

Samsung 7.4 cu. ft. Smart Gas Dryer with Pet Care Dry and Steam Sanitize+

SAMSUNG

Dimensions
Required dimensions for installation:

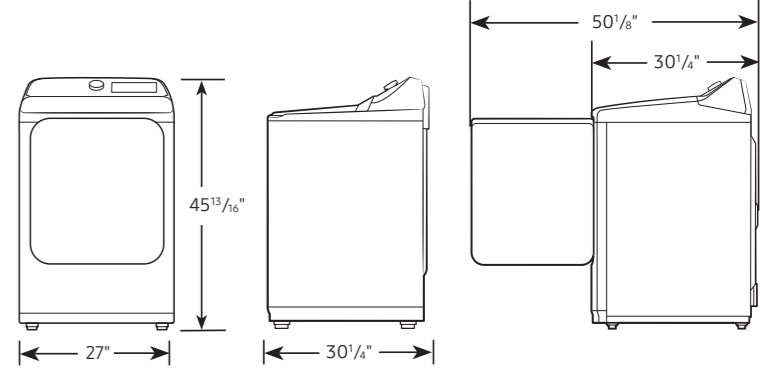

Installation Specifications – Side-by-Side
If the washer and dryer are installed together or the dryer alone, the closet front must have two unobstructed air openings for a combined minimum total area of 72-inch². Your washer alone does not require a specific air opening.

Alcove or closet installation
Minimum clearance for closet and alcove installations:

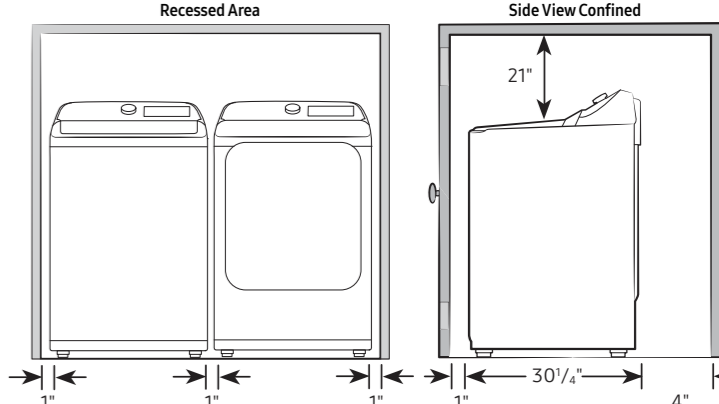

Connection Dimensions
Back and Side View of Gas Dryer

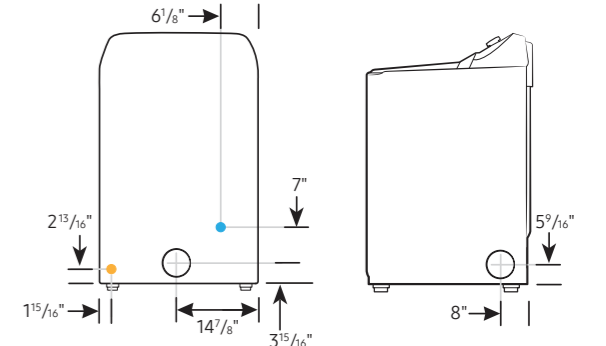

LEGEND:
● Cold Water Connection
● Gas Connection

Actual color may vary. Design, specifications, and color availability are subject to change without notice. Non-metric weights and measurements are approximate.
©2023 Samsung Electronics America, Inc. 85 Challenger Road, Ridgefield Park, NJ 07660. Tel: 800-SAMSUNG, samsung.com. Samsung is a registered trademark of Samsung Electronics Co., Ltd.

Gas Dryer Spec Sheet - page 2

User Manual and Warranty

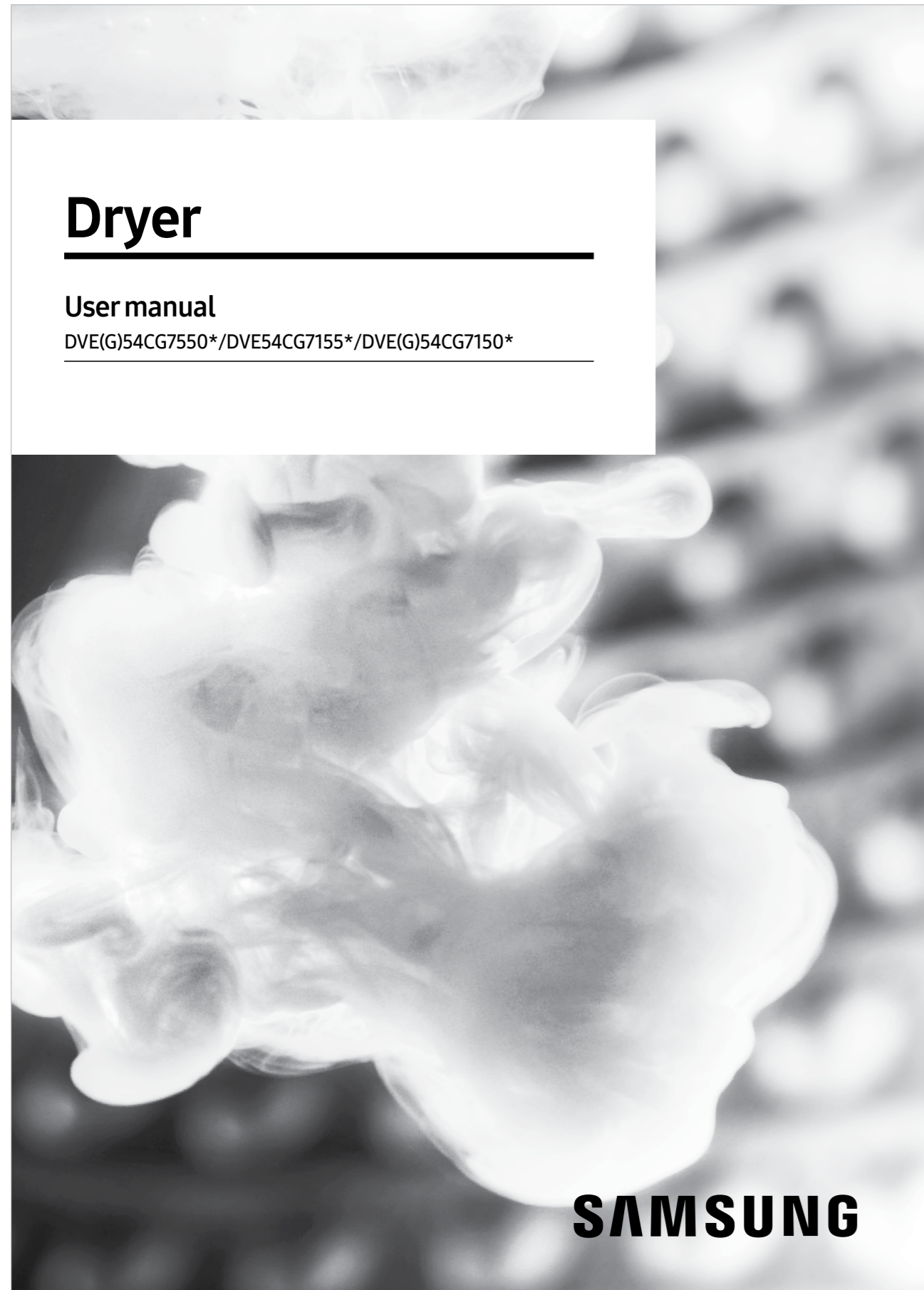

User Manual - Electric and Gas Dryers

LIMITED WARRANTY (U.S.A.) – SAMSUNG DRYER

Models:

DVE(G)54CG7150W
DVE(G)54CG7150D

LIMITED WARRANTY TO ORIGINAL PURCHASER WITH PROOF OF PURCHASE

This SAMSUNG brand product, as supplied and distributed by SAMSUNG ELECTRONICS AMERICA INC. (SAMSUNG) and delivered new, in the original carton to the original consumer purchaser, is warranted by SAMSUNG against manufacturing defects in materials or workmanship for the limited warranty period, starting from the date of original purchase, of:

One (1) Year Parts and Labor

This limited warranty is valid only on products purchased and used in the United States that have been installed, operated, and maintained according to the instructions attached to or furnished with the product. To receive warranty service, the purchaser must contact SAMSUNG at the address or phone number provided below for problem determination and service procedures. Warranty service can only be performed by a SAMSUNG authorized service center. The original dated bill of sale must be presented upon request as proof of purchase to SAMSUNG or SAMSUNG's authorized service center to receive warranty service.

SAMSUNG will provide in-home service within the contiguous United States during the warranty period at no charge, subject to availability of SAMSUNG authorized servicers within the customer's geographic area. If in-home service is not available, SAMSUNG may elect, at its option, to provide transportation of the product to and from an authorized service center. If the product is located in an area where service by a SAMSUNG authorized servicer is not available, you may be responsible for a trip charge or required to bring the product to a SAMSUNG authorized service center for service.

To receive in-home service, product must be unobstructed and accessible to the service agent.

During the applicable warranty period, a product will be repaired, replaced, or the purchase price refunded, at the sole option of SAMSUNG. SAMSUNG may use new or reconditioned parts in repairing a product, or replace the product with a new or reconditioned product. Replacement parts and products are warranted for the remaining portion of the original product's warranty or ninety (90) days, whichever is longer. All replaced parts and products are the property of SAMSUNG and you must return them to SAMSUNG.

Warranty - Electric and Gas Dryers

Feature Icons

DVE54CG7150D / DVG54CG7150D
DVE54CG7150W / DVG54CG7150W

7.4 cu. ft. Smart Electric Dryer with Pet Care Dry and Steam Sanitize+
7.4 cu. ft. Smart Gas Dryer with Pet Care Dry and Steam Sanitize+

Feature Icons



Pet Care Dry

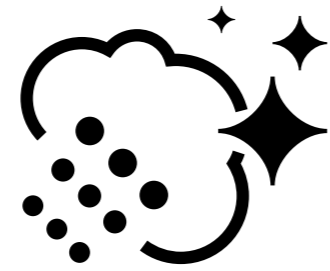

Steam Sanitize+

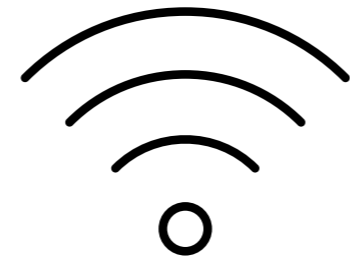

Wi-Fi Connectivity
with SmartThings

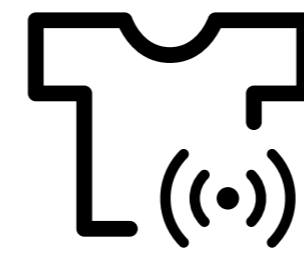

Sensor Dry



Smart Care

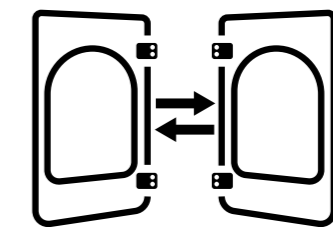

Reversible Dryer Door

Price Tag Guidance

Please follow one of the below naming conventions for price tags at retail, accounting for any potential character count limitations. Please also ensure that any feature list appearing on fact tags follows the Product Messaging hierarchy and copy noted in the Product Guide for each model.

WA54CG7150A*

Long (More than 40 Characters)

5.4 cu. ft. Smart Top Load Washer with Pet Care Solution and Super Speed (72 characters)

Medium (40 Characters or less)

5.4 cu. ft. Top Load Washer w/ Pet Care (39 characters)

Short (30 Characters or less)

5.4 cu. ft. Top Load Washer (27 characters)

DVE55CG7100*

Long (More than 40 Characters)

7.4 cu. ft. Smart Electric Dryer with Pet Care Dry and Steam Sanitize+ (70 characters)

Medium (40 Characters or less)

7.4 cu. ft. Electric Dryer (26 characters)

Short (30 Characters or less)

7.4 cu. ft. Electric Dryer (26 characters)

DVG55CG7100*

Long (More than 40 Characters)

7.4 cu. ft. Smart Gas Dryer with Pet Care Dry and Steam Sanitize+ (65 characters)

Medium (40 Characters or less)

7.4 cu. ft. Gas Dryer (21 characters)

Short (30 Characters or less)

7.4 cu. ft. Gas Dryer (21 characters)

SAMSUNG