



# PARTS LIST / LISTE DES PIÈCES / LISTA DE PIEZAS

ITEM NO. / ARTICLE NO. / ARTICULO NO. : P629100/110

DESCRIPTION / DESCRIPCIÓN : CAMILA DRESSER/ COMMODE/ TOCADOR

CAMILA MIRROR / MIROIR / ESPEJO

## ⚠ WARNING



Children have died from furniture tipover. To reduce the risk of furniture tipover:

- ALWAYS install tipover restraint provided.
- NEVER put a TV on this product.
- NEVER allow children to stand, climb or hang on drawers, doors, or shelves.
- NEVER open more than one drawer at a time.
- Place heaviest items in the lowest drawers.



This is a permanent label. Do not remove!

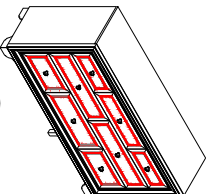
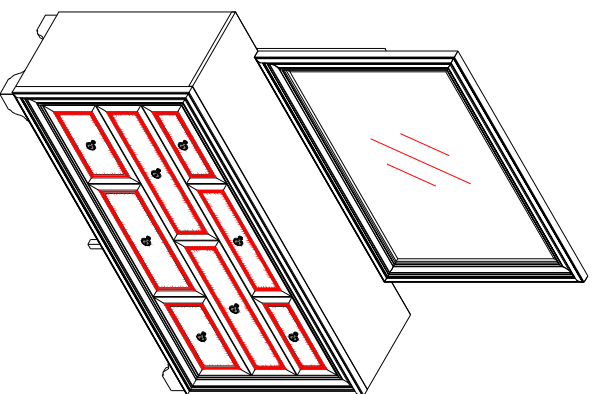

**A**

- x1 Dresser \*
- x1 Commode
- x1 Tocador

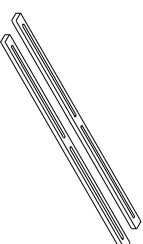

**B**

- x2 Mirror Support \*
- x2 Supporte de miroir
- x2 Soporte del espejo

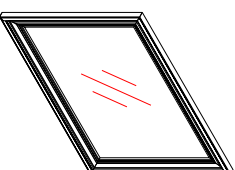

**C**

- x1 Mirror \*
- x1 Miroir
- x1 Espejo



**D**

- x1 Furniture Tipping Restraint \*
- x1 Systeme antibasculement
- x1 Control para evitar vuelcos

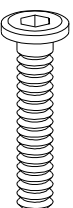

**E**

- x8 Allen bolt  $\phi 1/4 \times 38\text{mm}$  \*
- x8 Vis à tête creuse hexagonale  $\phi 1/4 \times 38\text{mm}$
- x8 Perno Allen  $\phi 1/4 \times 38\text{mm}$



**F**

- x8 Lock washer  $\phi 1/4$  \*
- x8 Rondelle de blocage  $\phi 1/4$
- x8 Arandela de Seguridad  $\phi 1/4$



**G**

- x8 Flat Washer  $\phi 1/4 \times 19 \times 2\text{mm}$  \*
- x8 Rondelle plate  $\phi 1/4 \times 19 \times 2\text{mm}$
- x8 Arandela plana  $\phi 1/4 \times 19 \times 2\text{mm}$

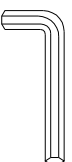

**H**

- x1 Allen Key 4mm \*
- x1 Clé hexagonale 4mm
- x1 Llave Allen 4mm

\* Replaceable Part



## ASSEMBLY INSTRUCTIONS / NOTICE DE MONTAGE / INSTRUCCIONES DE MONTAJE

ITEM NO. / ARTICLE NO. / ARTICULO NO. : P629100/110

DESCRIPTION / DESCRIPCIÓN : CAMILA DRESSER/ COMMODE/ TOCADOR

CAMILA MIRROR / MIROIR / ESPEJO

### ⚠ WARNING



Children have died from furniture tipover. To reduce the risk of furniture tipover:

- ALWAYS install tipover restraint provided.
- NEVER put a TV on this product.
- NEVER allow children to stand, climb or hang on drawers, doors, or shelves.
- NEVER open more than one drawer at a time.
- Place heaviest items in the lowest drawers.



This is a permanent label. Do not remove!

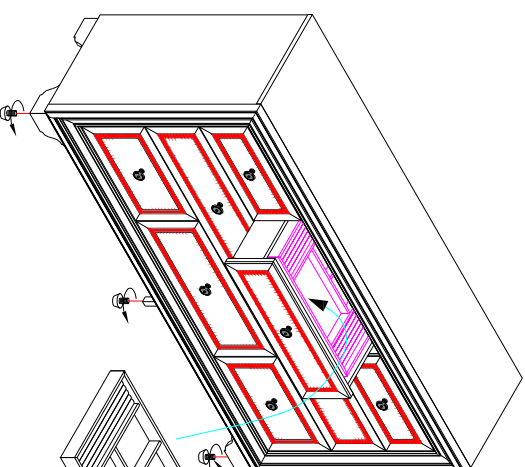
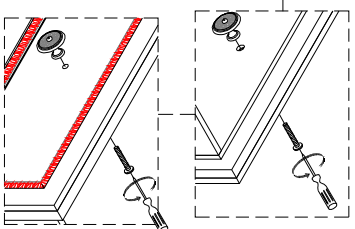
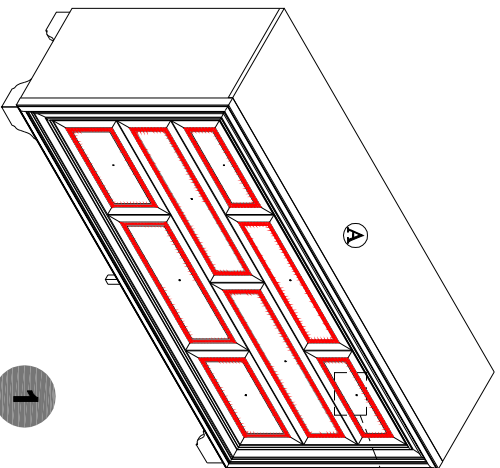

Adjustable leveler (3 pcs)  
Patín réglable (X 3)  
Nivelador ajustable (3 pza)

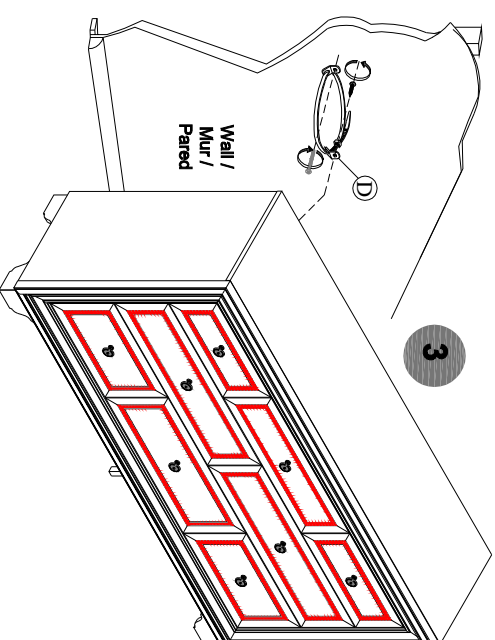

\* Replaceable Part



## ASSEMBLY INSTRUCTIONS / NOTICE DE MONTAGE / INSTRUCCIONES DE MONTAJE

ITEM NO. / ARTICLE NO. / ARTICULO NO. : P629100/110

DESCRIPTION / DESCRIPCIÓN : CAMILA DRESSER / COMMUNE / TOCADOR

CAMILA MIRROR / MIROIR / ESPEJO

### ⚠ WARNING



Children have died from furniture tipover. To reduce the risk of furniture tipover:

- ALWAYS install tipover restraint provided.
- NEVER put a TV on this product.
- NEVER allow children to stand, climb or hang on drawers, doors, or shelves.
- NEVER open more than one drawer at a time.
- Place heaviest items in the lowest drawers.



This is a permanent label. Do not remove!

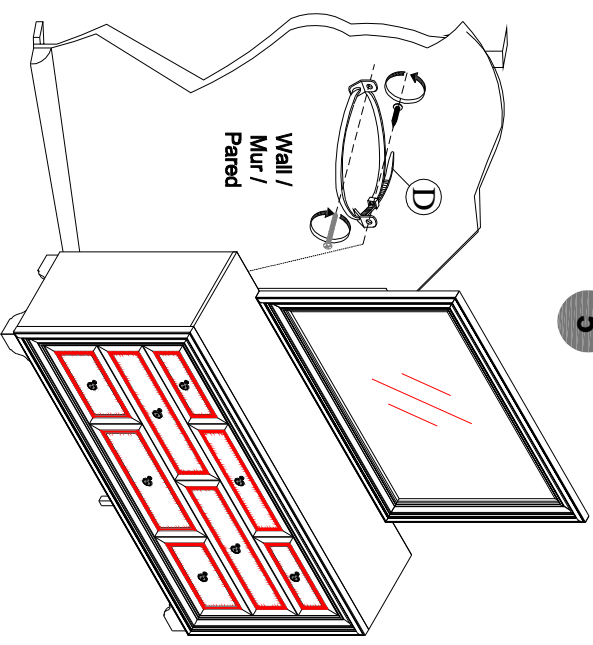
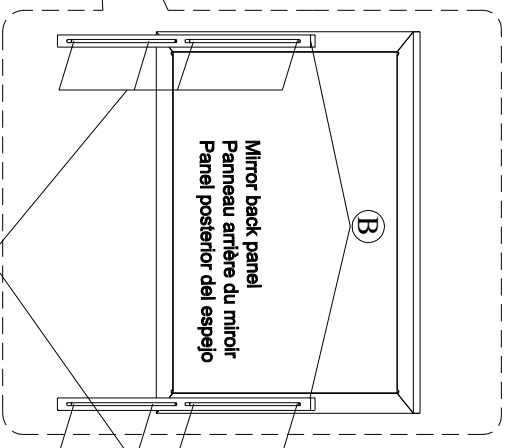
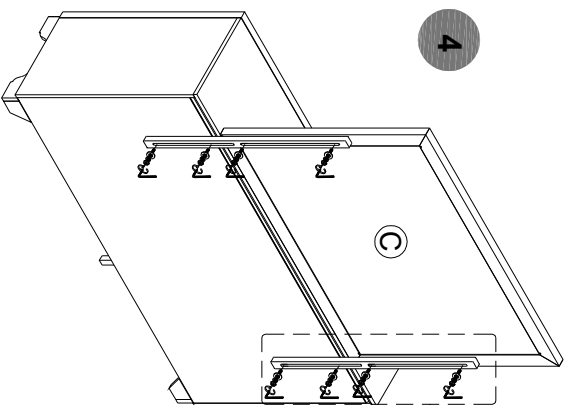

\* Replaceable Part



# REPLACEABLE PART / PARTIE REMPLAÇABLE / PARTE REEMPLAZABLE

ITEM NO. / ARTICLE NO. / ARTICULO NO. : P629100/110

DESCRIPTION / DESCRIPCIÓN : CAMILA DRESSER/ COMMODE/ TOCADOR

CAMILA MIRROR / MIROIR / ESPEJO

<b>⚠ WARNING</b>	
	<p>Children have died from furniture tipover. To reduce the risk of furniture tipover:</p> <ul style="list-style-type: none"> <li>• ALWAYS install tipover restraint provided.</li> <li>• NEVER put a TV on this product.</li> <li>• NEVER allow children to stand, climb or hang on drawers, doors, or shelves.</li> <li>• NEVER open more than one drawer at a time.</li> <li>• Place heaviest items in the lowest drawers.</li> </ul> <p><i>This is a permanent label. Do not remove!</i></p>

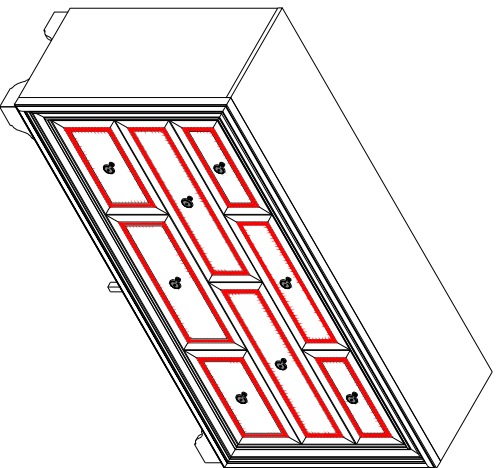

x8 RP269-KNOB-Knob with Screw \*  
Poignée + vis  
Tirador + Tornillo



x8 COMGLIDE-12-45 - Glide 12inch 45mm \*  
Tiroir Glide  
Deslizamiento del cajón

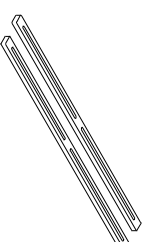

x2 RP629110-MISU-Mirror Support \*  
Supporte de miroir  
Soporte del espejo



x1 RP629110-HWKIT-Hardware kit list \*  
Liste des pièces de quincaillerie  
Lista del kit de materiales



x3 RC-FG-WHITE-White Leveler \*  
Patin réglable  
Nivelador



x2 RC-WH-NAIL - White Plastic Nail - Clavo \*

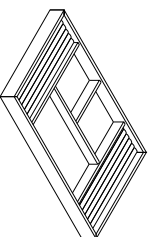

x1 RP269100-TRAY- Jewelry Tray \*  
Plateau à bijoux  
Bandeja de joyas



x1 RC-ANTI-TIP- Anti-tipping Restraint \*  
Système antibascullement  
Control para evitar vaticos

\* Replaceable Part