

SAMSUNG

Product Guide

8000 Series Laundry

Available in Brushed Black and White



Table of Contents

WF51CG8000 - Front Load Washer

Product Overview

Product Overview 4

Carousel Image Order 5

Product Messaging

Features and Benefits 8

Product Specs

Related Products and Accessories 13

Spec Sheet 14

Energy Guide 15

User Manual and Warranty 16

Feature Icons 18

DVE51CG8000 - Electric Dryer

DVG51CG8000 - Gas Dryer

Product Overview

Product Overview 20

Carousel Image Order 21

Product Messaging

Features and Benefits 24

Product Specs

Related Products and Accessories 29

Spec Sheets 30

User Manual and Warranty 32

Feature Icons 34

Product Overview

WF51CG8000AV
WF51CG8000AW

**5.1 cu. ft. Extra-Large Capacity Smart Front Load Washer
with Vibration Reduction Technology+**

Product Overview

Product Title

5.1 cu. ft. Extra-Large Capacity Smart Front Load Washer with Vibration Reduction Technology+

Product Description

Samsung's 5.1 cu. ft. Extra-Large Capacity Front Load Washing Machine comes integrated with Wi-Fi connectivity and SmartThings so you can receive end-of-cycle alerts and schedule laundry right from your smartphone.* It also has Vibration Reduction Technology+ for a quiet washing experience.

- Extra-Large 5.1 cu. ft. Capacity
- Wi-Fi Connectivity with SmartThings – Remotely start, schedule, and receive end-of-cycle alerts to your smartphone.*
- Vibration Reduction Technology+ – Reduces noise and vibration for quiet washing.
- Energy Star Most Efficient – Recognized for delivering cutting edge energy efficiency and innovation.**

*Requires wireless network, Samsung account and SmartThings App. Available on Android and iOS devices.

**Visit www.energystar.gov for more information on ENERGY STAR® guidelines.

Easy Ads Links

<https://dam.gettyimages.com/p/z0c3461/digital-appliances?o=AND&q=WF51CG8000AV>

<https://dam.gettyimages.com/p/z0c3461/digital-appliances?o=AND&q=WF51CG8000AW>

Available Colors

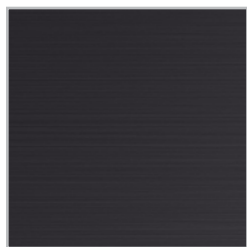

Brushed Black

Model Number: WF51CG8000AV

UPC: 887276785295



White

Model Number: WF51CG8000AW

UPC: 887276785301



Carousel Image Order

WF51CG8000AV

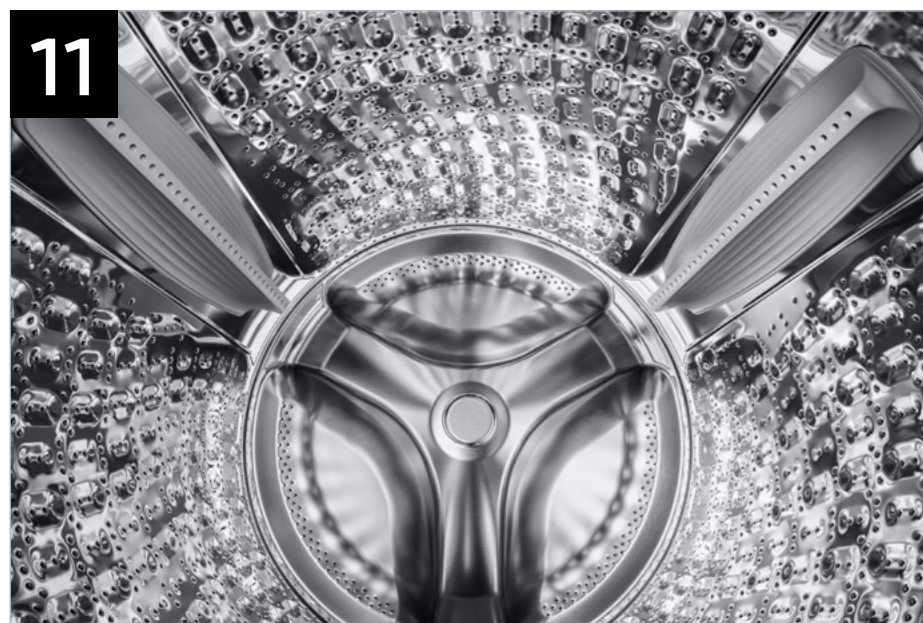

Carousel Image Order

WF51CG8000AW

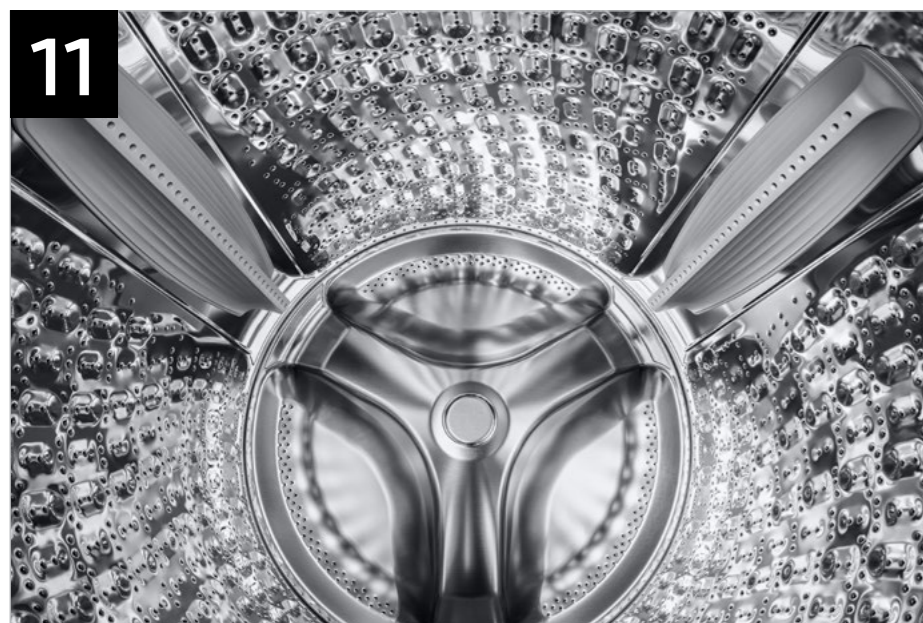



Product Messaging

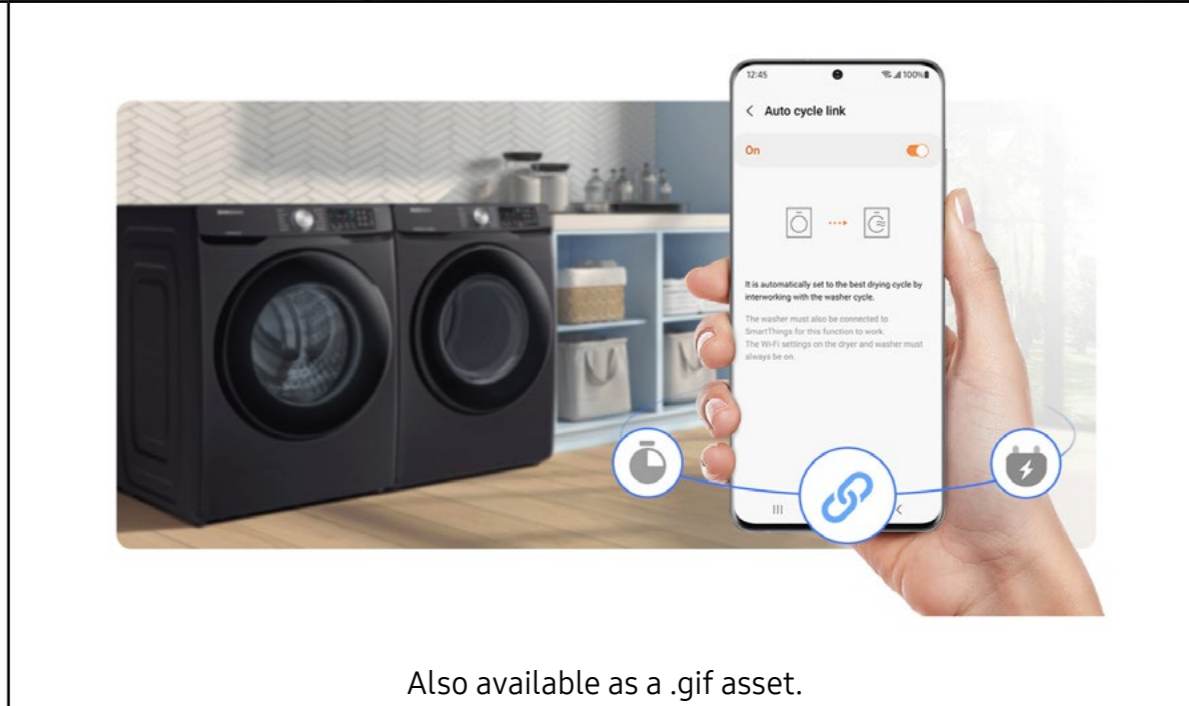

WF51CG8000AV
WF51CG8000AW

**5.1 cu. ft. Extra-Large Capacity Smart Front Load Washer
with Vibration Reduction Technology+**



Features and Benefits: WF51CG8000*

Headline	Feature Name	Long Body Copy	Short Body Copy	Associated Image
<p>Fit more for fewer loads</p>	<p>Extra-Large 5.1 cu. ft. Capacity</p>	<p>Extra-Large Capacity lets you wash more items in a single load, meaning fewer loads, less time in the laundry room, and more time doing the things you love.</p>	<p>Fewer loads, less time in the laundry room.</p>	
<p>Control in the palm of your hand</p>	<p>Wi-Fi Connectivity with SmartThings</p>	<p>The SmartThings App sends you end of cycle notifications and lets you remotely start, stop, or delay your washer from your phone.*</p> <p><small>*Requires wireless network, Samsung account and SmartThings App. Available on Android and iOS devices.</small></p>	<p>The SmartThings App sends you end of cycle notifications and lets you remotely start, stop, or delay your washer from your phone.*</p> <p><small>*Requires wireless network, Samsung account and SmartThings App. Available on Android and iOS devices.</small></p>	 <p>Also available as a .gif asset.</p>
<p>Quiet washing anytime, any place</p>	<p>Vibration Reduction Technology+</p>	<p>Do your laundry in peace. Our innovative Vibration Reduction Technology+ reduces noise and vibration and creates a quiet washing experience.</p>	<p>Reduces noise and vibration for quiet washing.</p>	

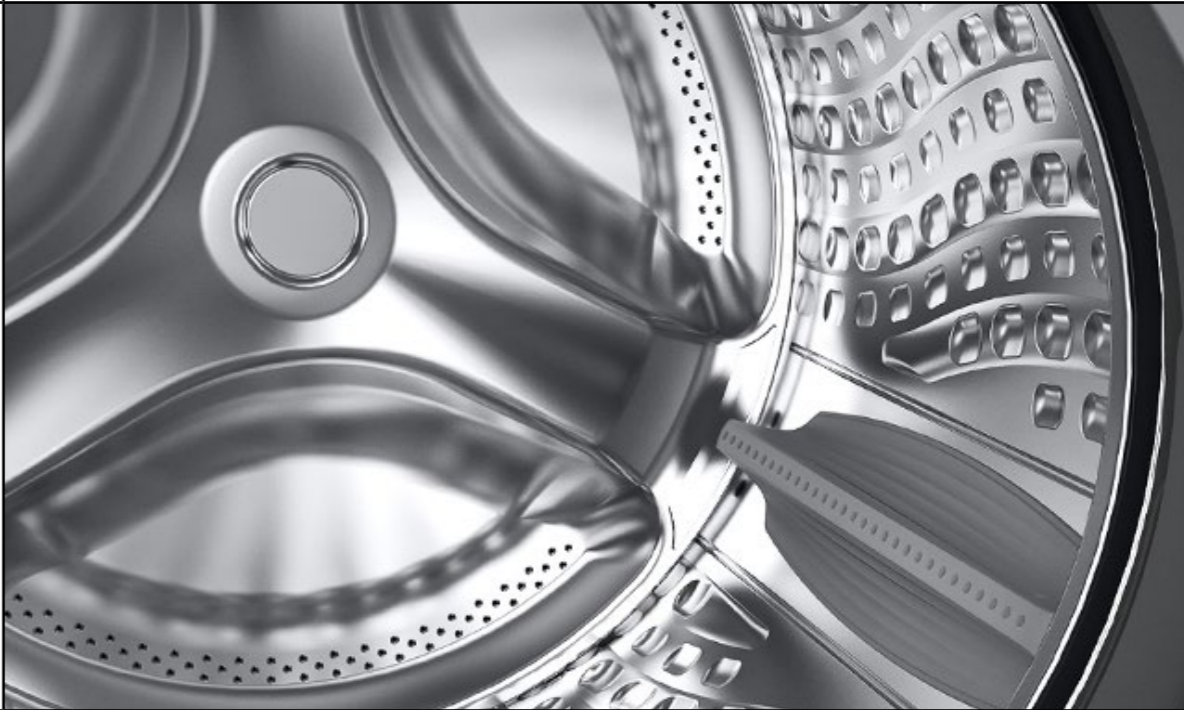

Features and Benefits: WF51CG8000* (Continued)

Headline	Feature Name	Long Body Copy	Short Body Copy	Associated Image
N/A	Energy Star® Most Efficient	<p>Samsung washers are recognized by the EPA in delivering cutting edge energy efficiency along with the latest in technological innovation.*</p> <p>*Visit www.energystar.gov for more information on ENERGY STAR® guidelines.</p>	<p>Recognized for delivering cutting edge energy efficiency and innovation.*</p> <p>*Visit www.energystar.gov for more information on ENERGY STAR® guidelines.</p>	
Keep your washer fresh and clean	Self Clean+	<p>Self Clean+ cleans the inside of your washer to keep it smelling fresh and will also remind you every 40 wash cycles when it is time for a cleaning.</p>	<p>Self Clean+ cleans the inside of your washer and will remind you every 40 cycles when it is time for a cleaning.</p>	
Purchase with confidence	20-Year Motor Warranty	<p>Samsung washing machines are covered by a 20-Year Warranty on the Digital Inverter Motor.* Purchase with confidence, and enjoy superior efficiency and long-lasting performance.*</p> <p>*20-year warranty limited to the Digital Inverter Motor purchased on 7/1/2022 or later. Purchase receipt indicating purchase date required for a claim. Additional restrictions and limitations apply, see warranty for details</p>	<p>Samsung washing machines are covered by a 20-Year Warranty on the Digital Inverter Motor.*</p> <p>*20-year warranty limited to the Digital Inverter Motor purchased on 7/1/2022 or later. Purchase receipt indicating purchase date required for a claim. Additional restrictions and limitations apply, see warranty for details</p>	

Features and Benefits: WF51CG8000* (Continued)

Headline	Feature Name	Long Body Copy	Short Body Copy	Associated Image
N/A	Swirl+ Drum Interior	The improved drum pattern draws out more water during the rinse cycle and helps prevent clothes from snagging during the wash.	Improved drum pattern draws out water more quickly and helps prevent snags.	
Easy to troubleshoot	Smart Care	Easy troubleshooting from the convenience of your smartphone.* Smart Care interacts with your washer and dryer to perform an immediate diagnosis and offer quick solutions. <small>*Requires Samsung Smart Washer/Dryer App. The Samsung Smart Washer/Dryer App supports Android OS 2.3.6 or later and iOS 3 or later for iPhone models. Samsung Smart Washer/Dryer App available in App Store and Play Store.</small>	Easy troubleshooting from the convenience of your smartphone.* <small>*Requires Samsung Smart Washer/Dryer App. The Samsung Smart Washer/Dryer App supports Android OS 2.3.6 or later and iOS 3 or later for iPhone models. Samsung Smart Washer/Dryer App available in App Store and Play Store.</small>	
Fits any space	Flexible Installation	Install your washer and dryer stacked or side by side to fit any space.	Install your washer and dryer stacked or side by side to fit any space.	

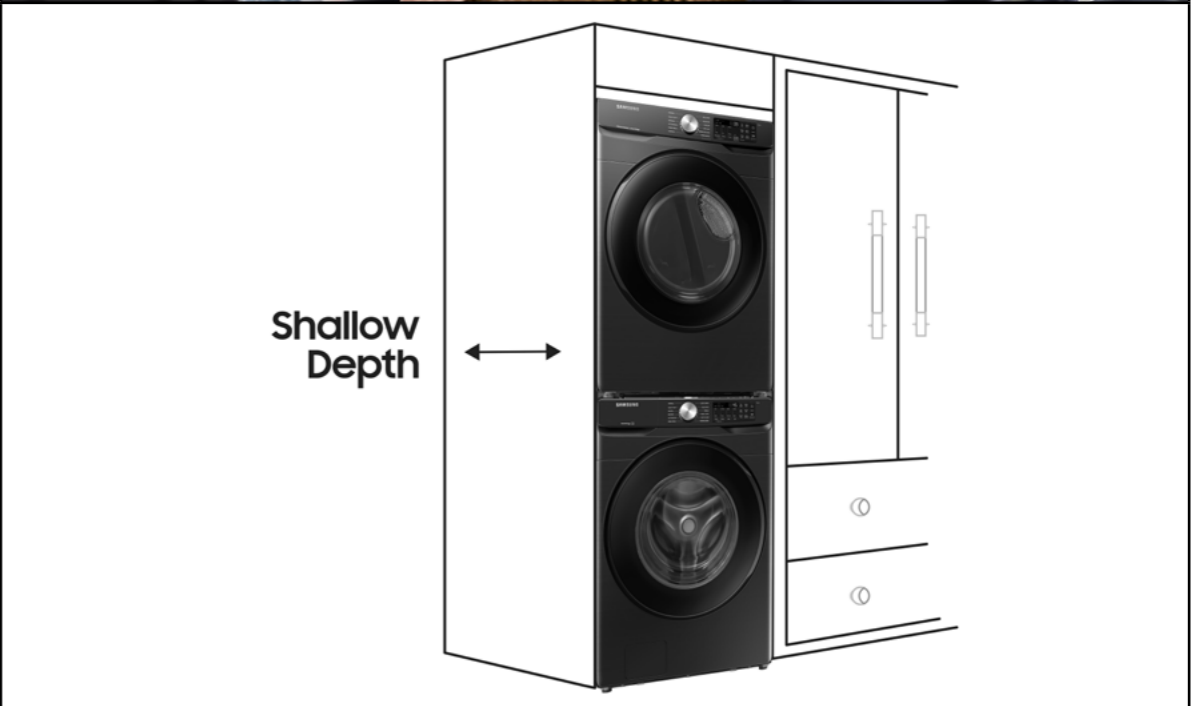
Features and Benefits: WF51CG8000* (Continued)

Headline	Feature Name	Long Body Copy	Short Body Copy	Associated Image
<p>Easier use, for everyone</p>	<p>ADA Compliant</p>	<p>With use of a Samsung Riser,* your washer or dryer is compliant with the Americans with Disabilities Act (ADA), making loading and unloading much easier.</p> <p><small>*ADA Compliant when using 27" wide riser. (Riser model codes: WE272NV, WE272NW)</small></p>	<p>Designed for easy use for everyone.*</p> <p><small>*ADA Compliant when using 27" wide riser. (Riser model codes: WE272NV, WE272NW)</small></p>	
<p>Space-Saving Design</p>	<p>Closet-Depth Fit*</p> <p><small>*Designed to fit a 40" installation depth.</small></p>	<p>Perfect for any laundry space, this washer has a shallower depth for an easy installation into closets without sacrificing any washing capacity.</p>	<p>A shallower depth allows for an easy installation into closets without sacrificing washing capacity.</p>	
<p>Perfect pair</p>	<p>Matching Accessories</p>	<p>Round out your laundry setup with a matching dryer, pedestal, riser, and more.</p>	<p>N/A</p>	

Product Specs

WF51CG8000AV
WF51CG8000AW

**5.1 cu. ft. Extra-Large Capacity Smart Front Load Washer
with Vibration Reduction Technology+**

Related Products and Accessories

Dryer Series	Pedestal	Riser	Stacking Kit
DVE51CG8000V DVG51CG8000V DVE51CG8000W DVG51CG8000W	WE402NV WE402NW	WE272NV WE272NW	SKK-8K

Spec Sheet

WF51CG8000

5.1 cu. ft. Extra-Large Capacity Smart Front Load Washer with Vibration Reduction Technology+



SAMSUNG

Available Colors

- Brushed Black**
WF51CG8000AV
- White**
WF51CG8000AW

Features

- Extra-Large 5.1 cu. ft. Capacity
- Wi-Fi Connectivity with SmartThings+
- Vibration Reduction Technology+
- ENERGY STAR® Most Efficient
- 20-Year Motor Warranty
- Self Clean+
- Swirl+ Drum Interior
- Smart Care
- Flexible Installation
- ADA Compliant*
- Closet-Depth Fit†
- 12 Preset Washing Cycles
- 1200 RPM Maximum Spin Speed
- Digital Inverter Motor
- 7 Washing Options
- 5 Temperature Settings

Specifications

12 Preset Washing Cycles: Normal, Heavy Duty, Bedding, Quick Wash, Permanent Press, Delicates, Whites, Activewear, Towels, Rinse+Spin, Self Clean+, Downloads

6 Downloadable Washing Cycles: Wool, Eco Cold, Colors, Outdoor, Denim, Power Rinse

7 Washing Options: Pre Soak, Delay End, Smart Control, Smart Care, Spin Only, Sound Off, Child Lock

5 Temperature Settings: Hot, Warmer, Warm, Cool, Cold

5 Spin Settings: High, Medium High, Medium, Low, No Spin

5 Soil Settings: Heavy, Medium Heavy, Normal, Medium Low, Light

Warranty
One (1) Year Parts and Labor
Three (3) Years Stainless Steel Tub (Part Only)
Twenty (20) Years; Washing DIT (Digital Inverter Motor) Motor Part (Part Only)

Product Dimensions & Weight (WxHxD)
Dimensions: 27" x 38 3/4" x 33 1/2"
Weight: 216.1 lbs

Shipping Dimensions & Weight (WxHxD)
Dimensions: 29 1/2" x 42 3/8" x 35 1/8"
Weight: 220.5 lbs

Convenience

- Child Lock
- Dispenser Trays: Main Wash, Softener, Bleach

Ratings

Most Efficient 2023

CEE Tier 3
IMEF = 3.1
IWF = 2.9
95 kWh/yr

Electrical Requirements

120 V / 60 Hz
15 Amps

Washer	Model #	UPC Code
Brushed Black	WF51CG8000AV	887276785295
White	WF51CG8000AW	887276785301

Matching Electric Dryer	Model #	UPC Code
Brushed Black	DVE51CG8000V	887276783550
White	DVE51CG8000W	887276783567

Matching Gas Dryer	Model #	UPC Code
Brushed Black	DVG51CG8000V	887276783598
White	DVG51CG8000W	887276783604

Washer Spec Sheet - page 1

WF51CG8000

5.1 cu. ft. Extra-Large Capacity Smart Front Load Washer with Vibration Reduction Technology+

SAMSUNG

Installation Specifications – Side-by-Side

Required dimensions for installation with pedestal:

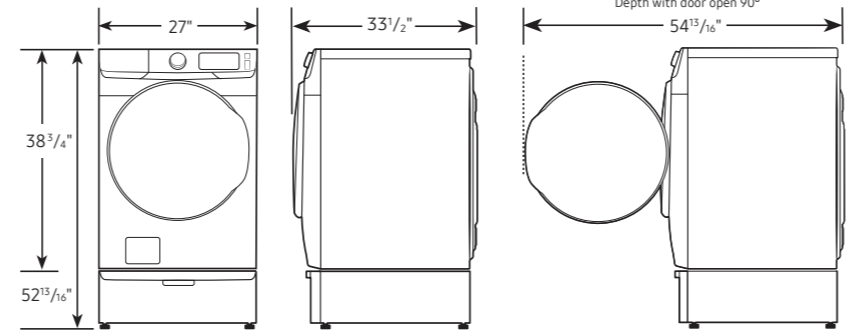

Installation Specifications – Side-by-Side

If the washer and dryer are installed together or the dryer alone, the closet front must have two unobstructed air openings for a combined minimum total area of 72-inch². Your washer alone does not require a specific air opening.

Alcove or closet installation
Minimum clearance for closet and alcove installations:

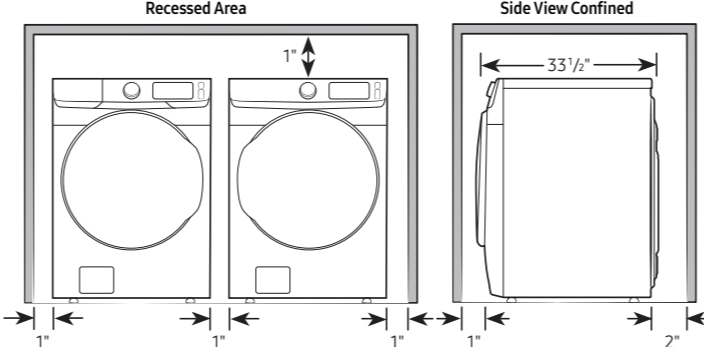

Connection Dimensions

Back view of washer

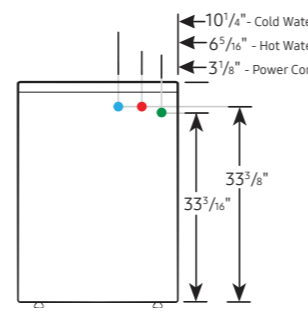

LEGEND:

- Cold Water Connection
- Hot Water Connection
- Power Cord

Actual color may vary. Design, specifications, and color availability are subject to change without notice. Non-metric weights and measurements are approximate.

©2023 Samsung Electronics America, Inc., 81 Challenger Road, Ridgefield Park, NJ 07660. Tel: 800-SAMSUNG, samsung.com. Samsung is a registered trademark of Samsung Electronics Co., Ltd.

Washer Spec Sheet - page 2

WF51CG8000

5.1 cu. ft. Extra-Large Capacity Smart Front Load Washer with Vibration Reduction Technology+

SAMSUNG

Installation Specifications – Stacked Pair

Clearances indicated are for stacked pairs. The closet front must have two unobstructed air openings for a combined minimum total area of 72-inch².

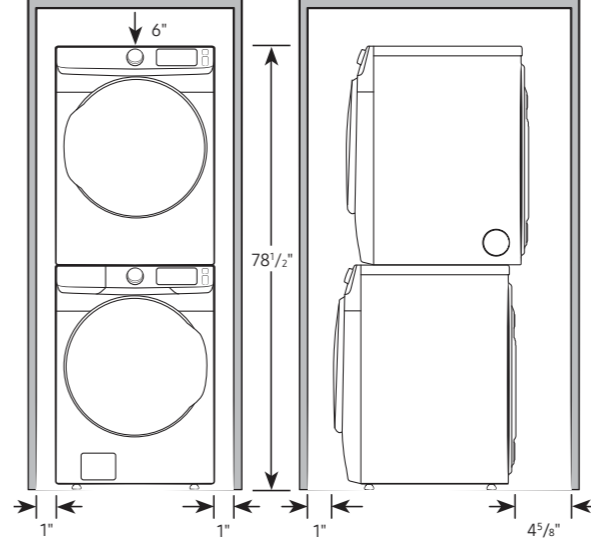

Connection Dimensions

Back and side views of stacked pair

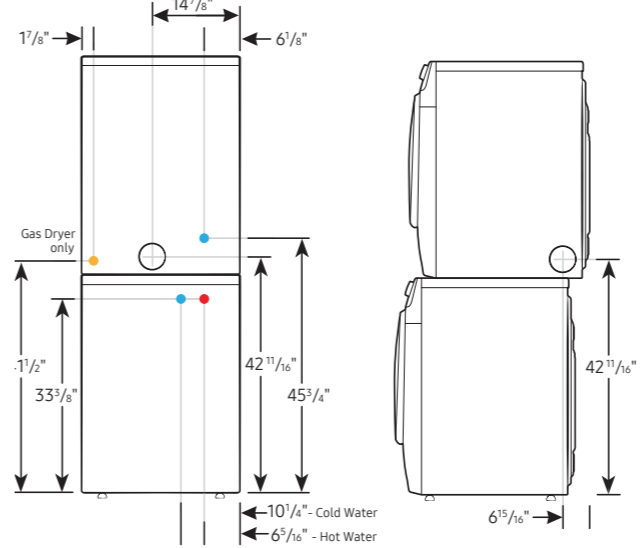

LEGEND:

- Cold Water Connection
- Hot Water Connection
- Gas Connection

Actual color may vary. Design, specifications, and color availability are subject to change without notice. Non-metric weights and measurements are approximate.

©2023 Samsung Electronics America, Inc., 81 Challenger Road, Ridgefield Park, NJ 07660. Tel: 800-SAMSUNG, samsung.com. Samsung is a registered trademark of Samsung Electronics Co., Ltd.

Washer Spec Sheet - page 3

Energy Guide

U.S. Government Federal law prohibits removal of this label before consumer purchase.

ENERGYGUIDE

Clothes Washer
Capacity Class: Standard

Samsung
Models WF51CG80**A*
Capacity (tub volume): 5.1 cubic feet

Compare ONLY to other labels with yellow numbers.
Labels with yellow numbers are based on the same test procedures.

Estimated Yearly Energy Cost
(when used with an electric water heater)

\$13

\$4 \$48

Cost Range of Similar Models

93 kWh
Estimated Yearly Electricity Use

\$9
Estimated Yearly Energy Cost
(when used with a natural gas water heater)

- Your cost will depend on your utility rates and use.
- Cost range based only on standard capacity models.
- Estimated energy cost based on six wash loads a week and a national average electricity cost of 14 cents per kWh and natural gas cost of \$1.21 per therm.

ftc.gov/energy



Energy Guide

User Manual and Warranty

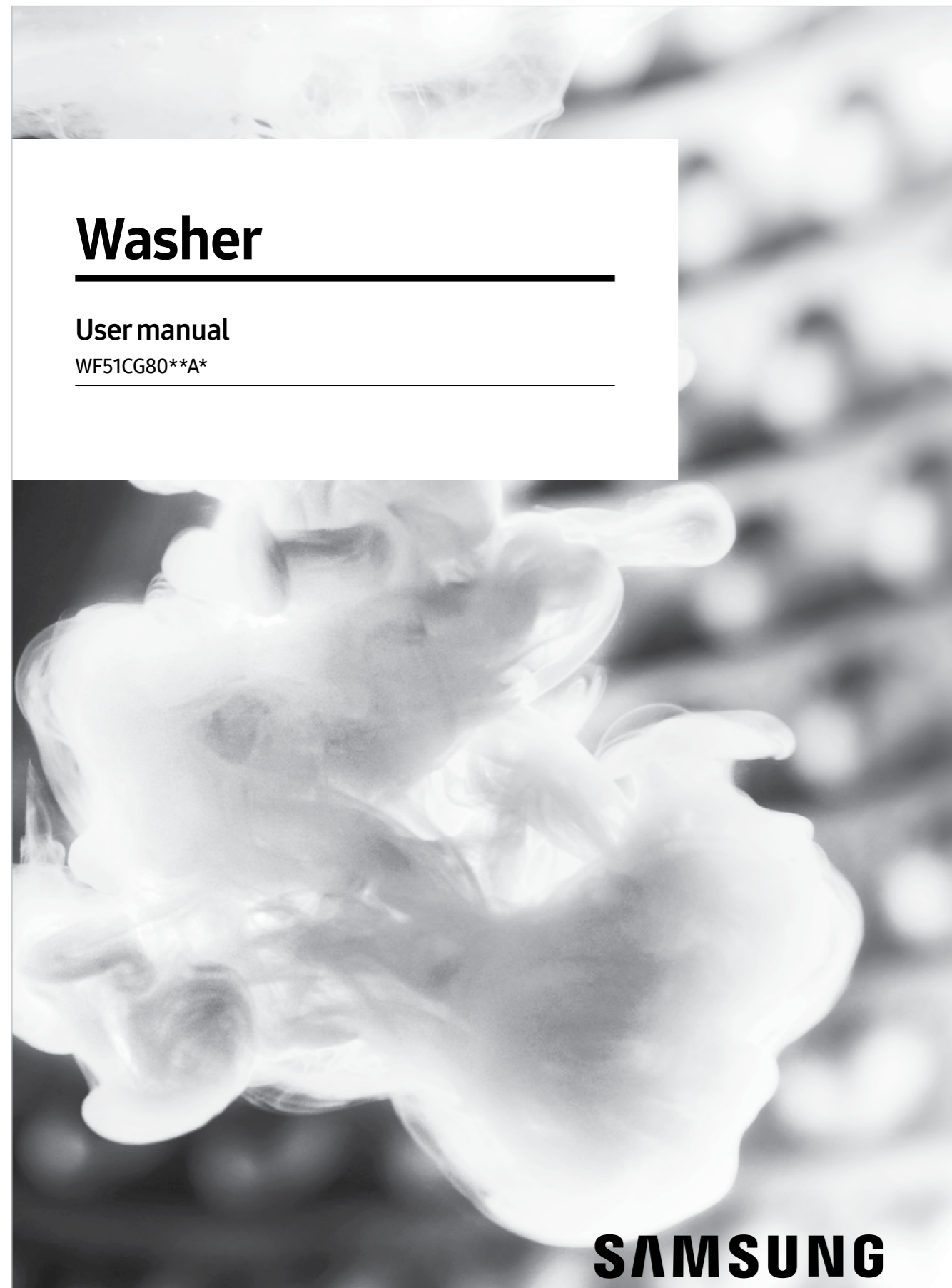

User Manual

LIMITED WARRANTY (U.S.A.) – SAMSUNG WASHER

Models:
WF51CG8000AV
WF51CG8000AW

LIMITED WARRANTY TO ORIGINAL PURCHASER WITH PROOF OF PURCHASE

This SAMSUNG brand product, as supplied and distributed by SAMSUNG ELECTRONICS AMERICA, INC. (SAMSUNG) and delivered new, in the original carton to the original consumer purchaser, is warranted by SAMSUNG against manufacturing defects in materials or workmanship for the limited warranty period, starting from the date of original purchase, of:

One (1) year Parts and labor
Three (3) years Stainless tub part (Part Only)
Twenty (20) years; Washing DIT (Digital Inverter Motor) motor part (Part Only)

This limited warranty is valid only on products purchased and used in the United States that have been installed, operated, and maintained according to the instructions attached to or furnished with the product. To receive warranty service, the purchaser must contact SAMSUNG at the address or phone number provided below for problem determination and service procedures. Warranty service can only be performed by a SAMSUNG authorized service center. The original dated bill of sale must be presented upon request as proof of purchase to SAMSUNG or SAMSUNG's authorized service center to receive warranty service.

SAMSUNG will provide in-home service within the contiguous United States during the warranty period at no charge, subject to availability of SAMSUNG authorized servicers within the customer's geographic area. If in-home service is not available, SAMSUNG may elect, at its option, to provide transportation of the product to and from an authorized service center. If the product is located in an area where service by a SAMSUNG authorized servicer is not available, you may be responsible for a trip charge or require to bring the product to a SAMSUNG authorized service center for service.

To receive in-home service, product must be unobstructed and accessible to the service agent.

During the applicable warranty period, a product will be repaired, replaced, or the purchase price refunded, at the sole option of SAMSUNG. SAMSUNG may use new or reconditioned parts in repairing a product, or replace the product with a new or reconditioned product. Replacement parts and products are warranted for the remaining portion of the original product's warranty or ninety (90) days, whichever is longer. All replaced parts and products are the property of SAMSUNG and you must return them to SAMSUNG.

This limited warranty covers manufacturing defects in materials or workmanship encountered in normal household, noncommercial use of this product and shall not cover the following: damage that occurs in shipment, delivery, installation, and uses for which this product was not intended; damage caused by unauthorized modification or alteration of the product; product where the original factory serial numbers have been removed, defaced, changed in any way, or cannot be readily determined; cosmetic damage including scratches, dents, chips, and other damage to the product's finishes; damage caused by abuse, misuse, pest infestations, accident, fire, floods, or other acts of nature or God; damage caused by use of equipment, utilities, services, parts, supplies,

Warranty

Feature Icons

WF51CG8000AV
WF51CG8000AW

**5.1 cu. ft. Extra-Large Capacity Smart Front Load Washer
with Vibration Reduction Technology+**

Feature Icons

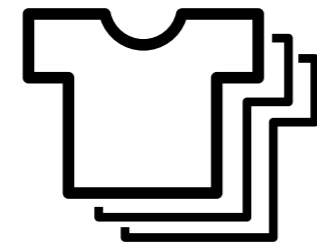

Extra-Large 5.1 cu. ft. Capacity

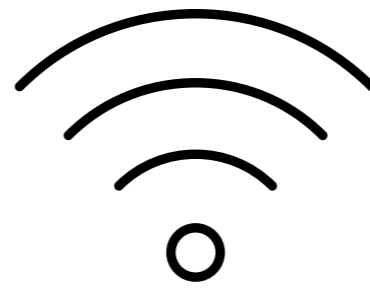

Wi-Fi Connectivity with SmartThings



Vibration Reduction Technology+



Energy Star® Most Efficient

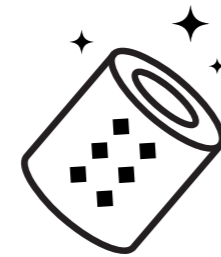

Self Clean+



Smart Care



20-Year Warranty*

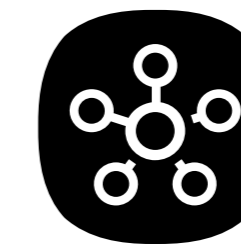

SmartThings

*20-year warranty limited to the Digital Inverter Motor of washers purchased on 7/1/2022 or later. Purchase receipt indicating purchase date required for a claim. Additional restrictions and limitations apply, see warranty for details.

Product Overview

DVE51CG8000V / DVG51CG8000V
DVE51CG8000W / DVG51CG8000W

7.5 cu. ft. Smart Electric Dryer with Sensor Dry
7.5 cu. ft. Smart Gas Dryer with Sensor Dry

Product Overview

Product Titles

DVE51CG8000V, DVE51CG8000W – 7.5 cu. ft. Smart Electric Dryer with Sensor Dry

DVG51CG8000V, DVG51CG8000W – 7.5 cu. ft. Smart Gas Dryer with Sensor Dry

Electric Dryer Description

Samsung's 7.5 cu. ft. Large Capacity Front Load Electric Dryer comes integrated with Wi-Fi connectivity and SmartThings so you can receive end-of-cycle alerts and schedule laundry right from your smartphone.* It also features worry-free drying with Sensor Dry to help prevent over-drying for optimal fabric care.

Gas Dryer Description

Samsung's 7.5 cu. ft. Large Capacity Front Load Gas Dryer comes integrated with Wi-Fi connectivity and SmartThings so you can receive end-of-cycle alerts right from your smartphone.* It also features worry-free drying with Sensor Dry to help prevent over-drying for optimal fabric care.

Electric & Gas Dryer Bullets

- Large 7.5 cu. ft. Capacity
- Wi-Fi Connectivity with SmartThings – Remotely start, schedule, and receive end-of-cycle alerts to your smartphone*
- Sensor Dry – helps prevent over drying for optimal fabric care
- Interior Drum Light – easily see contents in your dryer more clearly
- Reversible Door – choose which way your dryer door opens
- Lint Filter Indicator – helpful reminder to help keep your dryer running smoothly

*Requires wireless network, Samsung account and SmartThings App. Available on Android and iOS devices. Only monitoring enabled on Gas Dryers for safety reasons.

Easy Ads Links

<https://dam.gettyimages.com/p/z0c3461/digital-appliances?o=AND&q=DVE51CG8000V>

<https://dam.gettyimages.com/p/z0c3461/digital-appliances?o=AND&q=DVE51CG8000W>

Available Colors



Brushed Black

Electric Dryer Model Number: DVE51CG8000V

Electric Dryer UPC: 887276783550

Gas Dryer Model Number: DVG51CG8000V

Gas Dryer UPC: 887276783598

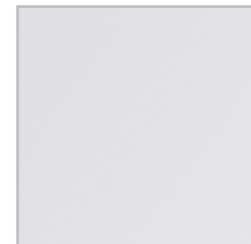

White

Electric Dryer Model Number: DVE51CG8000W

Electric Dryer UPC: 887276783567

Gas Dryer Model Number: DVG51CG8000W

Gas Dryer UPC: 887276783604

Carousel Image Order

DVE51CG8000V / DVG51CG8000V



Carousel Image Order

DVE51CG8000W / DVG51CG8000W





Product Messaging

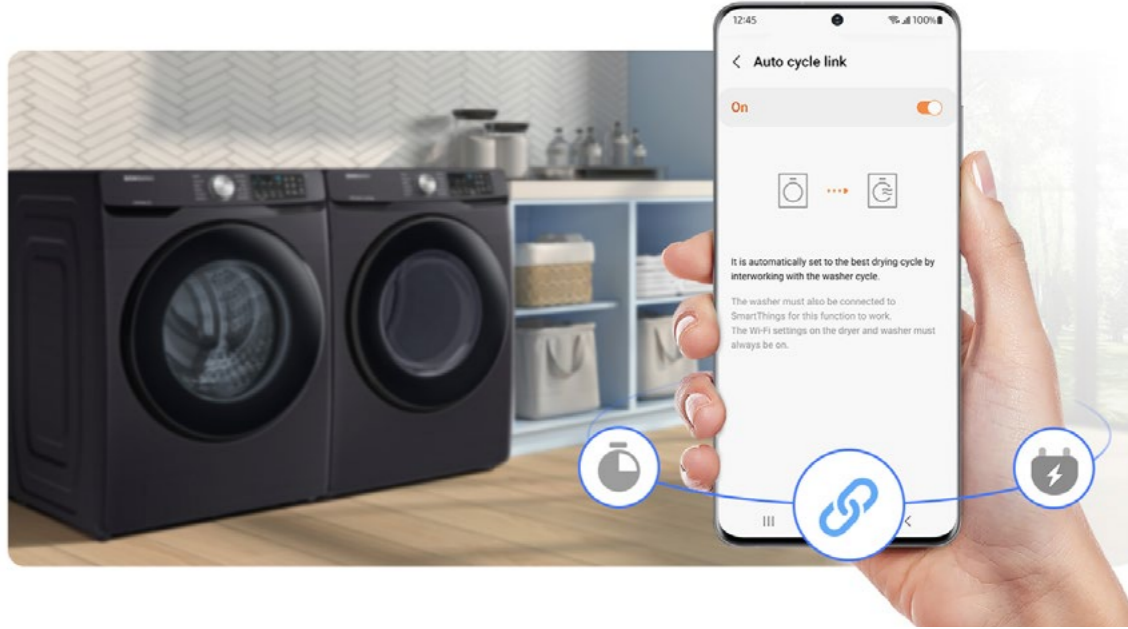

DVE51CG8000V / DVG51CG8000V
DVE51CG8000W / DVG51CG8000W

7.5 cu. ft. Smart Electric Dryer with Sensor Dry
7.5 cu. ft. Smart Gas Dryer with Sensor Dry



Features and Benefits: DVE(G)51CG8000*

Headline	Feature Name	Long Body Copy	Short Body Copy	Associated Image
<p>Worry-free drying</p>	<p>Sensor Dry</p>	<p>Automatically optimizes the time and temperature of your drying cycle to protect your clothes from heat damage, while avoiding excess energy use.</p>	<p>Helps prevent overdrying for optimal fabric care.</p>	 <p>Also available as an .mp4 asset.</p>
<p>Control in the palm of your hand</p>	<p>Wi-Fi Connectivity with SmartThings</p>	<p>Wi-Fi connected so you can get end-of-cycle alerts, remotely start and stop your wash, schedule cycles on your time and more, right from your smartphone with the SmartThings App.*</p> <p><small>*Requires wireless network, Samsung account and SmartThings App. Available on Android and iOS devices. Only monitoring enabled on Gas Dryers for safety reasons.</small></p>	<p>Get end of cycle alerts, remotely start, schedule, and more from your smartphone with the SmartThings App.*</p> <p><small>*Requires wireless network, Samsung account and SmartThings App. Available on Android and iOS devices. Only monitoring enabled on Gas Dryers for safety reasons.</small></p>	 <p>Also available as a .gif asset.</p>
<p>Fit more for fewer loads</p>	<p>Large 7.5 cu. ft. Capacity</p>	<p>Fewer loads, less time in the laundry room, and more time doing the things you love.</p>	<p>Fewer loads, less time in the laundry room.</p>	

Features and Benefits: DVE(G)51CG8000* (Continued)

Headline	Feature Name	Long Body Copy	Short Body Copy	Associated Image
N/A	Interior Drum Light	An internal drum light lets you see the contents of your dryer more clearly, meaning fewer missed socks or small items.	An internal drum light lets you see the contents of your dryer more clearly.	
Flexible opening	Reversible Door	Choose which way your dryer door opens to better suit your laundry room layout.	Choose which way your dryer door opens.	
Stop the fluff	Lint Filter Indicator	Worry less about lint or fluff blocking the dryer's air intake. The control panel provides a helpful reminder to clean the filter to keep your dryer running smoothly.	Worry less about lint or fluff blocking the dryer's air intake. The control panel provides a helpful reminder to clean the filter to keep your dryer running smoothly.	 <p data-bbox="2625 1735 2925 1759">Also available as an .mp4 asset.</p>

Features and Benefits: DVE(G)51CG8000* (Continued)

Headline	Feature Name	Long Body Copy	Short Body Copy	Associated Image
<p>Easy to troubleshoot</p>	<p>Smart Care</p>	<p>Easy troubleshooting from the convenience of your smartphone.* Smart Care interacts with your washer and dryer to perform an immediate diagnosis and offer quick solutions.</p> <p>*Requires Samsung Smart Washer/Dryer App. The Samsung Smart Washer/Dryer App supports Android OS 2.3.6 or later and iOS 3 or later for iPhone models. Samsung Smart Washer/Dryer App available in App Store and Play Store.</p>	<p>Easy troubleshooting from the convenience of your smartphone.*</p> <p>*Requires Samsung Smart Washer/Dryer App. The Samsung Smart Washer/Dryer App supports Android OS 2.3.6 or later and iOS 3 or later for iPhone models. Samsung Smart Washer/Dryer App available in App Store and Play Store.</p>	
<p>Fits any space</p>	<p>Flexible Installation</p>	<p>Install your washer and dryer stacked or side by side to fit any space.</p>	<p>Install your washer and dryer stacked or side by side to fit any space.</p>	
<p>Easier use, for everyone</p>	<p>ADA Compliant</p>	<p>With use of a Samsung Riser,* your washer or dryer is compliant with the Americans with Disabilities Act (ADA), making loading and unloading much easier.</p> <p>*ADA Compliant when using 27" wide riser. (Riser model codes: WE272NV, WE272NW)</p>	<p>Designed for easy use for everyone.*</p> <p>*ADA Compliant when using 27" wide riser. (Riser model codes: WE272NV, WE272NW)</p>	

Features and Benefits: DVE(G)51CG8000* (Continued)

Headline	Feature Name	Long Body Copy	Short Body Copy	Associated Image
Perfect pair	Matching Accessories	Round out your laundry setup with a matching washer, pedestal, riser and more.	N/A	

Product Specs

DVE51CG8000V / DVG51CG8000V
DVE51CG8000W / DVG51CG8000W

7.5 cu. ft. Smart Electric Dryer with Sensor Dry
7.5 cu. ft. Smart Gas Dryer with Sensor Dry

Related Products and Accessories

Washer Series	Pedestal	Riser	Stacking Kit	Gas to Propane Converter Kit	Side Vent Kit
WF51CG8000AV WF51CG8000AW	WE402NV WE402NW	WE272NV WE272NW	SKK-8K	LPKIT-4	DV-2A

Spec Sheet

DVE51CG8000

7.5 cu. ft. Smart Electric Dryer with Sensor Dry



SAMSUNG

Available Colors

- Brushed Black
DVE51CG8000V
- White
DVE51CG8000W

Features

- Sensor Dry
- Wi-Fi Connectivity with SmartThings¹
- Large 7.5 cu. ft. Capacity
- Interior Drum Light
- Reversible Door
- Lint Filter Indicator
- Smart Care
- Flexible Installation
- ADA Compliant²
- 12 Preset Drying Cycles
- 10 Options
- 5 Temperature Settings
- Accessibility (AUI, Braille)
- 4-Way Venting (Back, Bottom, Left, Right)

Convenience

- Child Lock
- Lint Filter Indicator

Ratings

644 kWh/yr

Electrical Requirements

240 V / 60 Hz
30 Amps

Specifications

12 Preset Drying Cycles:
Normal, Heavy Duty, Permanent Press, Activewear, Bedding, Delicates, Sanitize, Time Dry, Air Fluff, Quick Dry, Wrinkle Release, Downloaded

7 Downloadable Drying Cycles:
Eco Normal, Towels, Wool, Shirts, Denim, Low Temp, Rack Dry

10 Options:
Damp Alert, Wrinkle Prevent, Smart Control, Adjust Time (Up), Adjust Time (Down), Eco Dry, Sound Off, Drum Light, Smart Care, Child Lock

5 Temperature Settings:
High, Medium High, Medium, Medium Low, Low

5 Dry Levels:
More Dry, Normal-More Dry, Normal Dry, Normal-Less Dry, Less Dry

Warranty
One (1) Year Parts and Labor

Product Dimensions & Weight (WxHxD)
Dimensions: 27" x 38¹/₄" x 31¹/₁₆"
Weight: 119.0 lbs

Shipping Dimensions & Weight (WxHxD)
Dimensions: 29³/₈" x 42¹/₈" x 34¹/₁₆"
Weight: 125.7 lbs

Electric Dryer	Model #	UPC Code	Optional Accessories	Model #	UPC Code
Brushed Black	DVE51CG8000V	887276783550	Brushed Black/Black Stainless Steel Pedestal	WE402NV	887276310145
White	DVE51CG8000W	887276783567	White Pedestal	WE402NW	887276310152
Brushed Black	DVG51CG8000V	887276783598	Brushed Black/Black Stainless Steel Riser	WE272NV	887276197630
White	DVG51CG8000W	887276783604	White Riser	WE272NW	887276197647
			Stacking Kit	SKK-8K	887276344034
			Vent Kit	DV-2A	887276146416

¹Requires wireless network, Samsung account and SmartThings App. The Samsung SmartThings App supports Android OS 4.0 (ICS) or later which is optimized for Samsung smartphones (Galaxy S and Galaxy Note series). This app also supports iOS 7 or later for iPhone models. SmartThings App available in App Store and Play Store. Only monitoring enabled on Gas Dryers for safety reasons.

²ADA Compliant when using 27" wide riser. (Riser model codes: WE272NV, WE272NWC)

DVE51CG8000

7.5 cu. ft. Smart Electric Dryer with Sensor Dry

SAMSUNG

Dimensions
Required dimensions for installation with pedestal.

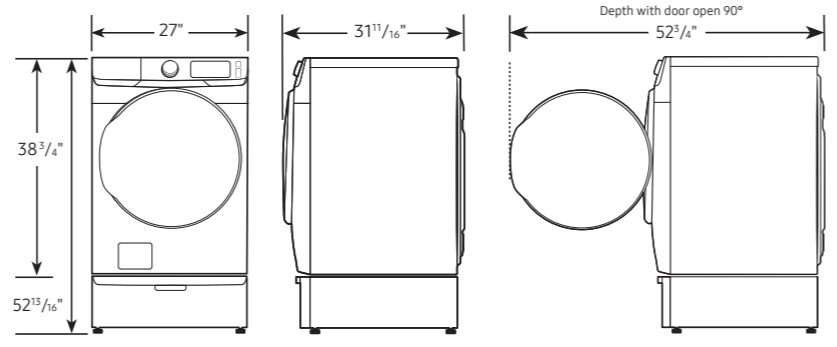

Installation Specifications – Side-by-Side
If the washer and dryer are installed together or the dryer alone, the closet front must have two unobstructed air openings for a combined minimum total area of 72-inch². Your washer alone does not require a specific air opening.

Alcove or closet installation
Minimum clearance for closet and alcove installations:

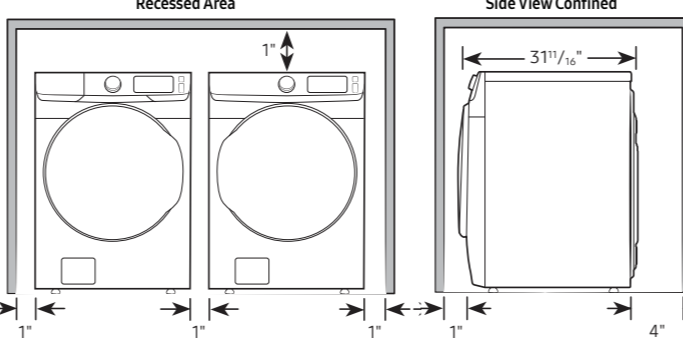

Connection Dimensions
Back and side view of dryer

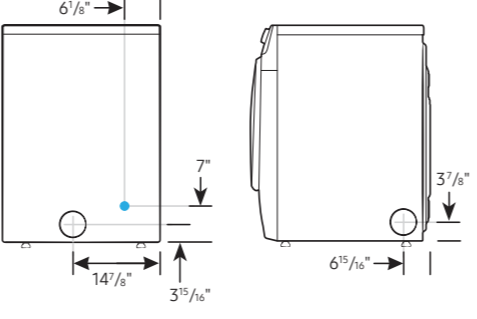

LEGEND:
● Cold Water Connection
● Hot Water Connection

Actual color may vary. Design, specifications, and color availability are subject to change without notice. Non-metric weights and measurements are approximate.

©2023 Samsung Electronics America, Inc. 85 Challenger Road, Ridgefield Park, NJ 07660. Tel: 800-243-5262. samsung.com. Samsung is a registered trademark of Samsung Electronics Co., Ltd.

Electric Dryer Spec Sheet - page 2

DVE51CG8000

7.5 cu. ft. Smart Electric Dryer with Sensor Dry

SAMSUNG

Installation Specifications – Stacked Pair
Clearances indicated are for stacked pairs. The closet front must have two unobstructed air openings for a combined minimum total area of 72-inch².

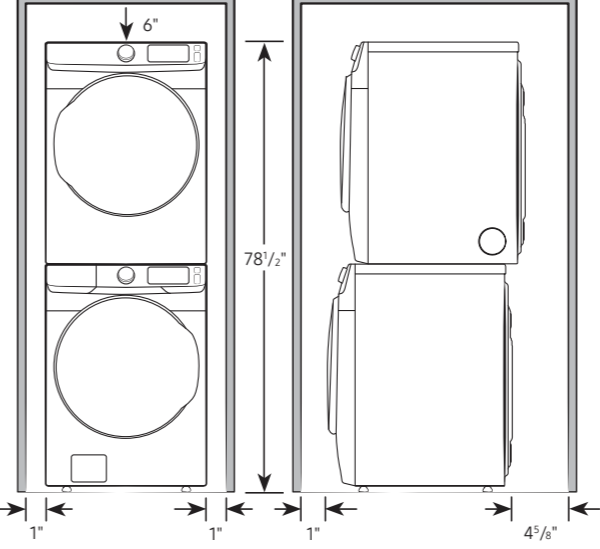

Connection Dimensions
Back and side views of stacked pair

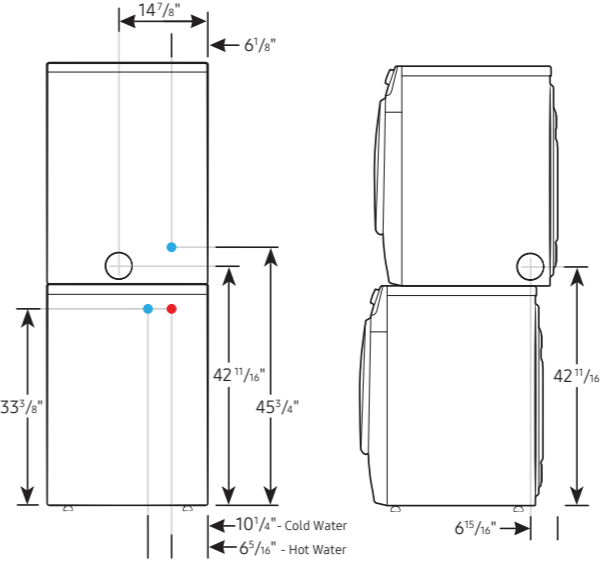

LEGEND:
● Cold Water Connection
● Hot Water Connection

Actual color may vary. Design, specifications, and color availability are subject to change without notice. Non-metric weights and measurements are approximate.

©2023 Samsung Electronics America, Inc. 85 Challenger Road, Ridgefield Park, NJ 07660. Tel: 800-243-5262. samsung.com. Samsung is a registered trademark of Samsung Electronics Co., Ltd.

Electric Dryer Spec Sheet - page 3

Spec Sheet

DVG51CG8000

7.5 cu. ft. Smart Gas Dryer with Sensor Dry



SAMSUNG

Available Colors

- Brushed Black**
DVG51CG8000V
- White**
DVG51CG8000W

Features

- Sensor Dry
- Wi-Fi Connectivity with SmartThings¹
- Large 7.5 cu. ft. Capacity
- Interior Drum Light
- Reversible Door
- Lint Filter Indicator
- Smart Care
- Flexible Installation
- ADA Compliant²
- 12 Preset Drying Cycles
- 10 Options
- 5 Temperature Settings
- Accessibility (AUI, Braille)
- 3-Way Venting (Back, Bottom, Left)

Specifications

12 Preset Drying Cycles:
Normal, Heavy Duty, Permanent Press, Activewear, Bedding, Delicates, Sanitize, Time Dry, Air Fluff, Quick Dry, Wrinkle Release, Downloaded

7 Downloadable Drying Cycles:
Eco Normal, Towels, Wool, Shirts, Denim, Low Temp, Rack Dry

10 Options:
Damp Alert, Wrinkle Prevent, Smart Monitor, Adjust Time (Up), Adjust Time (Down), Eco Dry, Sound Off, Drum Light, Smart Care, Child Lock

5 Temperature Settings:
High, Medium High, Medium, Medium Low, Low

5 Dry Levels:
More Dry, Normal-More Dry, Normal Dry, Normal-Less Dry, Less Dry

Warranty
One (1) Year Parts and Labor

Product Dimensions & Weight (WxHxD)
Dimensions: 27" x 38 1/4" x 31 1/16"
Weight: 119.0 lbs

Shipping Dimensions & Weight (WxHxD)
Dimensions: 29 3/16" x 42 7/16" x 34 1/16"
Weight: 125.7 lbs

Convenience

- Child Lock
- Lint Filter Indicator

Electrical Requirements

120 V / 60 Hz
15 Amps

Gas Dryer	Model #	UPC Code	Optional Accessories	Model #	UPC Code
Brushed Black	DVG51CG8000V	887276783598	Brushed Black/Black Stainless Steel Pedestal	WE402NV	887276310145
White	DVG51CG8000W	887276783604	White Pedestal	WE402NW	887276310152
Brushed Black	DVE51CG8000V	887276783550	Brushed Black/Black Stainless Steel Riser	WE272NV	887276197630
White	DVE51CG8000W	887276783567	White Riser	WE272NW	887276197647
			Stacking Kit	SKK-8K	887276344034
			Vent Kit	DV-2A	887276146416
			Gas to Propane Converter Kit	LPKIT-4	887276352787

¹Requires wireless network, Samsung account and SmartThings App. The Samsung SmartThings App supports Android OS 4.0 (ICS) or later which is optimized for Samsung smartphones (Galaxy S and Galaxy Note series). This app also supports iOS 7 or later for iPhone models. SmartThings App available in App Store and Play Store. Only monitoring enabled on Gas Dryers for safety reasons.

²ADA Compliant when using 27" wide riser. (Riser model codes: WE272NV, WE272NW)

©2022 Samsung Electronics America, Inc. 291 Challenger Road, Ridgefield Park, NJ 07663. Tel: 800-SAMSUNG. samsung.com. Samsung is a registered trademark of Samsung Electronics Co., Ltd.

Gas Dryer Spec Sheet - page 1

DVG51CG8000

7.5 cu. ft. Smart Gas Dryer with Sensor Dry

SAMSUNG

Dimensions
Required dimensions for installation with pedestal:

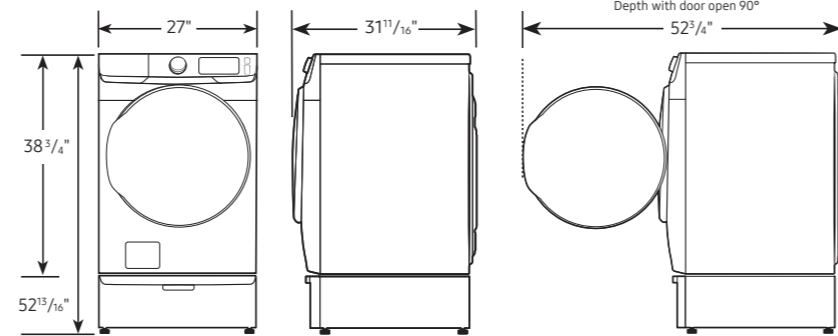

Installation Specifications – Side-by-Side
If the washer and dryer are installed together or the dryer alone, the closet front must have two unobstructed air openings for a combined minimum total area of 72-inch². Your washer alone does not require a specific air opening.

Alcove or closet installation
Minimum clearance for closet and alcove installations:

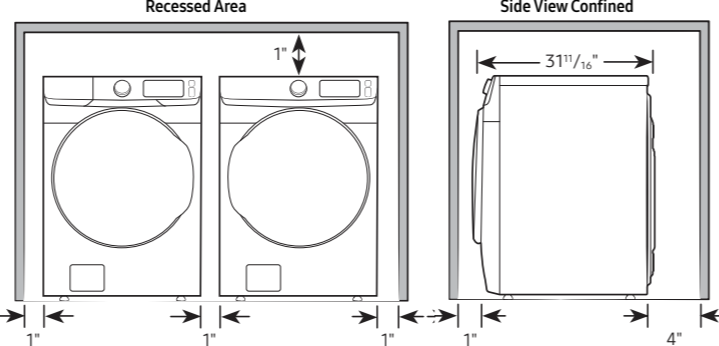

Connection Dimensions
Back and side view of dryer

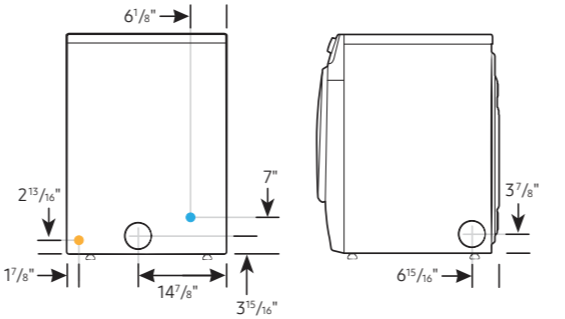

LEGEND:
● Cold Water Connection
● Hot Water Connection
● Gas Connection

Actual color may vary. Design, specifications, and color availability are subject to change without notice. Non-metric weights and measurements are approximate.

©2022 Samsung Electronics America, Inc. 291 Challenger Road, Ridgefield Park, NJ 07663. Tel: 800-SAMSUNG. samsung.com. Samsung is a registered trademark of Samsung Electronics Co., Ltd.

Gas Dryer Spec Sheet - page 2

DVG51CG8000

7.5 cu. ft. Smart Gas Dryer with Sensor Dry

SAMSUNG

Installation Specifications – Stacked Pair
Clearances indicated are for stacked pairs. The closet front must have two unobstructed air openings for a combined minimum total area of 72-inch².

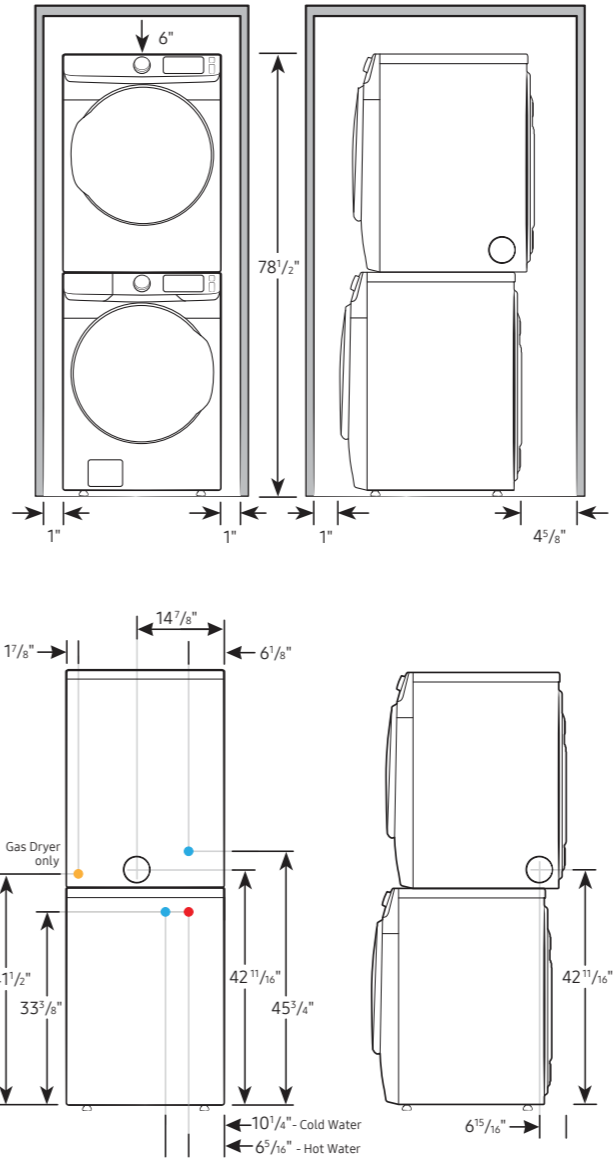

LEGEND:
● Cold Water Connection
● Hot Water Connection
● Gas Connection

Actual color may vary. Design, specifications, and color availability are subject to change without notice. Non-metric weights and measurements are approximate.

©2022 Samsung Electronics America, Inc. 291 Challenger Road, Ridgefield Park, NJ 07663. Tel: 800-SAMSUNG. samsung.com. Samsung is a registered trademark of Samsung Electronics Co., Ltd.

Gas Dryer Spec Sheet - page 3

User Manual and Warranty

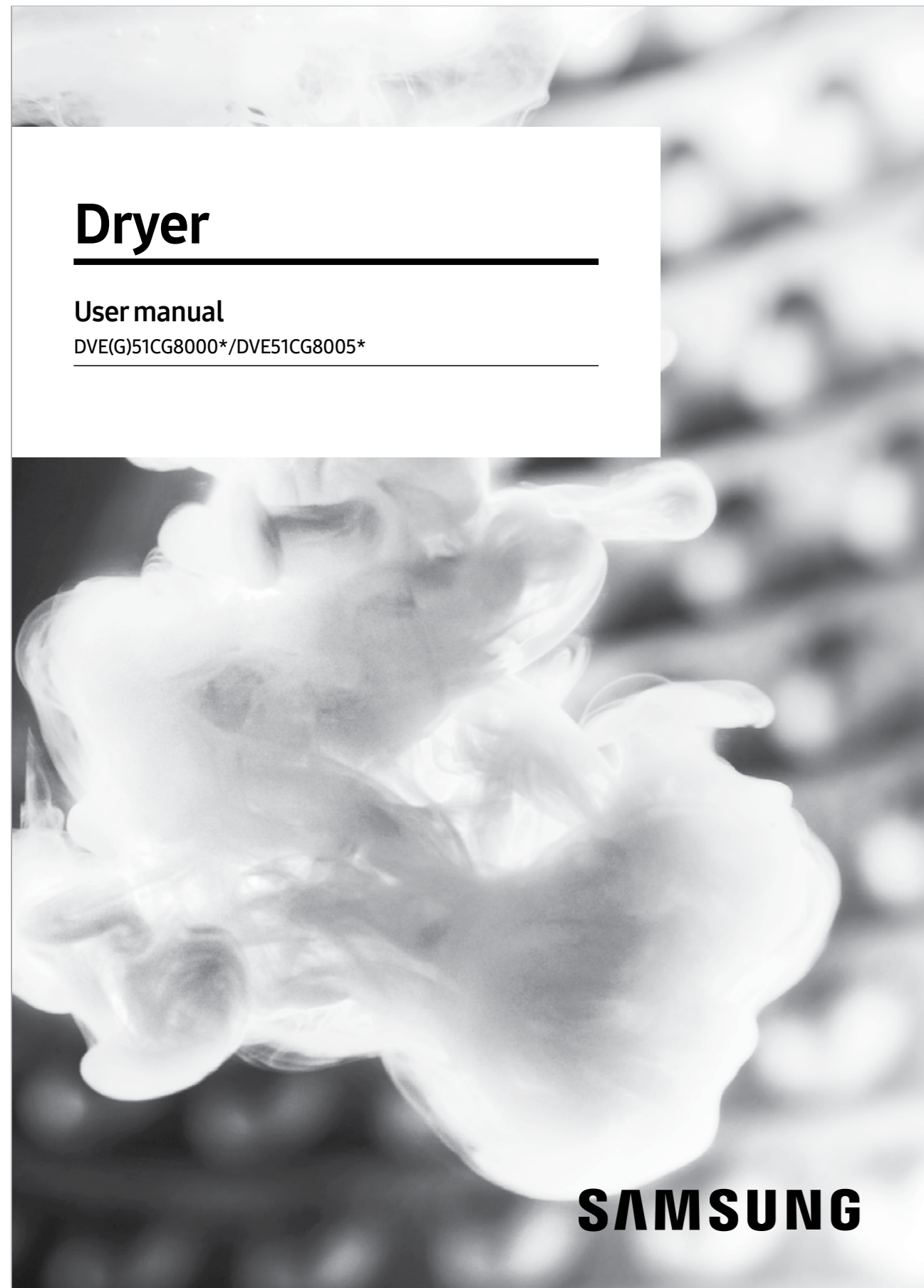

User Manual - Electric and Gas Dryers

LIMITED WARRANTY (U.S.A.) – SAMSUNG DRYER

Models:

DVE(G)51CG8000V
DVE(G)51CG8000W

LIMITED WARRANTY TO ORIGINAL PURCHASER WITH PROOF OF PURCHASE

This SAMSUNG brand product, as supplied and distributed by SAMSUNG ELECTRONICS AMERICA INC. (SAMSUNG) and delivered new, in the original carton to the original consumer purchaser, is warranted by SAMSUNG against manufacturing defects in materials or workmanship for the limited warranty period, starting from the date of original purchase, of:

One (1) Year Parts and Labor

This limited warranty is valid only on products purchased and used in the United States that have been installed, operated, and maintained according to the instructions attached to or furnished with the product. To receive warranty service, the purchaser must contact SAMSUNG at the address or phone number provided below for problem determination and service procedures. Warranty service can only be performed by a SAMSUNG authorized service center. The original dated bill of sale must be presented upon request as proof of purchase to SAMSUNG or SAMSUNG's authorized service center to receive warranty service.

SAMSUNG will provide in-home service within the contiguous United States during the warranty period at no charge, subject to availability of SAMSUNG authorized servicers within the customer's geographic area. If in-home service is not available, SAMSUNG may elect, at its option, to provide transportation of the product to and from an authorized service center. If the product is located in an area where service by a SAMSUNG authorized servicer is not available, you may be responsible for a trip charge or required to bring the product to a SAMSUNG authorized service center for service.

To receive in-home service, product must be unobstructed and accessible to the service agent.

During the applicable warranty period, a product will be repaired, replaced, or the purchase price refunded, at the sole option of SAMSUNG. SAMSUNG may use new or reconditioned parts in repairing a product, or replace the product with a new or reconditioned product. Replacement parts and products are warranted for the remaining portion of the original product's warranty or ninety (90) days, whichever is longer. All replaced parts and products are the property of SAMSUNG and you must return them to SAMSUNG.

Warranty - Electric and Gas Dryers

Feature Icons

DVE51CG8000V / DVG51CG8000V
DVE51CG8000W / DVG51CG8000W

7.5 cu. ft. Smart Electric Dryer with Sensor Dry
7.5 cu. ft. Smart Gas Dryer with Sensor Dry

Feature Icons

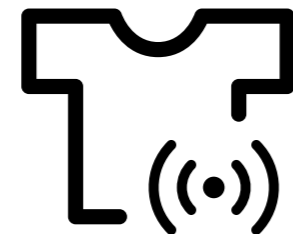

Sensor Dry

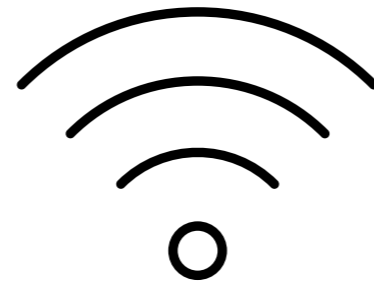

Wi-Fi Connectivity with SmartThings

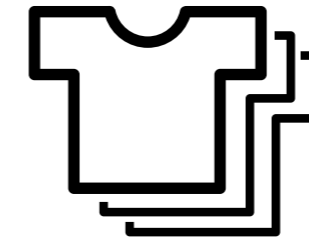

Large 7.5 cu. ft. Capacity

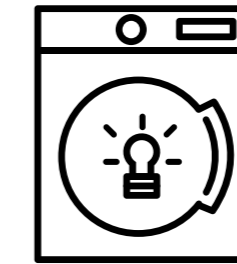

Interior Drum Light

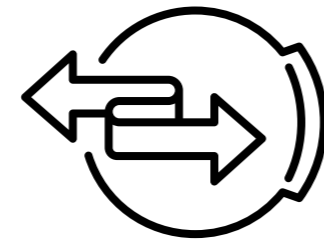

Reversible Doors

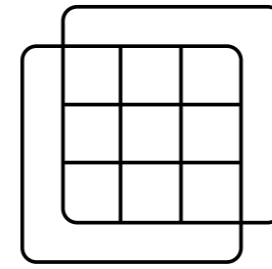

Lint Filter Indicator

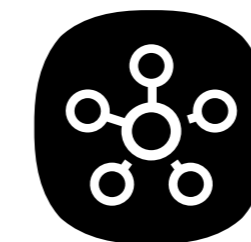

SmartThings

SAMSUNG