

FRIGIDAIRE

FFMV1846VB
FFMV1846VD
FFMV1846VS
FFMV1846VW

Over-The-Range Microwave

1.8 Cu. Ft. Over-The-Range Microwave

Available Colors : Black, Black Stainless Steel, Stainless Steel, White

Version : 08/19



Product Specifications

Controls

Add 30 Seconds	Yes
Controls	Membrane
Display Color	Green
Display Type	LED
Electronic Clock	Yes
Numeric Touch Pad	Yes
Power Levels	Yes - 10
Start Button	Yes
Stop / Cancel Button	Yes
Timer Function	99:99
Touch Pad Buttons	27

Electrical Specifications

Amps @ 120 Volts	13.5
Connected Load (kW Rating) @ 120V	1.6
Power Supply Connection Location	Right Rear Top
Voltage Rating	120V 60Hz

Auto Features

Auto Defrost Options	Yes - Weight and Time
Auto Reheat Options	Yes - 3
Baked Potato Button	Yes - 1 - 4
Auto Popcorn	Yes - Options for 1.75/3.0/3.3 oz.

Vent & Light System

Cooktop Light	LED 6 Light Module
Ducted / Ductless Vent Installation	Yes
Exhaust Fan Speeds	2 speeds - 105/300 CFM
Grease Filter (Dishwasher Safe)	2 - Yes
Lights	1
Vent Style	Hidden

Certifications & Approvals

CDRH Approval	Yes
UL/cUL Approval	Yes

User Modes

Child Lock	Yes
Clock	Yes

Exterior Dimensions

Depth	15-3/4"
Height	15-5/8"
Width	29-7/8"

Microwave Oven Specifications

Frequency (Mhz)	2450
Interior Light Wattage	LED
Microwave Turntable Diameter	12-13/32"
Watts	1000

Auto Features Specifications

Auto Melt / Soften Options	Yes - 4
----------------------------	---------

Internal Specifications

Oven Interior	White
Microwave Interior Depth	14-9/16"
Microwave Interior Height	10-9/16"
Interior Light	Yes
Microwave Interior Width	21-3/32"

General Specifications

PROP 65 Label	Yes
---------------	-----

Capacities

Capacity (Cu. Ft.)	1.8
--------------------	-----

Note: For planning purposes only. Always consult local and national electric, gas and plumbing codes. Refer to Product Installation Guide for detailed installation instructions on the web at frigidaire.com/frigidaire.ca. Specifications subject to change. Accessories information available on the web at frigidaire.com/frigidaire.ca.

FFMV1846VB
 FFMV1846VD
 FFMV1846VS
 FFMV1846VW

Over-The-Range Microwave

1.8 Cu. Ft. Over-The-Range Microwave

Available Colors : Black, Black Stainless Steel, Stainless Steel, White

Version : 08/19

Installation Drawing

Locate 120V/60Hz grounded outlet inside upper cabinet

Microwave MUST be mounted to BOTH a top cabinet† AND a wall.*

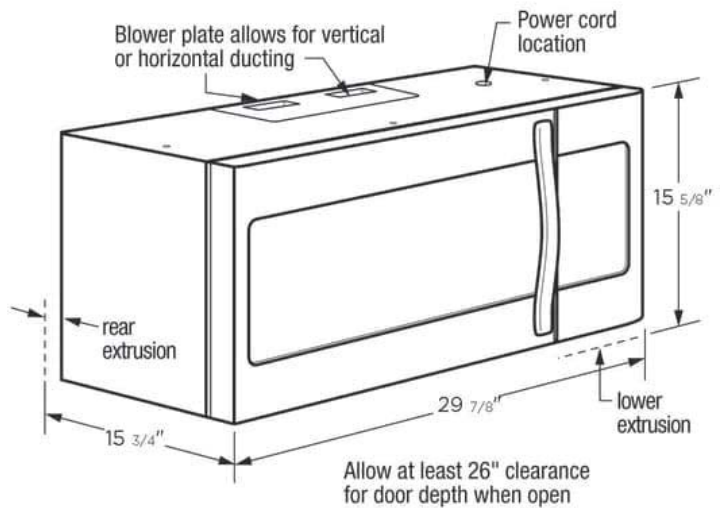
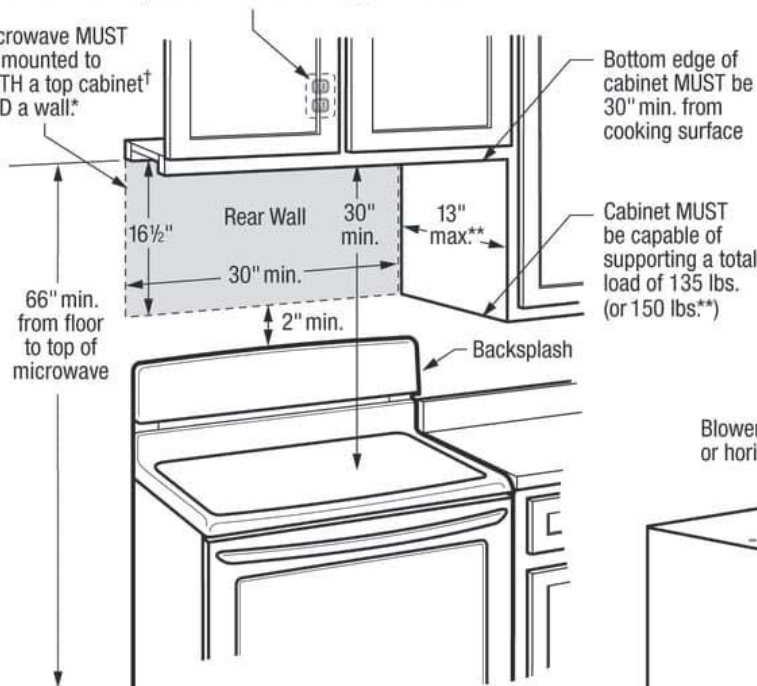

†When installing beneath smooth, flat cabinets, refer to cabinet template for detailed power cord clearance instructions

*Can NOT be installed in island or peninsula cabinet arrangements

**If cabinet depth (including doors) is deeper than 13", unit MUST be spaced out from rear wall using adequate materials (supporting 150 lbs.) to allow proper top vent air exhaust/intake

Note: For planning purposes only. Always consult local and national electric, gas and plumbing codes. Refer to Product Installation Guide for detailed installation instructions on the web at frigidaire.com/frigidaire.ca. Specifications subject to change. Accessories information available on the web at frigidaire.com/frigidaire.ca