

QUANTUM

cozzia®

USER MANUAL | CZ-800/Quantum

Hello.

Congratulations on purchasing your new Quantum.

At Cozzia we understand that every body is different and have carefully designed your massage chair with that in mind. But enough about us, this is about you. Learning how to use your new chair is simple (we designed it that way).

So let's get started.

Scan QR Code to Visit Website



Scan QR Code for Operation Video



Scan QR Code for Service Support



For replacement parts and tech support, please call our service and warranty phone number, or visit www.cozziausa.com

TABLE OF CONTENTS



INTRO

Dimensions	3
Contents	4



CHAIR

Move & Clearance	5
Components	6
Massage Points	7
Specifications	8



MASSAGE

Wired Touch-pad Interface	9-11
Try Me	12-14
Custom Program	15-20
Auto Program	21-22
Spot Program	23-24
Stretch Program	25-26
Spa Auto	27-28
Spa Manual	29-33
Chair Doctor	34-36
Heat Therapy	37-38
My Favorites	39-40
Recline	41-42
Settings	43-52
User Account	53-56

TABLE OF CONTENTS



CARE

Safety	57-58
Grounding Instruction	59
Troubleshooting	59
Care and Storage	59
Warranty	60

DIMENSIONS

First, let's get your chair inside.

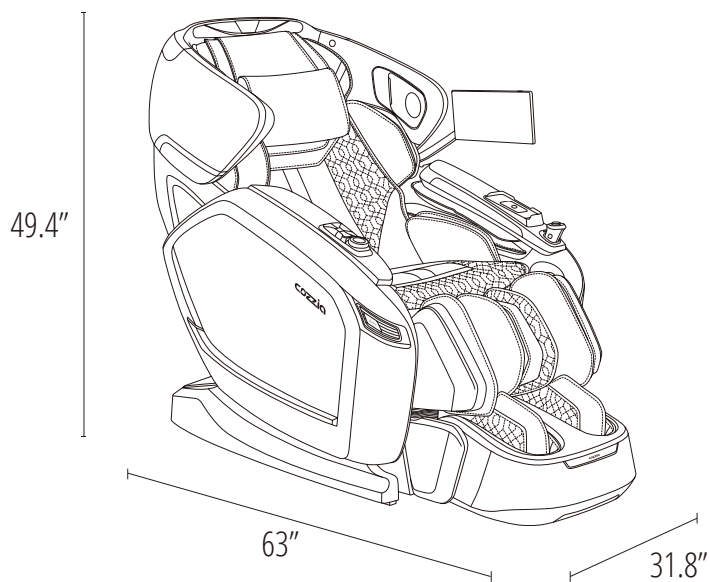

Box 1

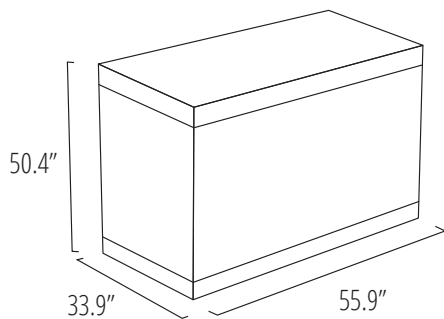

Base & Backrest

Box 2

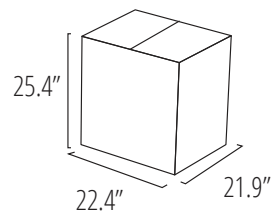

Footrest

CONTENTS

Everything you need for a relaxing experience.

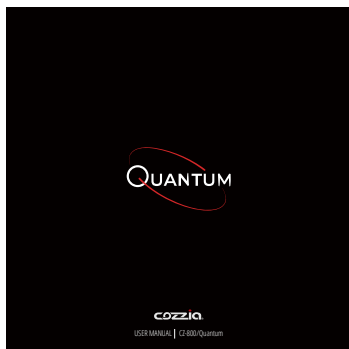

User Manual

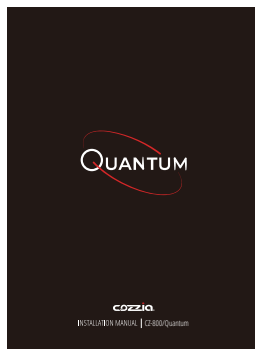

Installation Manual



Warranty Postcard

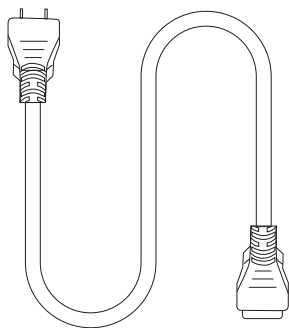

Power Cord

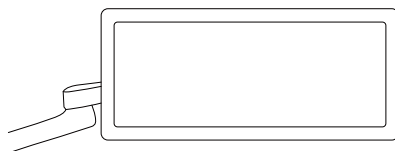

Widescreen Touch-Pad

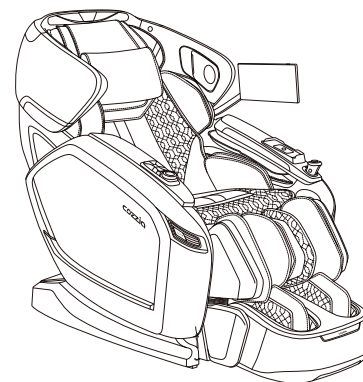

CZ-800/Quantum Massage chair

Move & Clearance

A few simple steps to find the best place for your new chair.

HOW TO MOVE

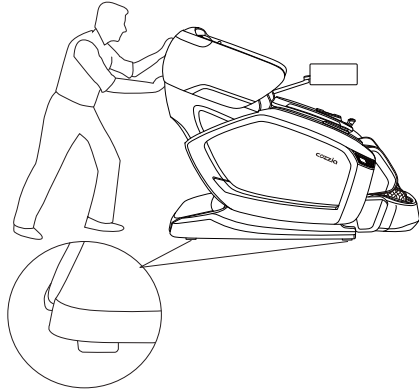

Move with a slight pull or push
Caution: If you roll the chair on wood floor, marks may be left

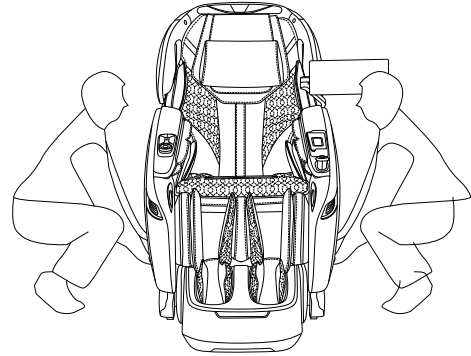

Two people are needed to lift the chair

CLEARANCE

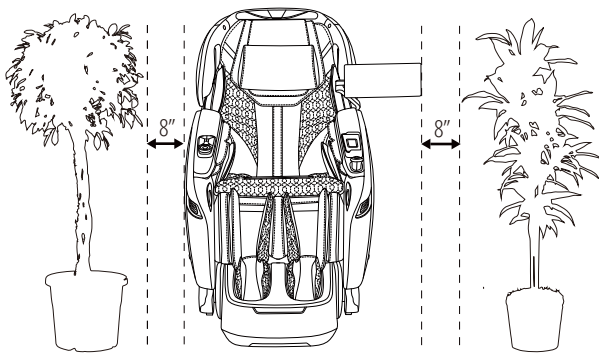

Reserve space on the left and right

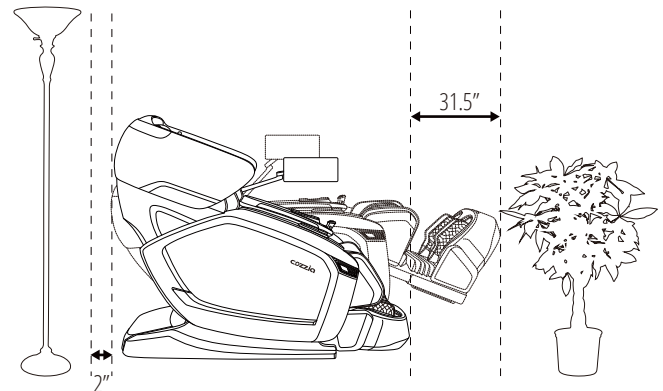

Reserve space on the front and back

CHAIR COMPONENTS

Some of your chair's most important features.

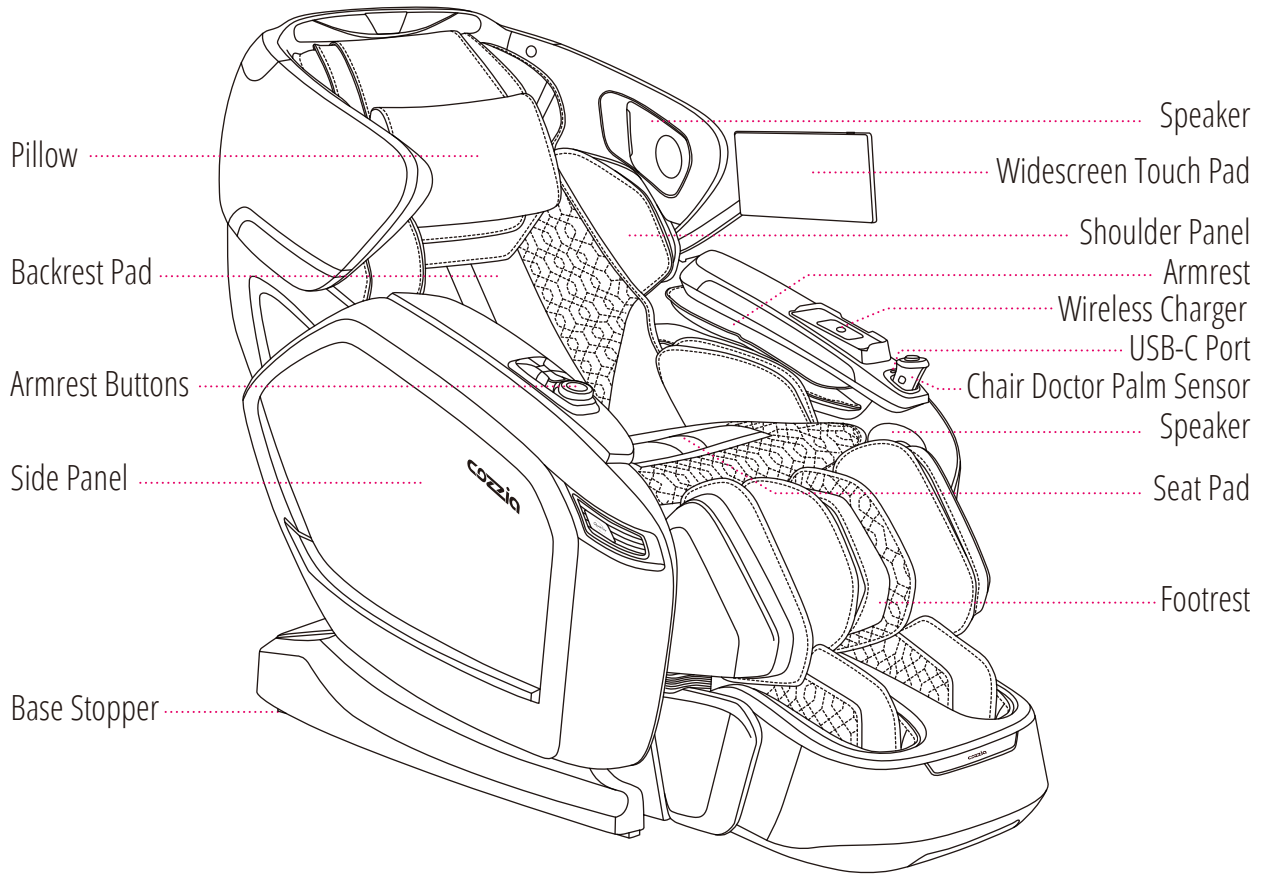

Note: The speaker will only operate when the massage chair is in operation



To play music using your massage chair's speakers please connect your smartphone, tablet, or other electronic device to your chair using bluetooth. Note that the code to connect the bluetooth is Cozzia Quantum.

MASSAGE POINTS

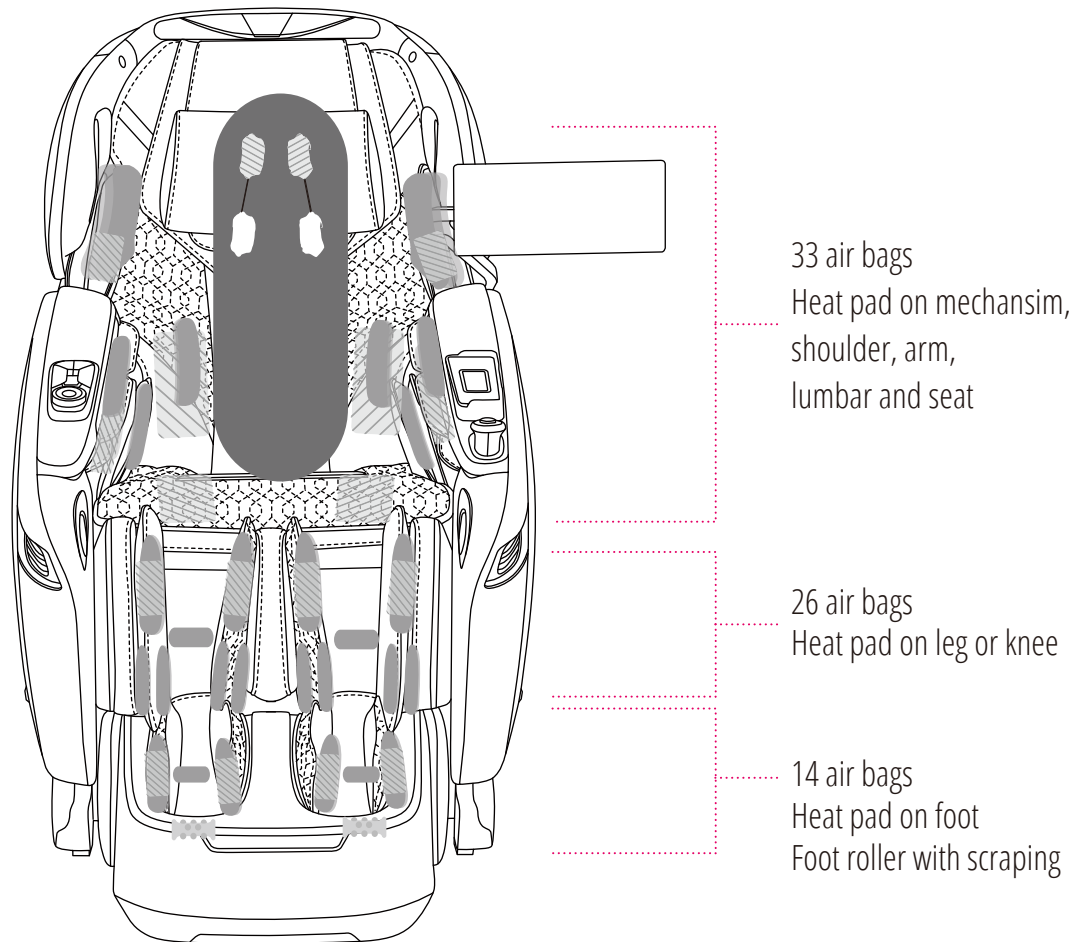

●
Back Massage Mode

●
Air Bag

▨
Heater

▩
Roller

CHAIR SPECIFICATIONS

A few important facts about your massage chair.



Model No.
CZ-800/ Quantum



Massage Time
5 to 30 Minutes

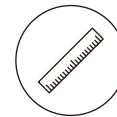

Dimensions (L x W x H)
Chair dimensions: 63" x 31.8" x 49.4"
Reclined dimensions: 74.4" x 31.8" x 40.4"



Shipping Weight
Gross weight: 334.9 lbs
Net weight: 293.6 lbs



Usage Condition
Environment temperature: 10°C-40°C
Contrasting humidity: 30-85RH

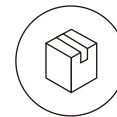

Storage Condition
Storage temperature: -20°C-60°C
Storage humidity level: 30-85RH



Rated Current
2.3A



Rated Voltage
110 - 120V



Rated Frequency
60Hz



Power of Monster Speakers
15x2W & 8x2W

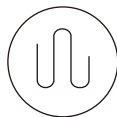

Length of Wiring
Power supply wiring: 70.9"



Safety Feature
Equipped with child safety lock,
leg rest safety sensor,
and overheating and power surge detectors

WIRED TOUCH-PAD INTERFACE

We have designed your massage chair's tablet controller with a user-friendly interface to make using your chair even easier.

Home Screen 1

Date

Chair Doctor

User Accounts

Go to Massage Page



Power

Recline

Mood Light

Foot Rollers

Negative Ions

Volume

Settings

Heat Therapy

My Favorites

Home Screen 2

Auto Program

Stretch Program

Spa Auto

Spa Manual

Try Me



Recommended Massage Program

Spot Program

Custom Program

Custom Spa Program

Custom Spa Auto Program

Massage Controls

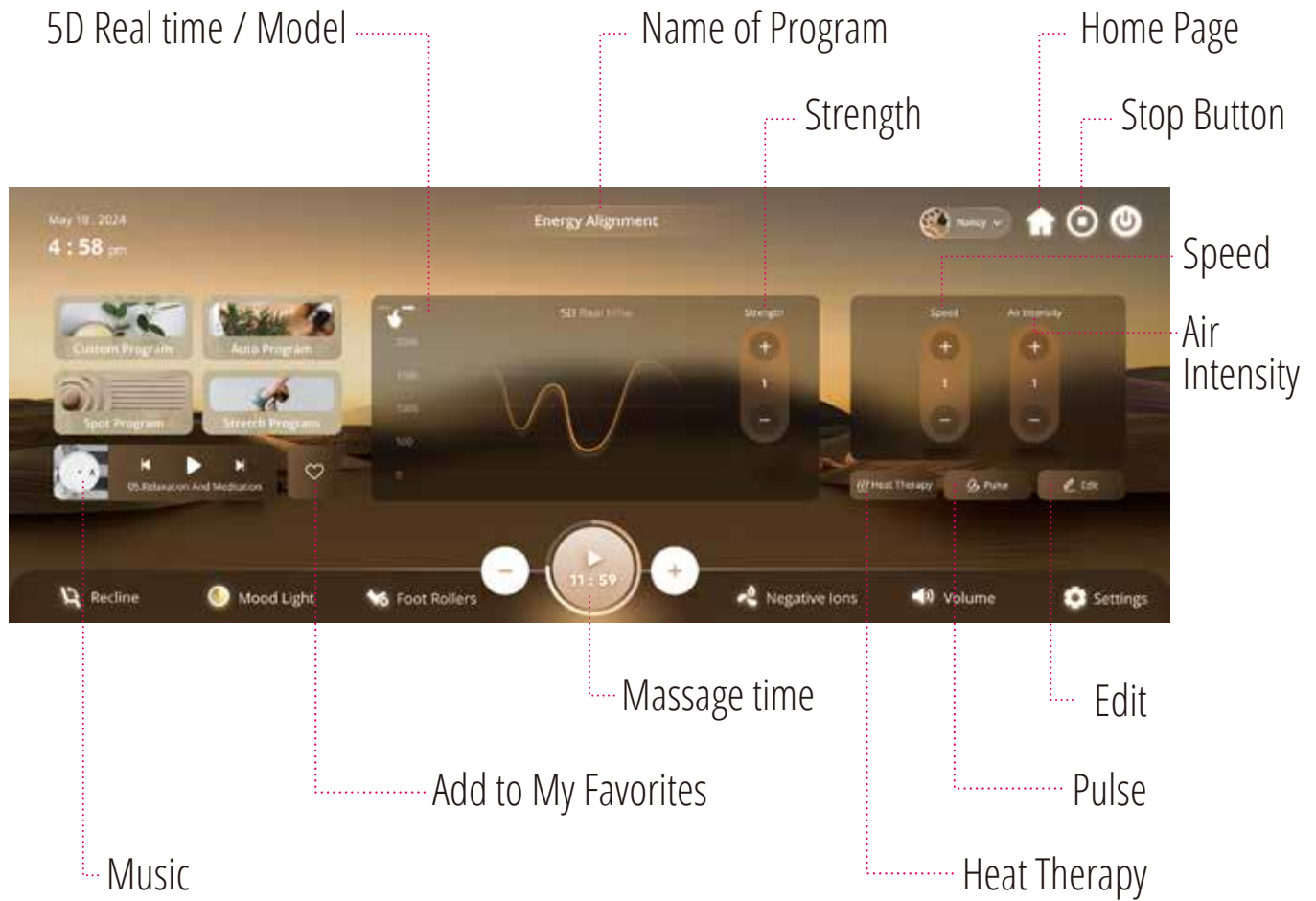

TRY ME

In order to allow you to quickly understand the many features of this massage chair, we have created a Try Me program for you.



Choose the "Try Me" icon to begin the Try Me program

Try Me Interface 1



Shoulder Scan Confirmation Page

Try Me Interface 2

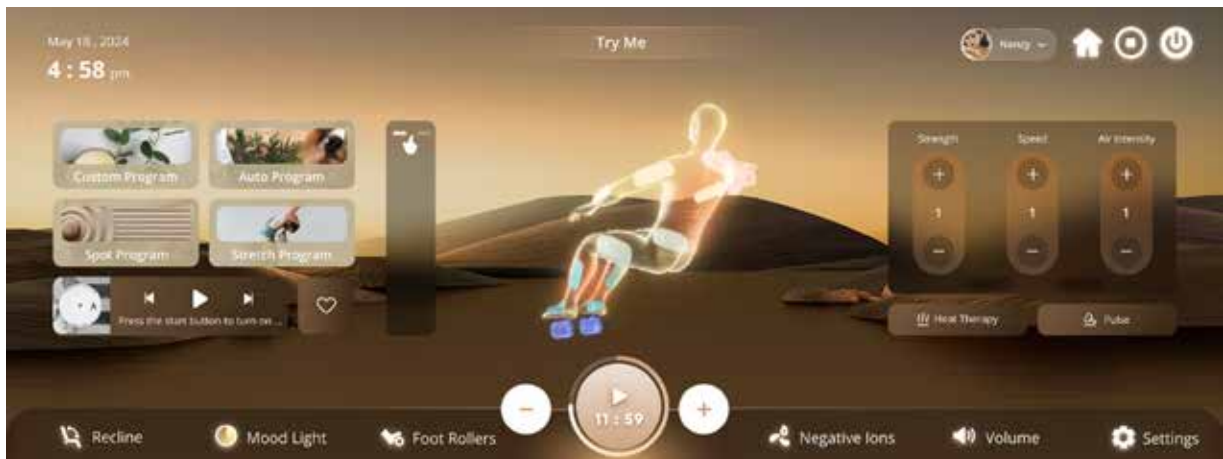

CUSTOM PROGRAM

Every body is different. That's why we've given you the option to customize your massage to meet your specific needs. Follow these simple instructions to create a new custom massage.



Custom Program Interface 1

Message

Message Action



Message Strength

Switch upper and lower body

Select the massage areas, massage action and massage strength that you prefer

Custom Program Interface 2

Airbags

Massage Action



Select the airbags massage areas that you prefer

Custom Program Interface 3

Heat

Temperature

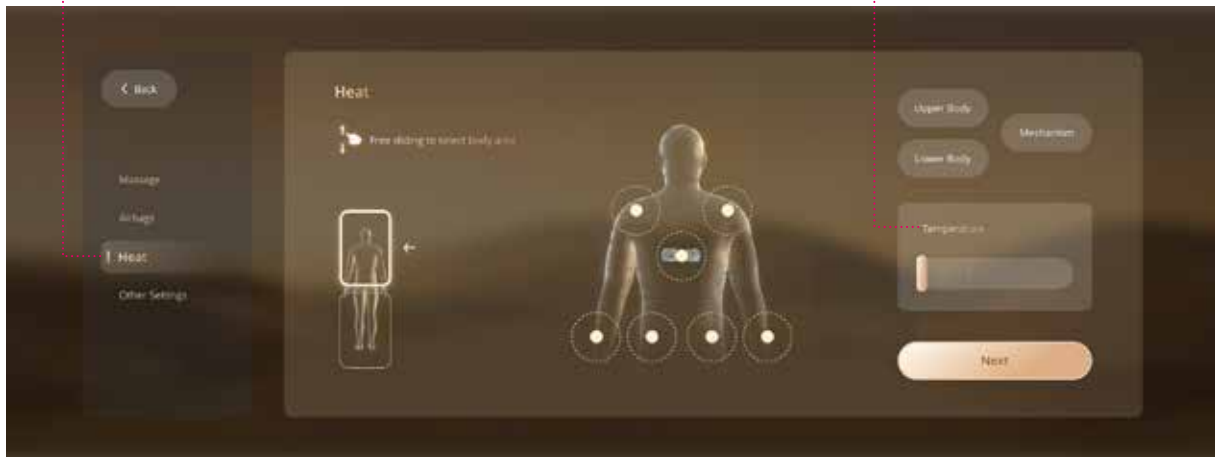

Select the heat areas and temperature that you prefer

Custom Program Interface 4

Light Color

Negative Ions Switch

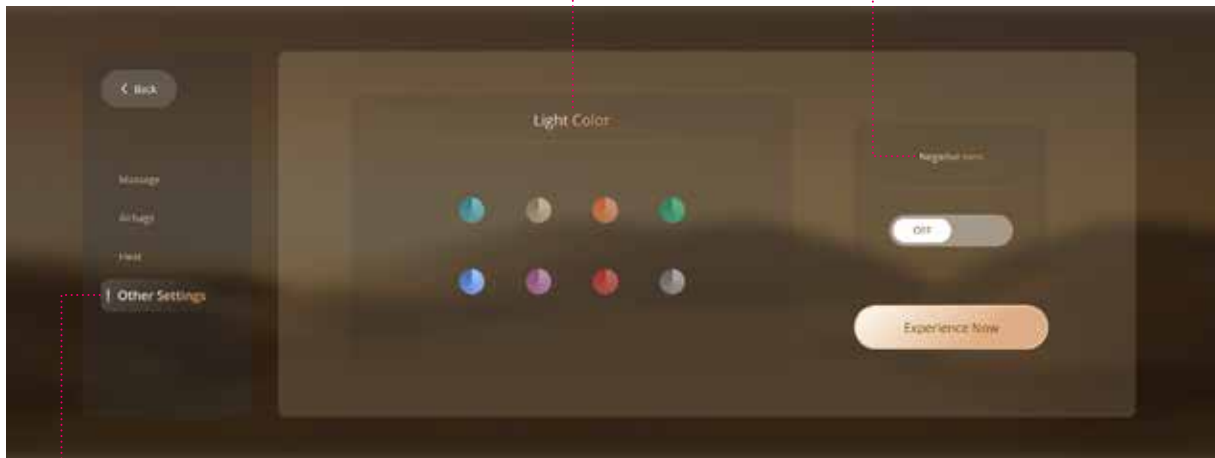

Other Settings

Select the light color and negative ions that you prefer

Custom Program Interface 5



After creating your custom program, you can click on the "Favorites" icon to create your own custom program name and save it to your favorites

AUTO PROGRAM

We have designed your chair with multiple massage options for your changing needs. Follow these simple instructions to begin a new auto massage.



Choose the "Auto Program" icon to select your auto massage program

Auto program Interface

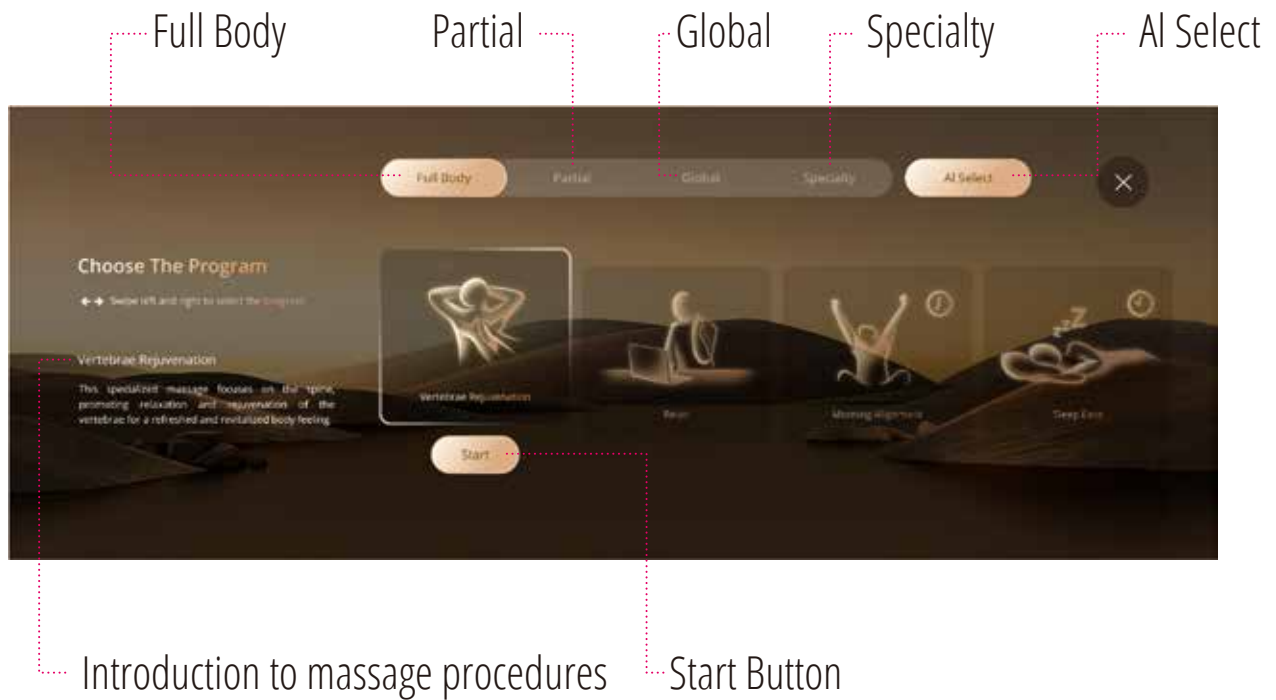

You can choose your favorite massage program icon and press the "Start" button to begin the massage, or you can click the "AI Select" button to randomly start a program

SPOT PROGRAM

This is a fixed message area and actions program.



Choose the "Spot Program" button to take you to the spot massage page

Spot Program Interface

Airbag

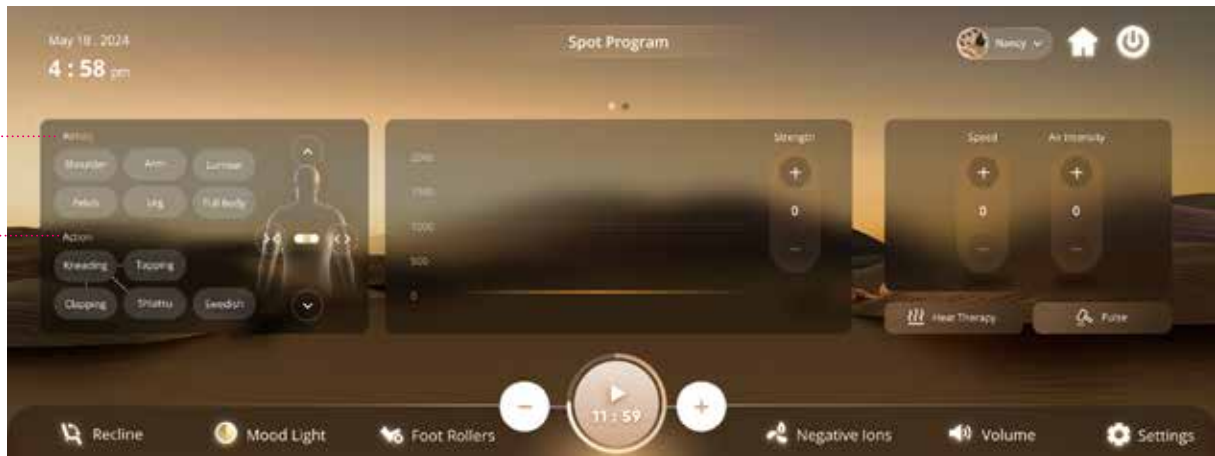

Action

STRETCH PROGRAM

Every body is different. That's why we've given you the option to customize your stretch massage to meet your specific needs. Please select the area where you need to stretch.



Stretch Program Interface

Stretch Area

Temperature

Heat Switch



Start Button

Select the stretch areas and temperature that you prefer

SPA AUTO

Experience the ultimate relaxation with SPA auto massage chair's preset programs, designed to soothe your body and mind with a seamless blend of massage techniques tailored for your ultimate comfort.



Spa Auto Interface

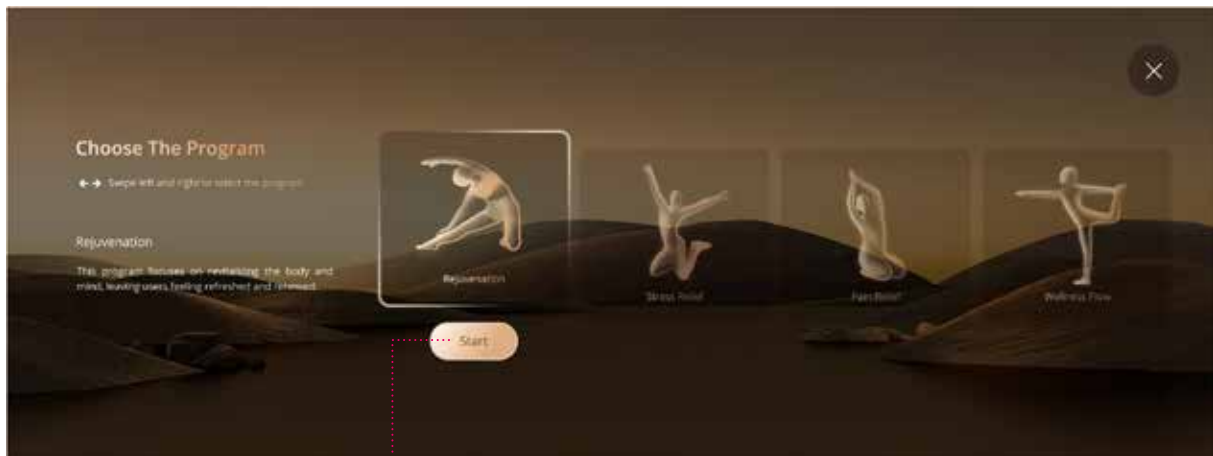

Start Button

Rejuvenation / Stress Relief / Pain Relief / Wellness Flow / Ultimate Relaxation

SPA MANUAL

Elevate your massage experience with SPA manual massage chair's flexible customization options. Design your own perfect massage routine, blending different massage styles and techniques to create a one-of-a-kind therapy session.



Choose the "Spa Manual" icon to custom your Spa manual massage

Spa Manual Interface 1

Preset Program

Massage Time

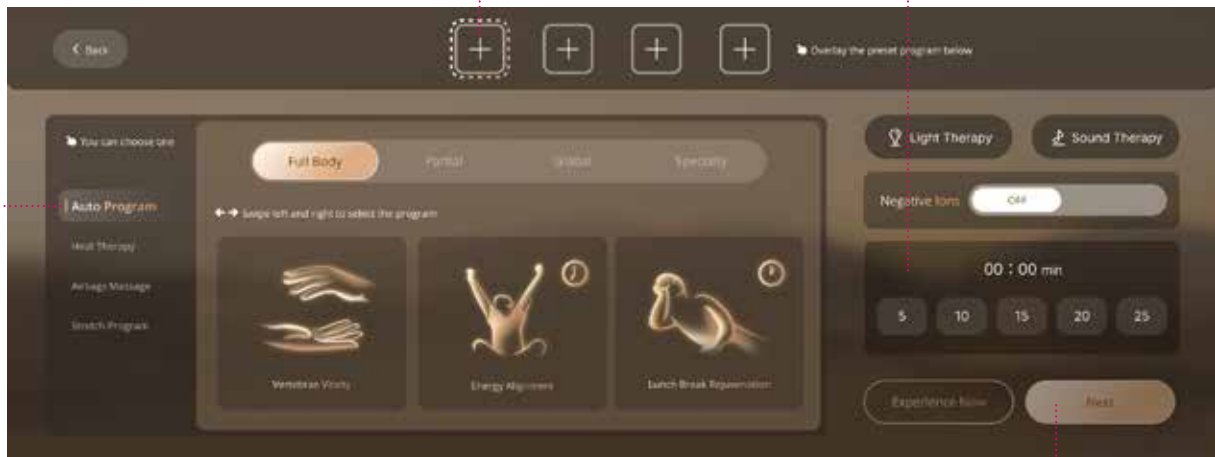

Auto Program

Next Button

Choose the auto program you prefer

Spa Manual Interface 2

Heat Area

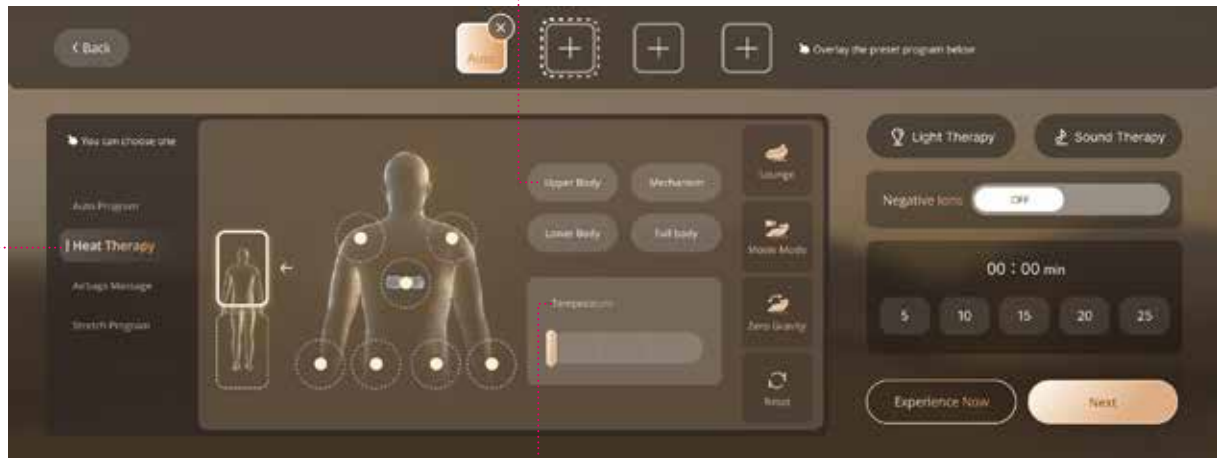

Heat Therapy

Heat Temperature

Choose the heat area,temperature and time you prefer

Spa Manual Interface 3

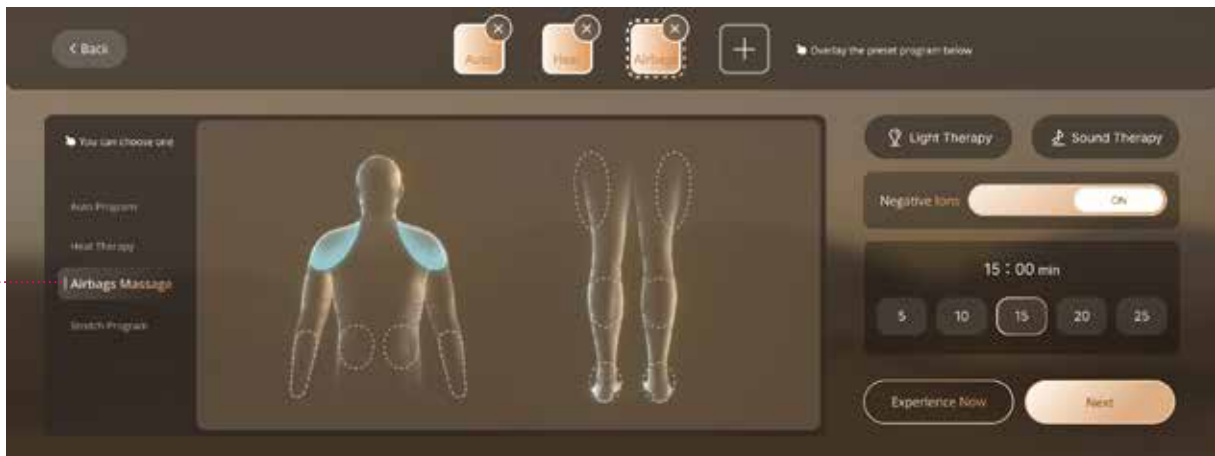

Airbags Massage

Choose the airbags massage area and massage time you prefer

Spa Manual Interface 4



Stretch Program

Start Button

Choose the stretch program you prefer, one or more stretching programs are available

CHAIR DOCTOR

An innovative tool that diagnoses your body tension, SpO2 (oxygen saturation), and heart rate etc, to customize a treatment for your unique body.



Chair Doctor Interface 1

Historical Health Data

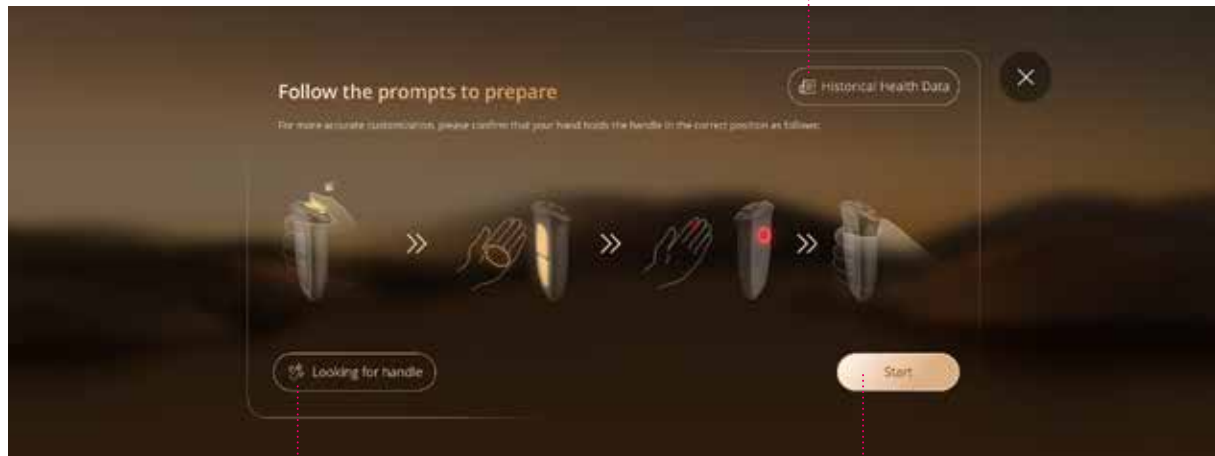

Looking For Handle

Start Button

Chair Doctor Interface 2

Score

User Information

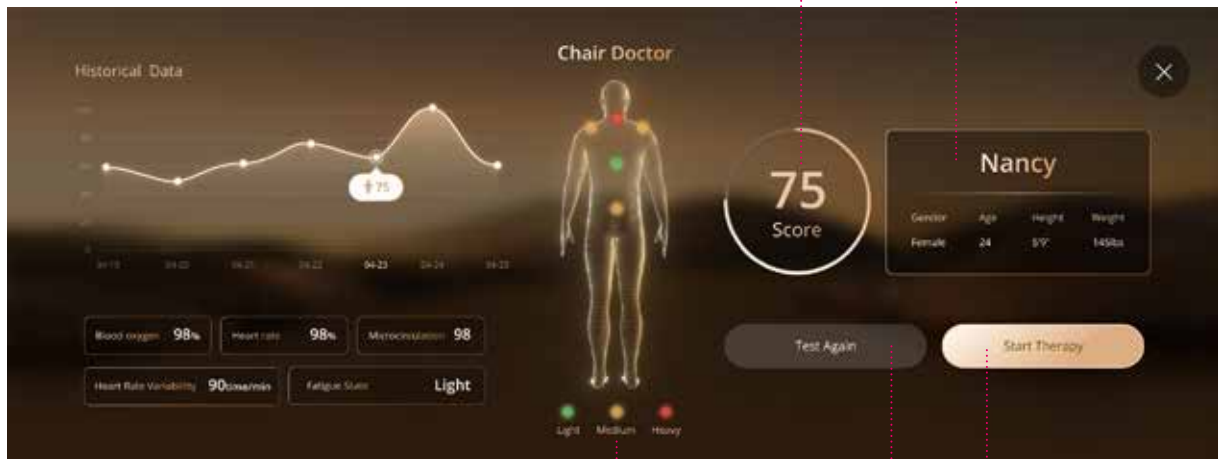

Human body Fatigue State

Test Again

Start Therapy

HEAT THERAPY

Multi-zone heating with adjustable temperature settings for personalized comfort.



Heat Therapy Interface



MY FAVORITES

Discover your Massage program Favorites – a quick-access collection of your top massage program picks for instant relaxation.



My Favorites Interface 1



Edit Home Page
recommended program

Edit my
favorites program

RECLINE



Recline Interface



Press and hold to adjust seat position

SETTINGS

Choose the “Settings” icon to take you to the settings page.



Settings Interface

Bluetooth Settings

Touch Sound

WiFi Settings

Child Lock

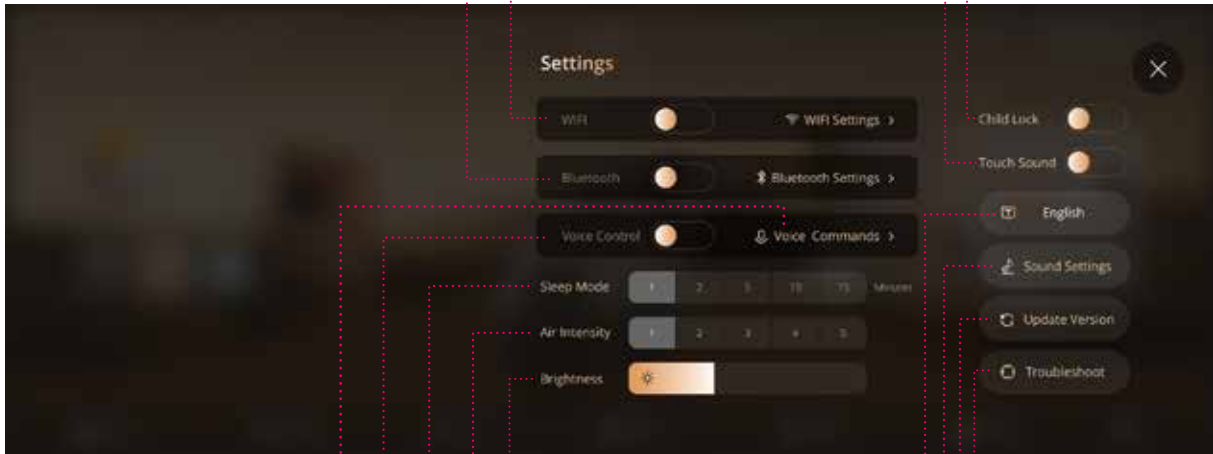

Brighness

Troubleshoot

Air Intensity

Update Version

Sleep Mode

Sound Settings

Voice Control Switch

Language

Voice Commands

Child Lock



To disable this chair for child safety, turn on the child lock switch

Child Lock 1



Set a password and click the confirm button
When the child safety lock is on, the massage chair will be turned off and reset - all functions will be disabled

Child Lock 2

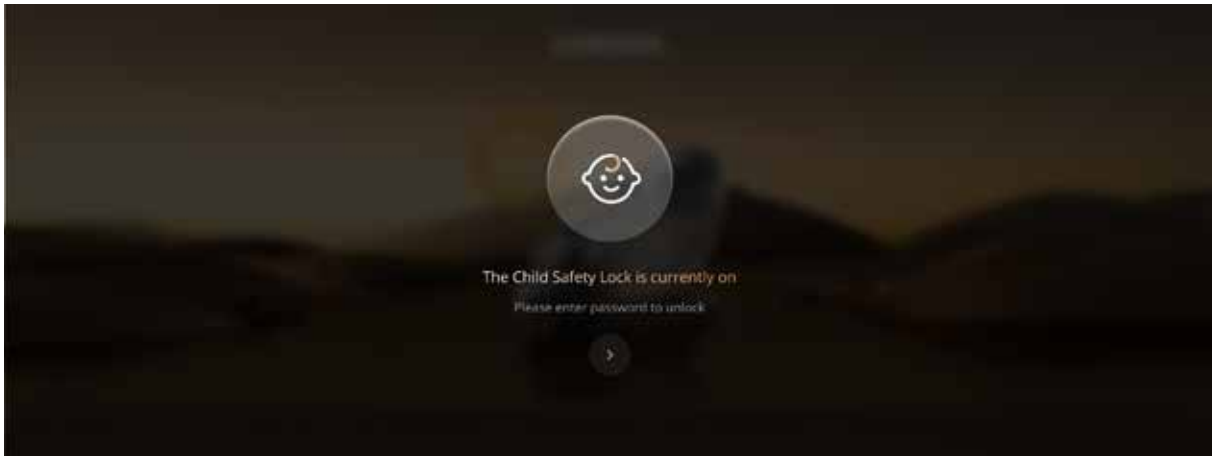

When the child safety lock is enabled, this screen will appear at startup

Child Lock 3



Please enter the password you set or "0304" to unlock your massage chair
If you don't need the Child Safety Lock on anymore, go to the Settings page to turn off this function

Trouble Shooting Interface

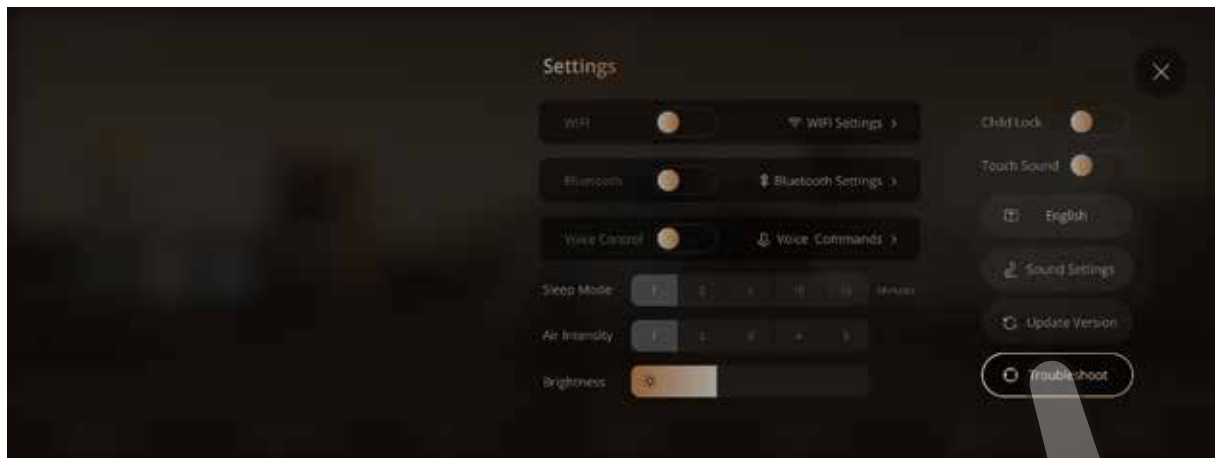

If your chair has any trouble, press the "Trouble Shoot" icon for the chair to automatically detect problem areas Use the error code provided when contacting our customer service team

Trouble Shooting Interface 1



Choose "Start" icon and make sure the chair is not occupied during chair detection

Trouble Shooting Interface 2



Your chair is detecting possible malfunctions, please wait for the detection result

Trouble Shooting Interface 3



You can use your detection code when contacting the customer service team about your chair's problems

USER ACCOUNT



Choose the “User Account” icon to get to the account settings page
*A wifi connection is required before logging in to your account
After logging in to your account, you can save your own favorite programs and health data

Register an Account Interface



Enter your email address and click the "Code" button to get a verification code sent to your email
Enter the verification code from your email, then create your password
Before registering an account, you need to agree to the service agreement and privacy policy

Account login Interface



If you already have an account, you can log in with your password or email verification code

Account Settings Interface

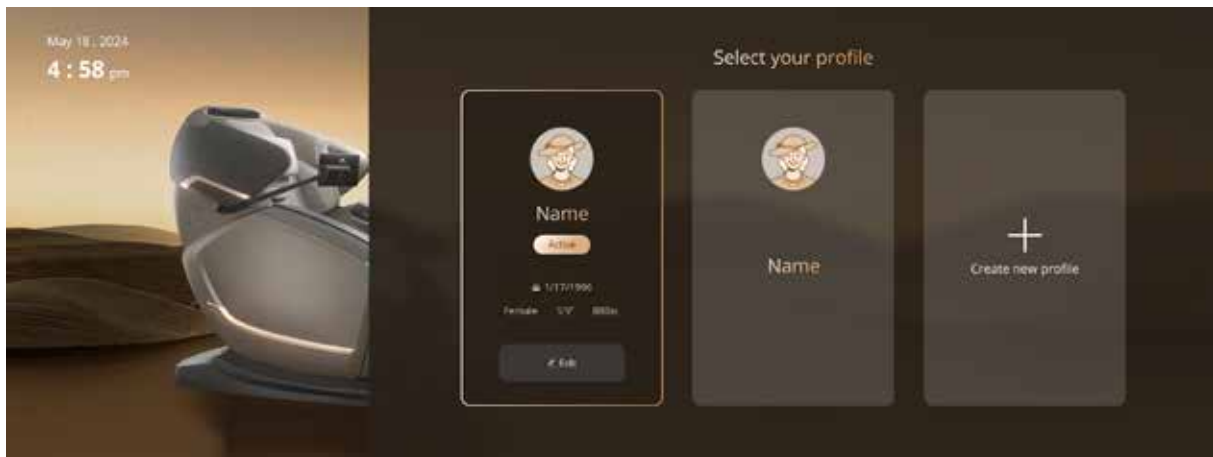

You can switch between accounts or edit your account information

SAFETY PRECAUTIONS

We're looking out for you.

IMPORTANT SAFETY INSTRUCTIONS

When using the massage chair, basic precautions should always be followed, including the following:
Read all instructions before using this massage chair.

DANGER - To reduce the risk of electric shock:

- Always unplug this massage chair from the electrical outlet immediately after using and before cleaning.
- Never use pins or other metallic fasteners with this appliance.
- Carefully examine the covering before each use. Call for service if the covering shows any sign of deterioration, such as blistering, peeling or cracking.
- Keep dry - do not operate in a wet or moist condition.

WARNING - To reduce the risks of burns, fire, electric shock or injury to persons:

- Read all instructions before using.
- A massage chair should never be left unattended when plugged in. Unplug from the outlet when it is not in use and before putting on or taking off parts.
- Close supervision is necessary when this massage chair is used by or near children or disabled persons. Keep children away from reclining backrest and extended leg rest.
- Use this massage chair only for its intended use as described in this manual.
- Never operate this massage chair if it has a damaged cord or plug, if it is not working properly, if it has been dropped or damaged, or dropped into water. Contact customer service department.
- Keep the cord away from heated surfaces.
- Never operate the massage chair with the air openings blocked. Keep the air openings free of lint, hair and the like.
- Never drop or insert any object into any opening.
- Do not use outdoors.
- Do not operate where aerosol (spray) products are being used or where oxygen is being administered.
- To disconnect, turn all controls to the off position, then remove the plug from the outlet.
- Do not stand on or in the massage chair. Use only while seated.
- The product is not intended for use by children or persons with reduced physical, sensory or mental capabilities, or lack of experience and knowledge, unless they have been given supervision or instruction concerning use of the product by a person responsible for their safety.
- Children should be supervised to ensure that they do not play with the product.
- Temperatures sufficiently high to cause burns may occur regardless of the control setting. Do not use on an infant or invalid or on a sleeping or unconscious person. Check the skin in contact with the heated area of the appliance frequently to reduce the risk of blistering.
- Burns may result from improper use.
- Do not crush in order to avoid sharp folds.
- Keep children away from extended foot support (or other similar parts).

- DO NOT WET.
- DO NOT USE PINS.
- NEVER REMOVE COVER.
- Connect this appliance to a properly grounded outlet only. See Grounding Instructions.

SAVE THESE INSTRUCTIONS

This massage chair is intended for household use only.

1. Usage Environment

- Do not use the massage chair in an excessively humid or dusty environment as this may result in malfunction or electric shock.
- Do not use the massage chair in a room with a temperature of 104°F or higher.
- Do not expose the massage chair to heaters, stoves or direct sunlight.
- Place and use the massage chair on an even, non-slip floor.
- The massage chair is designed for home use and not for commercial purposes.



Caution

- This massage chair is to be used indoors only.
- If you use the massage chair in a cold room, do not increase the room temperature abruptly. It is recommended that you increase the temperature gradually to a normal level.
- If the massage chair is stored in a cold place and is being brought into a warm environment, it is advisable to wait for one hour before use. This is because its performance may not be at an optimal level, as there may be water droplets on the mechanical parts due to condensation. Using the massage chair under such conditions may result in malfunction.

2. Safety Precautions

- To ensure safe and correct use of the massage chair, do not operate it without reading this operation manual carefully.
- Do not use the massage chair when the upholstery or seat is removed. This may cause injury or malfunction.
- Do not use the massage chair in combination with other therapeutic equipment or electric blanket etc., as this may result in ineffectiveness or injury.
- Do not use the massage chair an hour before or after eating as this may have adverse effects on the user.
- Do not allow children or pets to play around the massage chair, e.g. behind the backrest, under the seat base or legrest of the massage chair. This may result in injury.
- Do not use the massage chair when your body is wet.
- Do not operate the massage chair with wet hands.
- It is not recommended to use the massage chair for more than 30 minutes.
- Do not perform continuous massage on the same spot of your body for more than 5 minutes at a time as this may result in excessive stimulation and may have adverse effects.
- Do not insert your hand or foot along the paths of the massage rollers during use as this may cause injury.
- Stop operation immediately if you feel any discomfort.
- This product is not intended for self-treatment of conditions that should be managed by a qualified health care provider.
- People on medication or with medical conditions, please consult your doctor before use.
- Please do not use the product if you are not feeling well.

3. People with Medical Conditions

Consult your doctor before use if you:

- Are under medical rest as ordered by a doctor.
- Have spinal disorders, an abnormal spinal condition or have suffered a spinal injury.
- Have back problems.
- Have diabetes, osteoporosis or sensory impairment.
- Have joint dysfunction such as rheumatism, hammertoe or gout.
- Have a pacemaker or other electronic medical devices.
- May be pregnant.
- Have phlebitis or thrombosis.
- Have an increased risk for blood clots.
- Had recent surgery.
- Have surgical pins, screws, or anything mechanical in the legs, ankles or feet.



Caution

- Avoid using the massage chair under the influence of alcohol.
- Do not apply massage rollers directly on the head, elbow or knee joints, torso or abdomen.
- If your legs or feet slip off the leg rest during massage, do not force them back in as this may result in injury.
- Remove the power plug from the electrical outlet immediately should liquid be accidentally spilled onto the massage chair. Do not use wet hands to connect or disconnect the power plug from the electrical outlet.
- Do not tamper with the power cord or use the massage chair with a damaged cord as this may result in malfunction and electric shock.

4. Instances When the Massage Chair Should Not Be Used

In the following events, please switch off the main power switch immediately and disconnect the power cord from the electrical outlet:

- If liquid is accidentally spilled onto the massage chair. This may result in electric shock or malfunction.
- If the fabric of the backrest is torn and the internal components are exposed.
- If pain or discomfort is felt during massage, stop operation immediately and consult your doctor.
- If you detect any malfunction or any other abnormal condition during operation.
- If there is power failure. Injury may occur when power is restored unexpectedly.
- If there is lightning.

5. Assembly and Repair of the Massage Chair

- Do not disassemble the backrest cover of the massage chair. Touching the internal components may result in malfunction or electrical shock.
- This massage chair must only be professionally serviced or repaired. Only disassemble or repair the massage chair if directed by a Cozzia service rep.

6. Things to Be Noted About the Power Plug and Cord

- Check that the Alternating Current (AC) voltage corresponds with the specifications indicated for the massage chair.
- Do not connect or disconnect the power plug from the electrical outlet with wet hands. This may result in malfunction or electric shock.
- When disconnecting the power plug, pull it by holding the plug, not the cord.
- Although operation will be stopped automatically by the Auto-Timer function, always remember to switch off the main power after use.
- Do not place the power cord under the massage chair or under any other heavy objects.
- Do not wind the power cord around the massage chair as this may damage the cord and result in a fire or electric shock.
- Do not operate the massage chair with a damaged cord or extension cord.
- Do not use the massage chair if the electrical outlet is loose.
- If the power cord is damaged, it should be replaced by a qualified technician.

GROUNDING INSTRUCTIONS

This product must be grounded. If it should malfunction or break down, grounding provides a path of least resistance for the electric current to reduce the risk of electric shock. This product is equipped with a cord that has an equipment-grounding conductor and a grounding plug. The plug must be plugged into an appropriate outlet that is properly installed and grounded in accordance with all local codes and ordinances.

Danger - Improper connection of the equipment-grounding conductor can result in a risk of electric shock. Check with a qualified electrician or service technician if it will not fit the outlet. Have a proper outlet installed by a qualified electrician.

This product is for use on a nominal 120V circuit and has a grounding plug that looks like that plug illustrated below. Make sure that the product is connected to an outlet having the same configuration as the plug. No adapter should be used with this product.

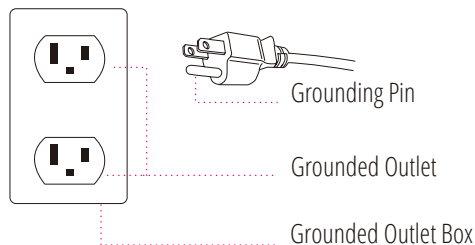

TROUBLESHOOTING

This massage chair is controlled by a microcomputer and is thus susceptible to power surges of +10 to -15%. The following situations may arise in the event of a power surge:

Situation	Solution
The massage chair is connected to the power supply but is not functioning	1. Check to see that the plug is properly connected and working 2. Ensure the massage chair switch is in the 'I' position
The remote control works but the massage chair is not functioning	Possible overheating due to prolonged use. Turn off the power for at least 30 to 50 minutes
Both the remote control and the massage chair are not functioning	1. Ensure the chair is plugged into a working outlet 2. Turn the power OFF and ON again

If you continue to have problems, please read the warranty card and contact the Cozia service department.

PRODUCT CARE AND STORAGE

1. Storing the Massage Chair

- Wipe off dust and dirt from the massage chair with a dry, soft, clean cloth after use.
- Keep the massage chair clean and away from places of high humidity.
- If the massage chair is not to be used for a long period of time, cover the massage chair with a dust cover and unplug its power plug from the electrical outlet.

⚠ Caution

- Do not store the massage chair in direct sunlight or in places of high temperature. This may cause the color of the upholstery to fade.
- Do not allow the massage chair to remain in contact with vinyl or wallpaper for extended periods of time as this could lead to discoloration.

2. Cleaning the Massage Chair

- Before cleaning, ensure that the main power switch is off and the power plug is disconnected from the electrical outlet.
- Wipe off dust and dirt from the massage chair with a dry, soft, clean cloth after each use.
- This product can be cleaned thoroughly with a slightly damp cloth.
- Do not iron the upholstery.
- Do not wash the upholstery using a home washing machine as this may result in deterioration of the upholstery's quality.

⚠ Caution

- Do not use abrasive cleaning agents like benzene or thinner to clean the massage chair. This may cause the upholstery to fade.

3. Cleaning the Controller

- Use only a clean, dry cloth to clean the controller.

⚠ Caution

- Do not use a wet cloth to clean the controller. This may result in malfunction.

COZZIA CONSUMER WARRANTY

This Cozzia product has the following warranty:

The Cozzia Quantum has a three-year in-home service and parts warranty. Cozzia customer service will not issue Return Material Authorizations (RMAs) for products. Cozzia products will be either repaired by the consumer or by an in-home technician. Cozzia will not issue Return Material Authorizations (RMAs) for buyer's remorse.

Service And Technical Support

Consumers may contact Cozzia's customer service department at 1-877-977-0656 between 9:00 am and 5:30 pm PST, Monday through Friday, email us at Service@cozziausa.com, or visit our website at www.cozziausa.com for warranty or service issues.

Consumers are required to provide the unit serial number and dated proof of purchase (sales receipt) when they contact the Cozzia service department regarding a repair.

A Cozzia customer service representative will attend to most consumer inquiries, but in some cases a technical service specialist will provide advanced support.

Non-warranty repair is provided on a "per incident" basis. Cozzia customer service will verify that the unit has failed and provide instructions for repairing the unit. All applicable repairs, parts, shipping, handling, local tax and a "per incident" fee will be charged for non-warranty repairs and support calls.

Proof of purchase (original receipt) is required for all warranty repairs or service.

Extended Warranties:

Cozzia offers extended warranty programs to enhance the ownership of your massage chair. Please call Cozzia customer service at 877-977-0656 for details and pricing.

Product Repairs

- Floor Models and Demonstration Units have a prorated warranty period that begins the day the model is placed on the floor and connected to an electrical outlet by the retail partner. Proof of purchase is required in order to obtain warranty service and parts. Non-warranty parts and service are available at a "per incident" charge.
- Warranty Coverage Period - Warranty coverage starts at the time that the consumer PURCHASES their chair. Proof of purchase is required for all warranty repairs. The warranty time period is measured by continuous calendar days based on a seven-day week.
- Field Service - Cozzia customer service department will diagnose and schedule an authorized service provider to repair the chair in the consumer's residence.

- Parts - All parts deemed necessary for repairs will be shipped to the consumer at no charge by the Cozzia service department. Some Cozzia product repairs may be performed by the consumer in their own home with parts and instructions supplied by Cozzia, such as remote controller replacements that don't require a technician.

CONSUMER WARRANTY LIMITATIONS AND EXCLUSIONS

- Warranties are only valid in the 48 contiguous United States and Canada and are contingent upon the consumer operating the chair according to the corresponding instruction manual.
 - The warranty only applies to Cozzia products and does not include any accessories or enhancements.
 - Field service requires pre-approval and must be performed by Cozzia's authorized field service personnel.
 - Field service is only available in the United States and in major metropolitan areas in Canada.
 - Softening of foams and filling composites in pillows, pads, and memory foam occurs naturally and does not constitute a defect under this warranty.
 - Fading, wear and piling of fabrics occurs naturally and does not constitute a defect under this warranty.
 - Warranties do not cover any loss or damage resulting from improper installation, unauthorized repairs or modifications, improper use of electrical/power supply, loss of power, dropped product, a malfunction or damage of an operating part from failure to provide manufacturer's recommended maintenance, transportation damage, theft, abuse, misuse, neglect, vandalism or environmental conditions (fire, floods, rust, corrosion, sand, dirt, windstorm, hail, earthquake or exposure to weather conditions).
 - Warranties do not cover any loss during the time spent waiting for parts or repairs.
 - Damage due to shipping and handling does not constitute a defect under this warranty.
 - Under no circumstance shall Cozzia or its representatives be liable for indirect, consequential, or incidental damages (including damages for lost profits, business interruption, bodily injury, medical and the like).
 - Warranties are non-transferable.
 - Cozzia's sole liability and the purchaser's exclusive remedy shall be for the repair, or at Cozzia's option, for the replacement of the defective part.
 - Notwithstanding the above, if replacement parts for defective materials are not available, Cozzia reserves the right to make substitutions in lieu of repair or replacement.
-
- All warranties begin on the DATE OF PURCHASE; no allowance or extension is offered for delivery and/or installation.
 - Warranties do not apply to rental, business, commercial, institutional or other non-residential users.



861 S. Oak Park Road,
Covina, CA 91724

TEL: 1-877-977-0656
FAX: 1-800-521-4712
SERVICE@COZZIAUSA.COM

WWW.COZZIAUSA.COM