



Scan to see the online manual.



OWNER'S MANUAL

STYLER

Read this owner's manual thoroughly before operating the appliance and keep it handy for reference at all times.

ENGLISH

S5WBC



MFL71825950
Rev.00_013123

www.lg.com

Copyright © 2023 LG Electronics Inc. All Rights Reserved.

TABLE OF CONTENTS

3 IMPORTANT SAFETY INSTRUCTIONS

- 3 READ ALL INSTRUCTIONS BEFORE USE
- 3 WARNING STATEMENTS

7 PRODUCT OVERVIEW

- 7 Product Features

10 INSTALLATION

- 10 Before Installing
- 11 Installation Location Requirements
- 13 Unpacking the Appliance
- 13 Leveling the Appliance

16 OPERATION

- 16 Operation Overview
- 16 Preparing Loads
- 17 Checking Items before Every Load
- 19 Loading the Appliance
- 24 Control Panel
- 26 Cycle Table
- 31 Options and Extra Functions

32 SMART FUNCTIONS

- 32 LG ThinQ Application
- 34 Smart Diagnosis™ Function

36 MAINTENANCE

- 36 Regular Cleaning

38 TROUBLESHOOTING

- 38 FAQs
- 38 Before Calling for Service

42 LIMITED WARRANTY

- 42 USA

IMPORTANT SAFETY INSTRUCTIONS

READ ALL INSTRUCTIONS BEFORE USE

Safety Messages

Your safety and the safety of others are very important.

We have provided many important safety messages in this manual and on your appliance. Always read and follow all safety messages.



This is the safety alert symbol.

This symbol alerts you to potential hazards that can kill or injure you and others. All safety messages will follow the safety alert symbol and either the word **WARNING** or **CAUTION**.



WARNING

You may be killed or seriously injured if you do not follow instructions.



CAUTION

You may be injured or cause damage to the product if you do not follow instructions.

All safety messages will tell you what the potential hazard is, tell you how to reduce the chance of injury, and tell you what may happen if the instructions are not followed.

WARNING STATEMENTS



WARNING

- To reduce the risk of explosion, fire, death, electric shock, scalding or injury to persons when using this appliance, follow basic precautions, including the following:

Installation

- Contact an authorized service center before installing or relocating the appliance to avoid injury or product damage when moving the appliance.
- When moving the appliance away from the wall, be careful not to roll over or damage the power cord.
- The appliance is heavy. Two or more people are necessary to move and install the appliance to prevent damage or injury.
- Prior to use, ensure that you are connecting the appliance to a dedicated grounded electrical outlet rated for use with this appliance. It is the user's responsibility to replace a standard 2-prong wall outlet with a standard 3-prong wall outlet.
- Before use, the appliance must be properly installed as described in this manual. Electric shock can result if the appliance is not properly grounded.
- Do not install the appliance where there may be a danger of the unit falling. The appliance is not designed for use on ships or airplanes. Check with an authorized LG service center for use under other special circumstances.
- Do not tamper with controls.
- Install the appliance where the floor is firm and level. The appliance may vibrate excessively and eventually fall if installed on an unstable surface, causing damage or injury.
- Keep the front side protected when transporting the appliance. Do not truck from the front. The tempered glass panel on the front of the appliance may break, causing damage or injury.
- Properly ground the appliance to conform to all governing codes and ordinances. Follow the details in the installation instructions. Electric shock can result if the appliance is not properly grounded.

4 IMPORTANT SAFETY INSTRUCTIONS

- Install and store the appliance where it will not be exposed to temperatures below freezing or exposed to the weather. Allow the appliance to warm to room temperature before use if it was delivered in winter or at sub-zero temperatures.
- Do not repair or replace any part of the appliance or attempt any servicing unless specifically recommended in the user-maintenance instructions or in published user-repair instructions that you understand and have the skills to carry out. Failure to follow this warning can cause serious injury, fire, electric shock, or death.
- To reduce the risk of electric shock, do not install the appliance in humid spaces such as a bathroom. Failure to follow this warning can cause death, serious injury, fire, electric shock, or product deformation or malfunction.
- Remove all packing items and dispose of all shipping materials properly. Failure to do so can result in burns, fire, explosion, or death.
- Connect to a properly rated, protected, and sized power circuit to avoid electrical overload. Improper power circuits can melt, creating electric shock and/or fire hazard.
- Keep all packaging from children. Packaging material can be dangerous for children. There is a risk of suffocation.
- Do not install near another heat source such as a stove, oven or heater. Failure to follow this warning can cause product deformation, smoke, or fire.
- Do not place candles, smoking materials, or other flammables on top of the appliance. Dripping wax, smoke, or fire can result.
- Remove all protective vinyl film from the appliance. Failure to do so can cause product damage, smoke, or fire.
- Certain internal parts are intentionally not grounded and may present a risk of electric shock only during servicing, Service personnel - Do not contact the following parts while the appliance is energized: pump, valve, motor, control board.

Operation

- Do not allow children to play on or in the appliance. Close supervision of children is necessary when the appliance is used near children.
- Do not climb, stand, or hang on the door or on the shelf or anywhere inside the appliance. The appliance could fall over or be damaged, or other damage or injury could occur.
- Do not step on the doors to the water tanks. The appliance could fall and cause damage and injury.
- Do not place heavy or dangerous objects on top of the appliance.
- Do not put live animals inside the appliance.
- Do not allow children to climb into the appliance.
- In the event of a gas leak (propane/LPG), ensure adequate ventilation and contact an authorized service center before resuming use. Do not touch or disassemble the electrical outlet of the appliance.
- Do not use or place flammable substances (chemicals, medicine, cosmetics, etc) near the appliance or store them inside the appliance. Do not place the appliance in the vicinity of flammable gas.
- Disconnect the power cord immediately if you hear a noise, smell a strange odor or detect smoke coming from the appliance.
- In the event of a flood: Do not go near the appliance when its base is submerged under water. Contact the service center. There is a risk of electric shock or fire.
- Do not use fabric softeners or products to eliminate static unless recommended by the manufacturer of the fabric softener or product.
- Do not place hands or body near the steam nozzle during operation. The steam is hot and could cause an injury.
- Do not insert objects into the steam nozzle. Excessive noise and fire could result.
- Do not drink the water from the water supply or drain tanks.

- Do not disassemble or modify the appliance.
- Do not put hands, feet, or metal objects below the appliance.
- Do not operate the appliance or touch the power cord with wet hands.
- Keep fingers out of pinch point areas; clearances between the door and cabinet are necessarily small. Be careful closing the door when children are nearby.
- This appliance is not intended for use by persons (including children) with reduced physical, sensory or mental capabilities, or lack of experience and knowledge, unless they have been given supervision or instruction concerning the use of the appliance by a person responsible for their safety.
- Do not place items exposed to cooking oils in the appliance. Items contaminated with cooking oils may contribute to a chemical reaction that could cause a load to catch fire.
- Do not dry articles that have been previously cleaned in, washed in, soaked in, or spotted with gasoline, dry-cleaning solvents, or other flammable or explosive substances, as they give off vapors that could ignite or explode.
- Do not use heat to dry articles containing foam rubber or similarly textured rubber-like materials.
- Do not open door during operation. The performance of the product may be adversely affected. If the product is installed on or near carpet, condensation from escaping hot air or steam may stain or damage the carpet.
- Do not use the product for other than the intended purposes. Damage incurred by using the product for purposes other than those specified in this user manual are not covered by the warranty.

Connecting Electricity

- Do not, under any circumstances, cut or remove the ground prong from the power cord. To prevent personal injury or damage to the appliance, the electrical power cord must be plugged into a properly grounded outlet.
- This appliance must be plugged into a 120-VAC, 60-Hz grounded outlet protected by a 15-ampere fuse or circuit breaker. Failure to follow these instructions can result in fire, explosion, or death.
- This appliance must be plugged into a properly grounded outlet. Electrical shock can result if the appliance is not properly grounded. Have the wall outlet and circuit checked by a qualified electrician to make sure the outlet is properly grounded. Failure to follow these instructions can create an electric shock hazard and/or a fire hazard.
- Install the appliance where the plug is easily accessible. Unplug the appliance when not in use to avoid risk of fire or electric shock.
- Unplug the appliance before disassembly or repair to avoid risk of electric shock.
- The appliance should always be plugged into its own individual electrical outlet which has a voltage rating that matches the rating plate. This provides the best performance and also prevents overloading house wiring circuits which could cause a fire hazard from overheated wires.
- Do not use an extension cord to connect to an outlet. Doing so could result in a fire or electric shock.
- Never unplug your appliance by pulling on the power cord. Always grip the plug firmly and pull straight out from the outlet. The power cord can be damaged, resulting in a risk of fire and electric shock.
- Contact LG or a qualified repair person immediately to repair or replace all power cords that have become frayed or otherwise damaged. Do not use a cord that shows cracks or abrasion damage along its length or at either end. The power cord can melt, creating electric shock and/or fire hazard.
- When installing or moving the appliance, be careful not to pinch, crush, or damage the power cord. This will prevent injury and damage to the appliance from fire and electric shock.
- Do not use a portable multi-socket outlet which is not properly grounded. If needed, use only a multi-socket outlet which is properly grounded and has a rating of 15 A or higher. Failure to do so may result in electric shock or fire caused by the device overheating. If the circuit breaker on the device trips, it could turn off power to the appliance.

Maintenance and Disposal

- Wipe foreign objects (such as dust and water) off the prongs of the power plug and contact areas regularly. Do not use a wet or damp cloth when cleaning the plug.
- Do not use an appliance to dry the interior. Do not light a candle to remove interior odors.
- Do not spray water onto the appliance directly when cleaning. A fire or electric shock may occur.
- Wipe the interior with a dry cloth after use.
- Clean the lint filter before or after each load.

Grounding Instructions

- This appliance must be grounded. In the event of malfunction or breakdown, grounding will reduce the risk of electric shock by providing a path of least resistance for electric current.
- This appliance must be equipped with a cord having an equipment-grounding conductor and a grounding plug. The plug must be plugged into an appropriate outlet that is properly installed and grounded in accordance with all local codes and ordinances.
- Do not modify the plug. If it will not fit the outlet, have a proper outlet installed by a qualified electrician.
- Do not use a bleaching agent such as oxygen- or chlorine-based bleaches on the exterior of the appliance. They may cause discoloration when applied to the surface of the product.
- Do not use sharp objects when cleaning or operating the controls. An electric shock may occur.
- Avoid hitting the front glass panel with heavy objects. Although it is made of tempered glass, the panel may break in the event of a strong impact and cause injury.
- Keep the appliance free from rodents, insects, and other foreign objects. They may damage wires, causing fire or electric shock.
- Before the appliance is removed from service or discarded, remove the door to the drying compartment. Cut off the power plug and destroy the button section to prevent reuse.
- This appliance must be connected to a grounded metal, permanent wiring system or an equipment-grounding conductor must be run with the circuit conductors and connected to the equipment-grounding terminal or lead on the appliance. Electric shock can result if the appliance is not properly grounded.
- Improper connection of the equipment grounding conductor can result in a risk of electric shock. Check with a qualified electrician or service person if you are in doubt that the appliance is properly grounded.

SAVE THESE INSTRUCTIONS

PRODUCT OVERVIEW

Product Features

The images in this guide may be different from the actual components and accessories, which are subject to change by the manufacturer without prior notice for product improvement purpose.

Interior

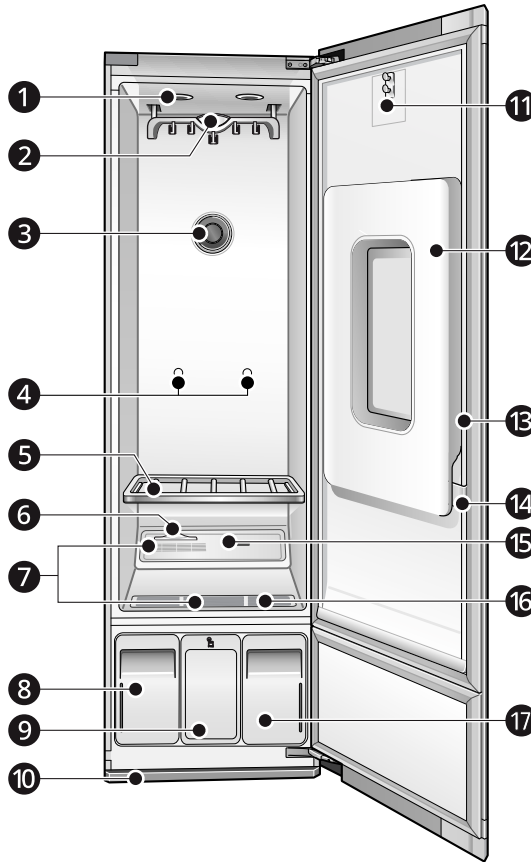

- ❶ Interior light
- ❷ Moving hanger
- ❸ Interior light
- ❹ Shelf holder
- ❺ Shelf
- ❻ Aroma filter
- ❼ Hot air circulation vent
- ❽ Water drain tank
- ❾ Accessory case
- ❿ Drip tray
- ⓫ Hooks for Pants Crease Care

- ⓬ Pants Crease Care
- ⓭ Door†
- ⓮ Clip
- ⓯ Steam nozzle
- ⓰ Lint filter
- ⓱ Water supply tank

† The door swing can be reversed by the installer to fit the installation location.

Specifications

Asterisks indicate model variants and can vary (0-9) or (A-Z).

Model	S5WBC
Electrical Requirements	120 V~, 60 Hz
Net Weight	220 lb (100 kg)
Rated Power	1500 W
Maximum Capacity	6 items

Dimensions

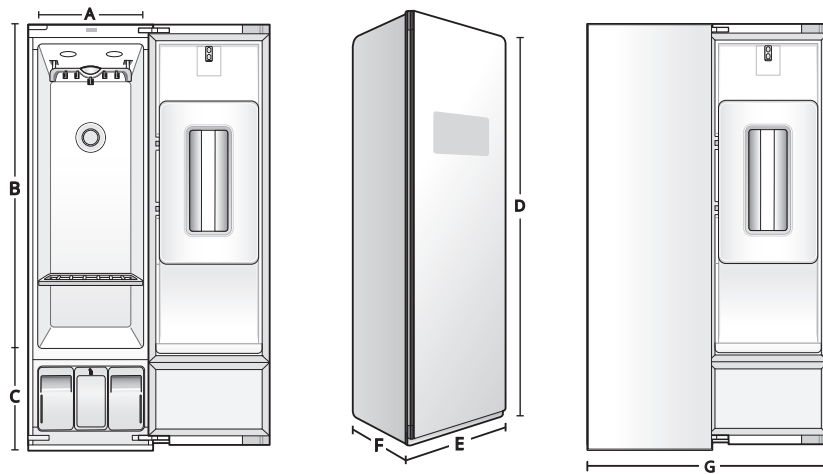

	Dimensions (inch / mm)	
	inch	mm
A	20 1/2	520
B	59	1500
C	18	460
D	77 1/4	1960
E	23 5/8	600
F	23 3/4	605
G	46 7/8	1190

Accessories

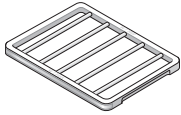

Shelf



Drip tray



5 Regular Hangers

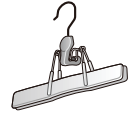

Pants Hanger

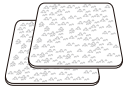

2 Non-skid Pads



Wrench

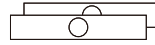

2 Hinge Covers



2 Rear Leveling Feet

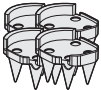

4 Carpet Install Spikes



Aroma Sheets

NOTE

- The included accessories vary depending on the model you purchased.
- Contact the store where the appliance was purchased or LG customer service if any accessories are damaged or missing.
- For your safety and for extended product life, use only authorized components. The manufacturer is not responsible for product malfunction or accidents caused by the use of separately purchased unauthorized components or parts.

INSTALLATION

Before Installing

Installation Overview

Please read the following installation instructions first after purchasing this appliance or transporting it to another location.

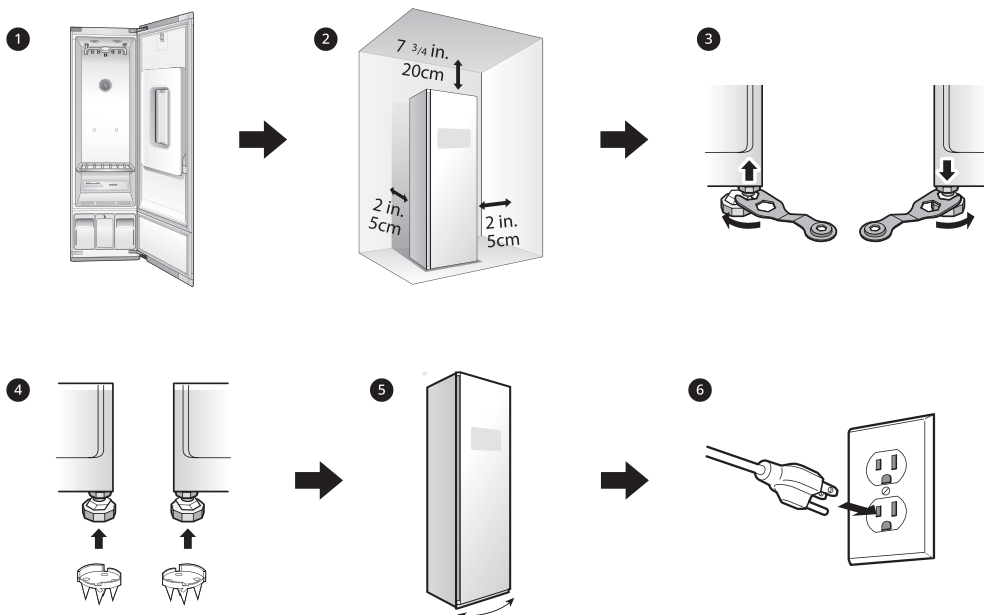

- ❶ Unpack and remove shipping material
- ❷ Check and choose the proper location
- ❸ Level the appliance
- ❹ Install carpet spikes[†]
- ❺ Reverse the door swing[†]
- ❻ Connect to grounded outlet

[†] If needed.

Installation Location Requirements

Before installing the appliance, check the following requirements for the installation location.

Installation Location

- A grounded electrical outlet should be located within 2 ft. (61 cm) of either side of the appliance.
- Install the appliance on a level floor. (Allowable slope under the appliance: 1°)
- The floor must be level, with a maximum slope of 1 inch (2.5 cm) under the appliance. If the slope is greater than 1 inch (2.5 cm), the appliance cannot be levelled properly.
- The appliance should be easily accessible if it needs to be serviced.
- Do not install the appliance in an area where it will be exposed to water and/or weather. Failure to follow this warning could result in risk of electric shock, injury, or product damage or malfunction.
- Do not install the appliance on a hollow or flexible platform. Doing so may cause excessive noise and vibration and result in damage or injury if the appliance tips over.

NOTE

- A sturdy floor should support the total appliance weight of **220 lb (100 kg)**. The combined weight of any other laundry appliances should also be considered.

Recommended Installation Spacing

The following clearances are recommended for the appliance. Although the appliance has been tested for clearances of 1 3/16 in. (3 cm) on the

sides and rear, recommended clearances should be considered for the following reasons:

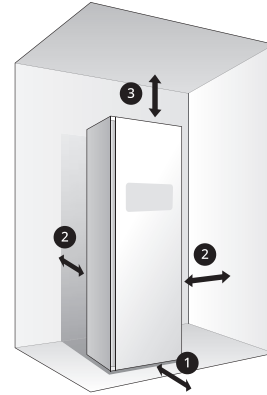

- ➊ Allow at least **24 in. (61 cm)** in front to open the door.
- ➋ Allow at least **2 in. (5 cm)** on both sides and between the back of the appliance and the wall.
- ➌ Allow at least **7 3/4 in. (20 cm)** between the top of the appliance and any overhanging shelves or cabinets.

NOTE

- If the appliance is too close to adjacent items, performance may decrease and electricity consumption may increase.
- Additional space should be considered on all sides of the appliance to reduce noise transfer.

Installation Spacing for Recessed Area or Closet Installation

There should be at least a little space around the appliance (or any other appliance) to avoid contact with walls, furniture, or other appliances during operation. Allow a minimum of 1 3/16 in. (3 cm) on all sides of the appliance to avoid increased noise or damage.

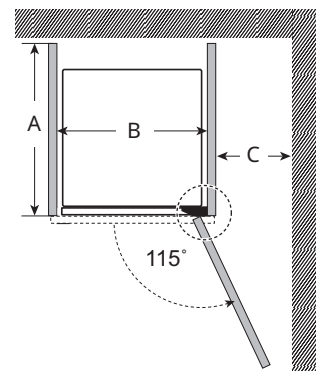

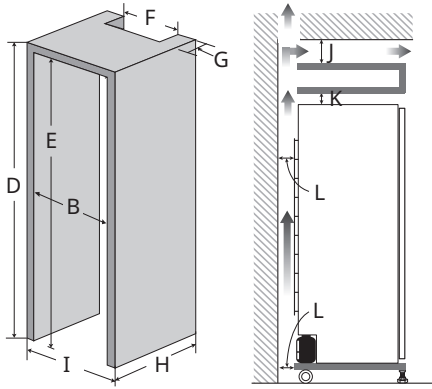

	Dimensions	
	inch	mm
A	≥ 26 3/8	≥ 670
B	≥ 24 1/4	≥ 610
C	≥ 10	≥ 250
D	≥ 78 3/4	≥ 1999
E	≥ 78 1/4	≥ 1985
F	≥ 21 13/16	≥ 555
G	≥ 2	≥ 50
H	≥ 25 5/8	≥ 650
I	≥ 25 1/4	≥ 640
J	≥ 2	≥ 50
K	≥ 1	≥ 25
L	≥ 2	≥ 50

NOTE

- For closet installation, with a door, minimum ventilation openings in the top and bottom of the door are required. Louvered doors with equivalent ventilation openings are acceptable.
- Minimum vent opening for built-in installation is 31.5 sq. in. (200 cm².)

Closet Ventilation Requirements

Closets with doors must have both an upper and lower vent to prevent heat and moisture build-up in the closet.

One example shown uses vent grilles in the door.

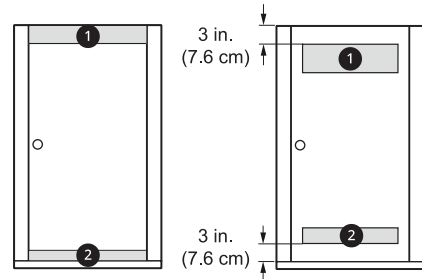

- 1 Upper vent opening with a minimum opening of **48 sq. in. (310 cm²)** must be installed no lower than **6 ft. (185 cm)** above the floor.
- 2 Lower vent opening with a minimum opening of **24 sq. in. (155 cm²)** must be installed no more than one foot above the floor.

Ambient Temperature

- Temperature must be between **50 °F (10 °C)** and **95 °F (35 °C)**.
- If the ambient temperature is too low or high, performance may be affected.
- Do not install in direct sunlight or where the temperature may fall below **32 °F (0 °C)**.

Electrical Connection

- Do not use an extension cord or 2-outlet adapter.
- Do not overload the outlet with more than one appliance.
- Connect the appliance to an earthed socket in accordance with current wiring regulations.
- The appliance must be positioned close to outlets and the plug should be easily accessible.

⚠ WARNING

- The power cord must be plugged into an appropriate outlet that is installed and grounded/earthed in accordance with all local codes and ordinances.

Unpacking the Appliance

⚠ WARNING

- Use two or more people to unpack and move the appliance. Failure to do so can result in serious injury if the appliance tips or falls.

Removing Carton and Shipping Materials

Unpack the appliance from carton and remove any tape and temporary labels from the appliance.

- Do not remove any warning labels, the model and serial number label, or the technical sheet label that is located under the front of the appliance.

⚠ CAUTION

- Do not use sharp instruments, rubbing alcohol, flammable fluids, or abrasive cleaners to remove tape or glue. These products can damage the surface of the appliance.

NOTE

- Tape or glue residue can also be easily removed by rubbing a small amount of liquid dish soap over the adhesive with your fingers. Wipe with warm water and dry.

Moving the Appliance

Use the wheels ① at the bottom of the appliance to move the appliance. Push the appliance slowly from about halfway down the front side.

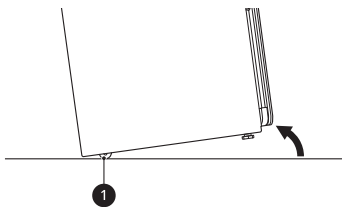

⚠ CAUTION

- Keep the appliance upright when moving it. If you lay the appliance on its side, refrigerant may leak and cause the appliance to malfunction.

Leveling the Appliance

Checking the Level

Leveling the appliance prevents unnecessary noise, vibration and movement. Check whether the appliance is perfectly level after installation.

⚠ WARNING

- The appliance is heavy. Two or more people are required when leveling the appliance. Failure to follow this warning can cause serious injury or death.

- 1 Position the appliance in the final location and check to make sure it is level.
 - All leveling feet must rest solidly on the floor. Gently push on the corners of the appliance to make sure that it does not rock from corner to corner. Make sure there are no gaps between the front leveling feet and the floor.
- 2 Use the wrench (packaged with the appliance) to turn the leveling feet.
 - Extend the front feet to raise the appliance or retract the feet to lower it. If unable to level the appliance using only the front feet, tip the appliance forward and install the two rear leveling feet. Do not lay the appliance down to install the leveling feet.
 - Raise or lower the appliance using the leveling feet until the appliance is level from side to side and front to back.

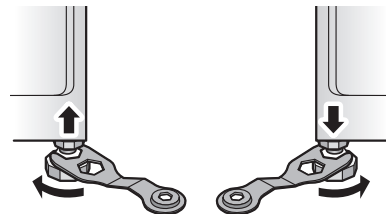

⚠ CAUTION

- Make sure that all leveling feet are in firm contact with the floor. If the appliance is used without leveling, it may fall, causing injury, damage, or product malfunction.
- Adjust the leveling feet only as far as necessary to level the appliance. Extending the leveling feet more than necessary can cause the appliance to vibrate.

14 INSTALLATION

- 3** When the appliance is completely stable and all leveling feet are resting solidly on the floor, tighten the locking nuts **1**.

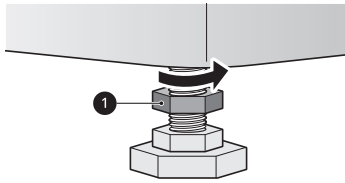

Installing on Carpeting

Follow these instructions when installing the appliance on carpeting.

! WARNING

- The appliance is heavy. Two or more people are necessary to install the rear leveling feet and carpet spikes. Failure to do so can result in back injury or other injury.
- Keep the appliance upright when moving and installing it. If you lay the appliance on its side, refrigerant may leak and cause the appliance to malfunction.

- 1** Move the appliance into its final location using the wheels at the bottom of the appliance.
- 2** Install the two rear leveling feet at the rear bottom of the appliance.
- Tip the appliance, do not lay it down, to install the leveling feet.

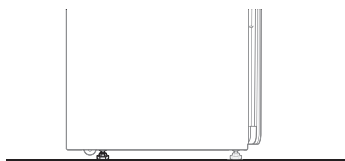

- 3** Level the unit following the instructions in **Leveling the Appliance**.
- 4** Install the four carpet spikes on the ends of the leveling feet, with the shorter, octagonal faces toward the front.

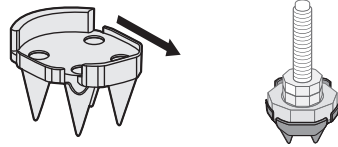

! WARNING

- Take care when handling the carpet spikes. They are designed to pierce through the carpet backing and pad and are very sharp.
- Keep fingers and hands out from under the spikes when setting the unit in place to avoid personal injury or product damage.

- 5** Level the appliance once more after installing the spikes.
- If the carpet has very deep pile or padding, the front feet may need to be extended slightly to install the drip tray.



If installing the appliance on carpeting:

- Be sure to check and empty the drip tray often.
- Do not open the unit during operation to avoid condensation forming on carpet surface, which may result in surface mold or mildew.
- Keep the bottom of the cabinet dry when filling or emptying water tanks. Keep the outside of the water tanks clean and dry to discourage growth of mold or mildew.

Reversing the Door

It is possible to reverse the direction of the door swing. This should be done by the installer at the time of installation, if desired.

NOTE

- If the direction of the door swing needs to be changed after installation, contact the LG Customer Information Center.

Using Non-skid Pads

Non-skid pads prevent the appliance from shaking or shifting when opening or closing the door.

- 1 Clean the floor to attach the non-skid pads.
 - Use a dry rag to remove foreign objects or moisture. If moisture remains, the non-skid pads may slip.
- 2 Adjust the level after placing the appliance in the installation area.
- 3 Place the adhesive side ❶ of the non-skid pads on the floor.

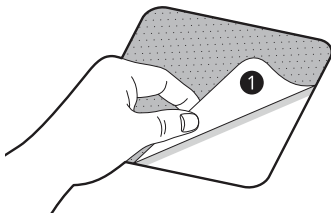

- 4 Move the appliance feet onto the non-skid pads.
 - Do not attach the adhesive side ❶ of the non-skid pads to the feet of the appliance.
- 5 Recheck the appliance's levelness.
 - Push or rock the edges of the appliance gently to make sure that the appliance does not rock. If the appliance rocks, level the appliance again.

NOTE

- The pads may leave a sticky residue when they are removed. The residue can be removed with alcohol.

Assembling the Drip Tray

Before using the appliance, insert the drip tray onto the bottom of the cabinet.

- 1 Hold the tray so the arrow and letter on the front of the tray face up.
- 2 Insert one side of the tray first, then the other. Push the tray until it slides completely in.

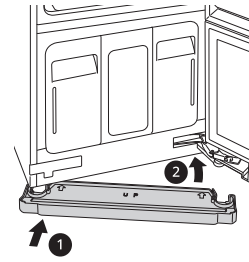

- 3 To detach, pull one side out then the other.
 - If the tray collects water, detach it and empty the water. After emptying it, reassemble the tray.

CAUTION

- Do not operate the appliance without installing the drip tray. Doing so could lead to water damage caused by leaking.

Installing Hinge Covers

- 1 Open the appliance door.
- 2 Snap a hinge cover onto the upper hinge assembly with the bent edge on the far side from the hinge.

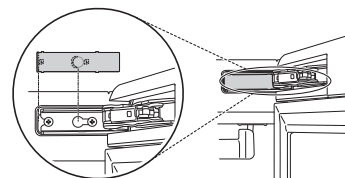

- 3 Repeat with the remaining hinge cover on the lower hinge assembly.

OPERATION

Operation Overview

Using the Appliance

1 Prepare items.

- Wash clothes first, if needed.
- Exclude heat-sensitive items or items that can be damaged by exposure to water.
- Place items on hangers or the shelf.
- Fasten buttons and close zippers to keep items on moving hangers and prevent damage.

2 Clean the lint filter and change the sheet in the aroma filter.

- Lift out filter and remove lint from last load for faster and more efficient performance. Reinstall filter, checking alignment when closing grille. Do not operate the appliance without the lint filter in place. If using a fabric softener sheet in the aroma filter, change it after every use.

3 Check the water tanks.

- Fill water supply tank if needed. Empty water drain tank if needed. Use clean tap water in the supply tank for better product performance and lifespan. Do not use distilled water or reuse water from the drain tank.

4 Load the appliance.

- Pay attention to fabric care labels and cycle choice. If clothing is not appropriate for the cycle selected, it may shrink or be seriously damaged.
- Remove all empty hangers to avoid noise, friction, and damage to clothing.

5 Turn on the appliance.

- Touch **Power** button to turn on the appliance.

6 Choose a desired cycle.

- Touch a cycle selector button. Press the button repeatedly to toggle through the selections.

7 Begin a cycle.

- Touch and hold the **Start/Pause** button to begin a cycle. Pause a cycle at any time by touching **Start/Pause** again. If you do not press the **Start/Pause** button to resume a cycle within a certain time, the appliance turns off automatically and all cycle settings are lost.
- Do not open the door during a cycle. If steam or hot air escapes, condensation may collect on the floor or walls, resulting in damage or mold.

CAUTION

- Do not open the door during operation. There is a risk of burns or injury from escaping hot air or steam.
- Do not allow steam or hot air to escape the cabinet during operation. Opening the door during operation affects performance, lengthens styling time, and results in water condensing and collecting on the floor.

8 End of cycle.





- Remove items when the cycle finishes. Leave the door open to let hot air escape. The interior light shuts off after 1.5 minutes if the door is left open.

Preparing Loads

Checking Fabric Care Labels

Most articles of clothing feature fabric care labels that include instructions for proper care. Below are some of the symbols that are relevant to choosing appropriate items for the appliance.

Symbols on Care Labels

Label	Meaning	Check
	Hand Wash	OK
	Machine Wash, Normal cycle	OK
	Perm press/wrinkle resistant	OK
	Gentle/delicate	OK

Label	Meaning	Check
	Do not wash	OK†
	Normal	OK
	Permanent press/wrinkle resistant	OK
	Gentle/delicate	OK
	Do not tumble dry	OK
	Do not dry	NO
	Line/hang dry	OK
	Drip dry	OK
	Dry flat	OK
	High	OK
	Medium	OK
	Low	OK
	No heat/air dry	NO

† Some fabrics marked with a "do not wash" label, such as fur and leather, can be used with the appliance.

Sorting Items

- For best fabric care results, always treat fabrics with similar care requirements together.
- Different fabrics have different care requirements, and some fabrics cannot be treated using certain cycles or should be treated separately.

Checking Items before Loading

Some items are not appropriate for use with the appliance. Using the wrong cycle for items can result in damage to fabrics.

- Check all pockets to make sure that they are empty. Items such as clips, pens, coins, and keys can damage both the appliance and your clothes.
- Do not put items that are sensitive to heat or are not suitable for washing with water in Styler cycles that use steam. Use the **Gentle Dry** cycle only.
- Fur and leather (only 100% real leather) should only be treated with the **Fur/Leather Care** cycle. This cycle is a downloadable cycle.

- Wash heavily soiled or stained clothes before putting them in the appliance. The appliance does not have a washing function. Loose soil or stains can be transferred between garments during cycles.
- Treat items with an unpleasant odor in a separate load. Odors can be transferred between items during cycles.
- Clothing should be securely fastened, with zippers and buttons closed, so that it does not fall off the moving hanger during the cycle.
- Do not put very wet items in the appliance to dry. Shake off or wring out excess water before putting items in the cabinet to dry. If a large amount of water pools in the cabinet, styling performance may suffer or the appliance may be damaged.

Checking Items before Every Load

Checking the Lint Filter

Always make sure the lint filter is clean before starting a new load; a clogged lint filter will increase styling times.

- 1 Open the front grille **1** and take out the lint filter **2**.

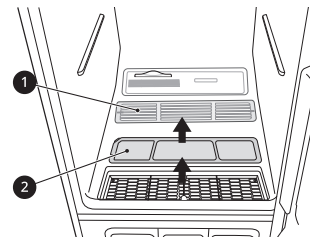

- 2 Brush the lint filter with a soft brush or clean it with a vacuum cleaner.
 - If the lint filter is torn or damaged, replace it with a new one.

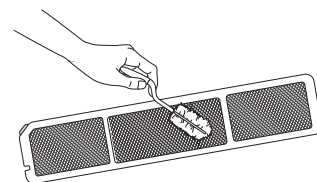

- 3 Reinstall the filter.

Checking the Aroma Filter

Use a dryer fabric softener sheet to add a refreshing aroma to items. Replace the fabric softener sheet after every use.

- 1 Remove the aroma filter from the appliance.

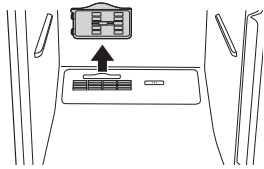

- 2 Open the aroma filter and insert a dryer fabric softener sheet ① into it.

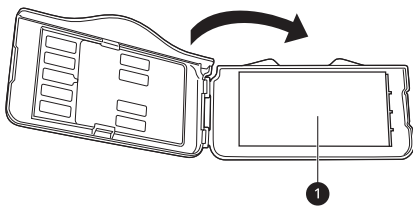

- 3 Close the aroma filter and insert it back in the appliance.

- Insert the aroma filter in the direction of the arrow. You can adjust the opening of the aroma filter using the adjustment lever. The more open the aroma filter is, the richer the aroma gets.

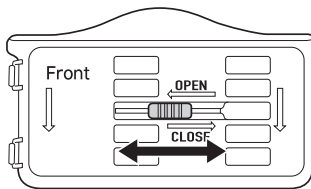

- 4 When the cycle is complete, remove the aroma filter and discard the fabric softener sheet.

- 5 Reinsert the aroma filter.

NOTE

- Instead of using a fabric softener sheet, you can spray perfume 4–5 times on a cotton pad and then place it in the aroma filter to use. (However, the fragrance strength can vary depending on the scent.)

Checking the Water Tanks

Check the water in the water tanks before use. The water supply tank must be filled with water before using the appliance. The appliance does not work without water. The water drain tank should be emptied before each use.

- 1 Pull the handle of the tank forward and remove the tanks from the appliance. Check the water level of the tanks.

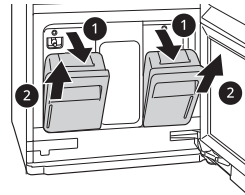

- 2 Make sure the water supply tank is filled with water.

- The full water supply tank can be used approximately four times, depending on the cycles used.
- Use clean tap water or bottled water for best performance and longer product life. Do not use distilled water or reuse the water from the drain tank.
- The first time the appliance is used, 2/3 of the water in the fully filled water supply tank is used. Less water is used in following cycles.

CAUTION

- Only use water when filling the water supply tank. Any other substance, such as detergent or fabric softener, may damage the appliance.
- Use only clean tap water or bottled water. Foreign materials in the water may shorten the lifespan of the appliance.
- Do not use distilled water. The water sensor may not work.
- Do not reuse the water in the drain tank to fill the water supply tank.

- 3 Make sure the water drain tank is empty.

- 4 The drain tank will be filled after about three uses. The tank fills more quickly during styling cycles. The appliance does not work if the drain tank is full.

- Some discoloration of the water drain tank may occur over time. This is normal and will not affect product performance.

Loading the Appliance

⚠ WARNING

- Flammable objects such as lighters or matches could ignite, causing a fire. Remove them from pockets to avoid fire, explosion, or death.
- Never style clothes that have been exposed to oil, gasoline, or other flammable substances. Failure to obey this warning can result in fire, explosion, or death.

Choosing a Styling Method

Item	How to style it
Suit coat, blazer	Moving hanger
Coat, jacket (short)	
Coat (long)	
Dress (short)	Moving hanger after removing shelf
Dress (long)	
Skirt	Moving hanger
Lightweight blanket, throw	
Baby blanket	
Pants (not creased)	
Shorts	
Children's clothes	
Scarf	
Tie	
Shawl	
Lingerie	Moving hanger or shelf (if delicate)
Shirt, blouse	
Pants (creased)	Pants Crease Care
Cap, hat	Shelf
Stuffed toys	
Pillow	
Sweater	
Knitwear	
Baby clothes	

The Moving Hanger

Hang clothes on the moving hanger using the hangers provided with the appliance, or use any plastic or metal hanger that hooks snugly into the indentations in the moving hanger.

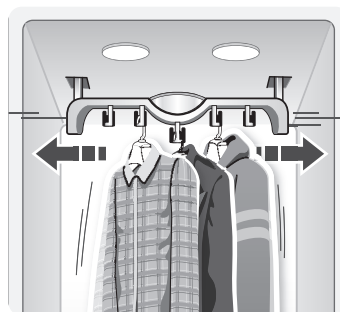

- Use the moving hanger for suits, coats, jackets, blouses, dresses, skirts, and pants that don't require a crease. Use the Pants Crease Care to crease pants.
- Anything that can be securely placed on a hanger and steamed or dried without retaining hanger marks or other damage can be placed on the moving hanger.
- Style sweaters or knits on the shelf to avoid hanger marks.
- Arrange clothing so it does not touch the sides or rear of the cabinet, if possible. Condensation may form on the interior surface of the cabinet, and items in contact with the surface may remain damp at the end of the cycle.
- The moving hanger will move even when only the shelf is being used.
- When using an ordinary metal/plastic hanger, the hook should be less than 5/32 in. (4 mm) thick and the hook must fit in the indentation in the moving hanger snugly. If the fit is too loose, it may result in vibration, noise and damage to clothing.

⚠ CAUTION

- Remove empty hangers from the moving hanger and place them on the shelf before starting a cycle. Empty hangers may cause unnecessary noise, friction, and damage to fabrics.
- Do not lean or pull on the moving hanger.
- Hang hangers in the same direction on the moving hanger to prevent collisions.
- Do not allow children to play with or hang onto the moving hanger. The appliance could tip, resulting in damage or injury.

Using the Moving Hanger

- 1 Insert hangers into slots and pull down to secure the hook snugly.
 - Hooks should fit in the slots snugly to prevent noise, vibration, or damage to items during operation.

NOTE

- Do not overcrowd items. The fewer items, the better the styling performance. Items that touch the sides of the cabinet may pick up condensation from the cabinet and fail to style completely.

Using Hangers

The hangers that come with the appliance are for use with the appliance only. Any plastic or metal hanger that has a hook less than 5/32" (4 mm) thick and hooks snugly into the indentations in the moving hanger can be used in the appliance.

- Do not use hangers with wool, knitwear, or delicate lingerie. The garments may stretch or be left with hanger marks.
- Wrinkles may appear at the back of the collar on some garments.
- Remove empty hangers or store them in the shelf during operation.
- Fasten buttons and zippers on hanging clothes to prevent them from falling off hangers during operation. Fasten the neck area with cotton string if there is no button or zipper.
- Remove or store the shelf when hanging longer items so items won't get wrinkled.

- 1 Select an appropriate hanger.
 - Choose the appliance hanger that fits the item you are hanging up.
- 2 Fasten the buttons and zippers on all garments and hang them on hangers.
 - Doing so helps keep the garments from falling or becoming more wrinkled during the cycle. If a garment has no buttons or

zipper, fasten it with a cotton string around the collar area.



- 3 Place the hangers into the slots of the moving hanger.



The Pants Hanger

Place pants either on the moving hanger or in the Pants Crease Care, depending on whether maintaining the creases on the pants legs is desired.

- Hanging pants on the moving hanger may reduce the creases on pants legs.
- To maintain the creases on pants legs, use the Pants Crease Care.
- Pants should be no wider than 44 1/16 in. (112 cm) or longer than 45 1/4 in. (115 cm) to fit in the Pants Crease Care. Check the size of the pants before using the Pants Crease Care. If pants are too large, use the moving hanger.
- The fabric content of the garments affects how well wrinkles are reduced.

Opening and Closing the Pants Hanger

- 1 To open, fold the hook down toward the hanger blades to unlock and separate the blades.

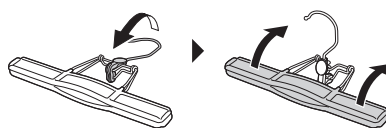

- 2 Once pants are inserted, bring the blades together and rotate the hook up and away from the blades to lock them in place.

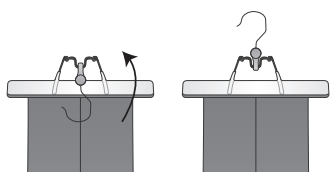

Hanging Pants On the Pants Hanger

- 1 Remove all objects from pants pockets and button the back pockets.
- 2 Fold pants along crease lines (or where crease lines would be), and attach the pants hanger at the ends of the pants legs.

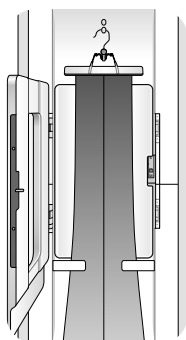

- 3 Tug gently on the sides of the pants legs. Make sure pants are stretched tight within the hanger, with no wrinkles, and will not fall out of the hanger during the cycle.

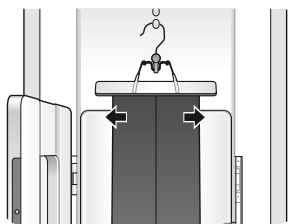

- 4 Place the pants hanger on the moving hanger or in the Pants Crease Care.



The Pants Crease Care

Hang clothes in the Pants Crease Care using the pants hanger provided with the appliance or any pants hanger that fits into the hooks above the door to the Pants Crease Care.

⚠ CAUTION

- Do not lean on or hang heavy items on the door of the Pants Crease Care. The appliance may tip, resulting in damage or injury.
- Do not allow children to play with or hang onto the door of the Pants Crease Care. The appliance may tip, resulting in damage or injury.
- Keep fingers out of pinch point areas when closing the door of the Pants Crease Care. Supervise nearby children to prevent injuries.

- 1 Open the Pants Crease Care by pressing on the icon on the side.

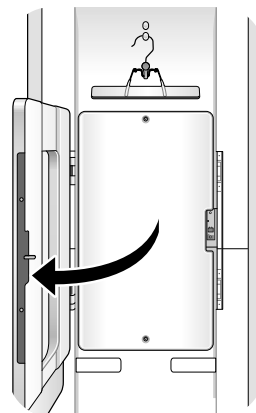

- 2 Hang the pants hanger on the hook above the Pants Crease Care that best fits the length of the pants being pressed.
 - If the pants are longer, use the higher hooks ① to keep the pants from hitting the floor of the cabinet.

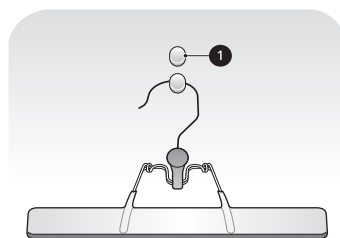

- Pants should be no wider than 44 1/16 in. (112 cm) or longer than 45 1/4 in. (115 cm). Check the size of the pants before using the

Pants Crease Care. If pants are too large, use the moving hanger.

- 3** Make sure the pants are hanging straight.
- Check the creases on the legs to make sure they are lined up. Fix the pants with 2 clips before closing the Pants Crease Care. If the pants legs are not aligned properly or the pants are not hanging straight, double lines may appear at the pants' edges, or the pants may be wrinkled.

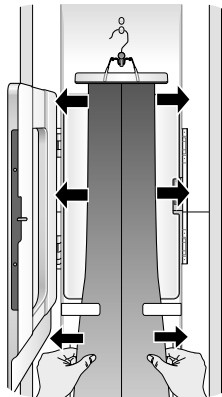

- 4** Close the Pants Crease Care, and then straighten the pants once more.
- Gently tug the edges of the pants to smooth out any wrinkles. Make sure the pants are hanging straight in the Pants Crease Care.

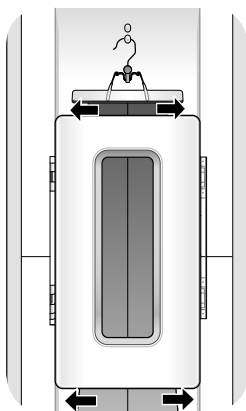

NOTE

- Pants can be pressed while refreshing other items in the same cycle.

- To avoid double creases, run the strong cycle with the moving hanger to remove any existing knife pleats, and then use the Pants Crease Care.
- For optimum results, use the Extra Pants Care cycle which is designed for use with the Pants Crease Care feature. This cycle can be downloaded using the **LG ThinQ** app and used as the Downloaded cycle.

The Shelf

Use the shelf when styling clothes or other items that are difficult to hang or that may be damaged by styling on a hanger.

CAUTION

- Do not allow children to climb on or hang on the shelf. The shelf may fall or the appliance may tip, resulting in damage or injury.
- Do not place heavy objects on the shelf or use it to store objects. The shelf may fall, resulting in damage or injury.

NOTE

- Use the shelf for sweaters, knits, lingerie, or delicate blouses that can show hanger marks, stretching, or other damage if dried on a hanger.
- For best styling performance, do not stack items on the shelf. Style single items or place items side by side with space between.
- When not in use, store the shelf on the shelf holder knobs in the back of the cabinet.
- Arrange items on the shelf so they do not touch the sides or rear of the cabinet, if possible. Condensation may form on the interior surface of the cabinet, and items in contact with the surface may remain damp at the end of the cycle.

Assembling the Shelf

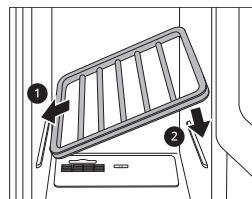

- 1** Hold the shelf so that the grey trim is toward the front.

- 2 Insert the left shelf groove into the left shelf support, then lower the right shelf groove onto the right shelf support.



NOTE

- The shelf cannot be assembled by sliding it into the cabinet. It will fall if not assembled properly.
-

- 3 To disassemble, lift up the right side of the shelf, then pull out the left side of the shelf from the shelf support.

NOTE

- Hang the shelf on the shelf holder when treating long clothes such as coats or dresses.

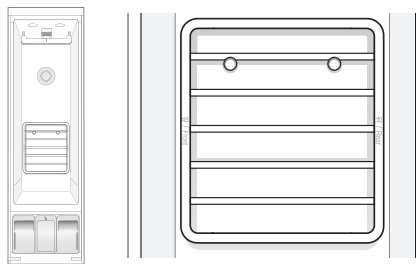

Storing Hangers

Remove unused hangers from the moving hanger and store them in the shelf during operation. This prevents noise and damage to clothing.

- 1 Insert the hangers between the rails of the shelf.

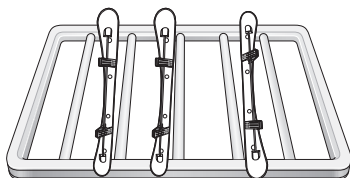

- 2 When styling long clothes, if the shelf is stored on the shelf holder, store the hangers outside the appliance during operation.

- 3 Do not use the shelf to store heavy items.

Control Panel

The control panel responds to touch using static electricity. A light touch is enough to operate it. Use a cloth when cleaning the controls to avoid contacting and activating the buttons. Foreign substances on the control, wearing gloves, or touching the buttons through cloth may prevent the buttons from activating.

Control Panel Features

Depending on the model, some of the following functions may not be available.

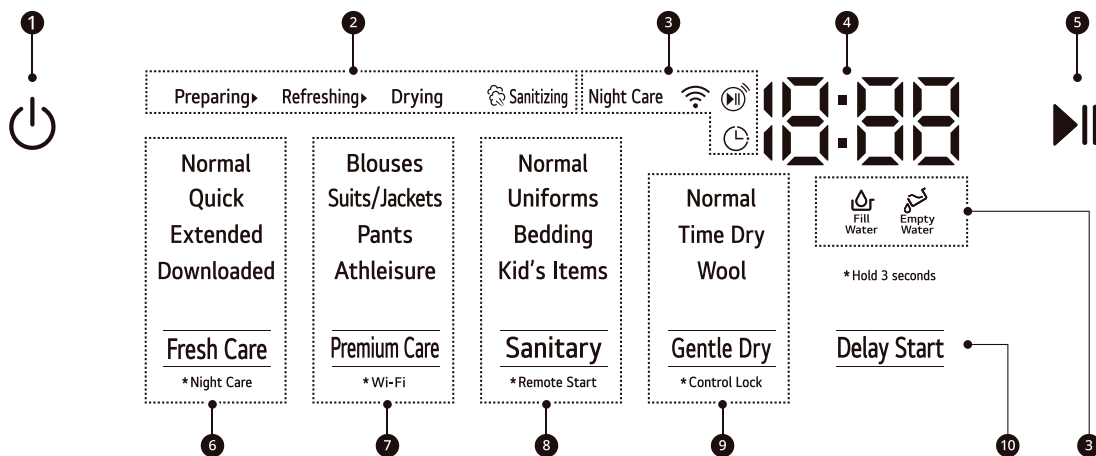

1 Power Button

Touch the **Power** button to turn the appliance On/Off. Once the cycle is complete, the appliance automatically turns off after a few seconds if no buttons are touched.

NOTE

- Touching the **Power** button during a cycle will cancel that cycle, and its settings will be lost.

2 Cycle Process Indicator

This portion of the display shows which stage of the styling cycle is currently underway.

3 Option and Alert Indicators

- **Night Care** lights up when the appliance is in **Night Care** mode.
- **Delay Start** lights up when the **Delay Start** feature is set.
- **Wi-Fi** lights up when the appliance is connected to a Wi-Fi network at home.
- **Remote Start** lights up when the appliance can be controlled remotely.
- **Fill Water** lights up when the water supply tank is missing or empty.
- **Empty Water** lights up when the water drain tank is missing or full.

4 Time Display

The display shows the estimated time remaining and error messages for the appliance. The cycle time may vary depending on usage conditions.

5 Start/Pause Button

Touch and hold to start the selected cycle. If the appliance is running, touch to pause the cycle without losing the current settings.

NOTE

- If the **Start/Pause** button is not pressed to start the selected cycle, after a delay the styler automatically turns off and all cycle settings are lost.
-

⑥ Fresh Care Cycle

Touch this button to select a **Fresh Care** cycle. Touch the button repeatedly to toggle through the selections.

- **Night Care**

- Touch and hold this button for 3 seconds to activate/deactivate the **Night Care** function.
-

NOTE

- Select the **Downloaded** setting to use specialized cycles available for download to your appliance. Use the provided default cycle or download a new cycle using the **LG ThinQ** application on a smartphone.
-

⑦ Premium Care Cycle

Touch this button to select a **Premium Care** cycle. Touch the button repeatedly to toggle through the selections.

- **Wi-Fi**

- Touch and hold this button for 3 seconds to connect the appliance to the **LG ThinQ** application.

⑧ Sanitary Cycle

Touch this button to select a **Sanitary** cycle. Touch the button repeatedly to toggle through the selections.

- **Remote Start**

- Touch and hold this button for 3 seconds to connect the appliance to a Wi-Fi network and control the appliance remotely.
- With the **LG ThinQ** app, you can use a smartphone to control your appliance remotely.
- In order to use the Remote Start function, refer to **SMART FUNCTIONS**.

⑨ Gentle Dry Cycle

Touch this button to select a **Gentle Dry** cycle. Touch the button repeatedly to toggle through the selections.

- **Control Lock**

- Touch and hold this button for 3 seconds to lock/unlock the control panel.

⑩ Delay Start

Touch this button to delay the start time of the cycle.

Cycle Table

The cycles are designed to fit a variety of situations. Select the cycle and setting that best match the load contents and desired results for maximum performance and fabric care.

Cycle Guide

Cycle	Fresh Care
Setting	Normal / Quick / Extended Refreshes clothes with high temperature steam and vibration. The cycle helps reduce odors in clothes.
	Downloaded: There are 5 specialized cycles which can be selected: Wool/Knit , Down Jacket Care , Fur/Leather Care , Dress Shirts , and Snow/Rain . <ul style="list-style-type: none"> • The first cycle (Wool/Knit by default) can be changed by downloading a different cycle. See the LG ThinQ app to check the downloaded cycle and its description. • Press the Fresh Care button repeatedly to toggle through the cycles.
Fabric / Clothes	Suits, coats, school uniforms, scarves, wool, knitwear, outdoor/performance clothing, towels, underwear, t-shirts, socks, jeans, jean jackets, lingerie, sportswear, tablecloths
Note	<ul style="list-style-type: none"> • Only use this cycle with washable clothing, because it uses steam. • Unlike the first downloaded cycle, the 4 preset cycles cannot be changed. The cycle codes appear in the time display to indicate the cycle selected. <ul style="list-style-type: none"> - Cycle code d_n1: Down Jacket Care - Cycle code d_n2: Fur/Leather Care - Cycle code d_n3: Dress Shirts - Cycle code d_n4: Snow/Rain

Cycle	Premium Care
Setting	<p>Blouses: Refreshes and removes light odors and reduces wrinkles in silk or silk-blend blouses, dresses, etc.</p> <p>NOTE</p> <ul style="list-style-type: none"> • Wrinkles may appear along seams, which are caused by the properties of silk and not any deformation or damage to the garment. • To minimize garment damage, the drying temperature for the Silk Cycle is relatively low. This may leave items feeling slightly damp.
	<p>Suits/Jackets: Refresh clothes with low-temperature steam and vibration. The setting helps you take care of suits and coats that contain natural fibers.</p>
	<p>Pants: Emphasizes the creases in trousers when used with the Pants Crease Care.</p> <p>NOTE</p> <ul style="list-style-type: none"> • Remove everything from the trouser pockets and close the back pocket buttons before use. • For best results, pull the trouser legs taut before sliding the sides into the clips. The trousers may wrinkle if they are folded or wrinkled when closing the Pants Crease Care. Smooth out the trousers after closing the Pants Crease Care.
	<p>Athleisure: Refreshes your leggings, sportswear and activewear so you can wear it again.</p>

Cycle	Sanitary
Setting	<p>Normal / Uniforms / Bedding / Kid's Items Use this cycle to steam clean and dry items. Choose this cycle for clothing, bedding, and children's clothing and soft toys. Quilts or blankets should be a single layer and weigh 3.3 lb (1.5 kg) or less.</p>
Fabric / Clothes	Suits, coats, school uniforms, scarves, outdoor/performance clothing, towels, underwear, t-shirts, socks, jeans, jean jackets, lingerie, sportswear, tablecloths
Note	<ul style="list-style-type: none"> • Do not use this cycle for wool or knitwear, because the high temperatures and steam can cause shrinkage. • Natural fibers must be marked washable/hand-washable and tumble dry, to avoid shrinkage. • Do not use with items containing rubber, foam, or adhesive.

Cycle	Gentle Dry
Setting	<p>Normal: Dries clothes using warm air and the moving hanger without tumbling. It is suitable for refreshing non-washable fabrics and natural fibers like 100% wool and cashmere.</p>
	<p>Time Dry: Use this setting to manually select the drying time, from 30 to 120 minutes, in 30-minute increments.</p>
	<p>Wool: Use this setting to dry delicate clothing such for wool/knit items.</p> <p>NOTE</p> <ul style="list-style-type: none"> • Make sure to use the shelf for wool/knit items.

Cycle	Gentle Dry
Note	• The amount of wrinkle reduction depends on the weight and fabric of the clothes.

NOTE

- Check **Fabric Care Guide** in this manual and fabric care labels on garment before styling.
- Wrinkles may remain in some items. Wrinkles caused by extended storage may be difficult to reduce. Wrinkles in cotton or linen may not be reduced completely. Iron after styling, if desired.
- Some odors can be difficult to remove. Odors from oily substances may be difficult for the steam to penetrate. Odors from extended storage may also be difficult to remove.
- Cycle times may vary depending on the usage environment, including the water temperature.
- Very thick clothing may not be dried uniformly at the end of the cycle.
- Cycle times may be longer for wet clothes that are not spin dried.

Process Details for Each Cycle

- **Preparing:** This process heats the water in the water tank in preparation for supplying steam.
- **Refreshing:** This process sprays steam on the clothes.
- **Drying:** This process removes moisture in the clothes.
- **Sanitizing:** This process uses high temperatures to treat clothes.

Cycle	Setting	Styling Process			
		Preparing	Refreshing	Drying	Sanitizing
Fresh Care	Normal	●	●	●	
	Quick	●	●	●	
	Extended	●	●	●	
Premium Care	Blouses	●	●	●	
	Suits/Jackets	●	●	●	
	Pants	●	●	●	
	Athleisure	●	●	●	
Sanitary	Normal	●	●	●	●
	Uniforms	●	●	●	●
	Bedding	●	●	●	●
	Kid's Items	●	●	●	●
Gentle Dry	Normal			●	
	Time Dry			●	
	Wool			●	

NOTE

- If the **Sanitary** cycle is changed to a **Fresh Care** or **Gentle Dry** cycle during operation, the **Sanitizing** process will be discontinued.

Fabric Care Guide

Fabric & Clothes	Cycle		
	Fresh Care	Sanitary	Gentle Dry
Cotton Towels, socks, underwear, jeans, sportswear, T-shirts, blankets	●	●	●
Linen, hemp, ramie Summer clothes, tablecloths	●	●	●
Alpaca, camel hair, cashmere Coats, suits	● [†]	● [†]	● [†]
Scarves, knitwear	● [†]		●
Fur, leather Coats, scarves	<ul style="list-style-type: none"> • Only use downloaded Fur/Leather Care cycle (low temperature drying). Only use with 100% genuine leather (not artificial leather). 		
Silk Neckties, ribbons, scarves, blouses, silk velvet/plush	<ul style="list-style-type: none"> • Only use downloaded Silk Care cycle (low temperature drying). 		
Wool Sweaters, knitwear	● [†]		●
Winter coats, suits, sportswear, uniforms	●	●	●
Acetate Suit lining, blouses, neckties, pajamas	●	●	●
Acrylic Thermal underwear, knitwear	●	●	●
Nylon Stockings, lingerie	●	●	●
Polyurethane (less than 5%) Stretchable clothing	●	●	●
Rayon Suit Lining	●	●	●

† Check fabric care labels in garments before use.

NOTE

- Fabrics come in a wide variety of weights and finishes and can have different care requirements for each variety. It is difficult to cover them adequately in this manual. Before using the appliance with any item, check the care label before proceeding.
 - Do not put items that are not colorfast, are heat-sensitive, or are not suitable for washing with water in the **Fresh Care** or **Sanitary** cycles. Do a water blot test on a small, inconspicuous spot (an inside seam) to determine if the fabric is colorfast. For further assistance, consult the clothing manufacturer, a dry cleaning professional, or a more detailed fabric care guide.
 - Using the appliance with items that are very wet or are not colorfast may result in damage to the items and staining from fabric dyes on the interior of the cabinet. These stains will not affect the operation of the appliance. Use toothpaste to remove stains from the interior of the cabinet.
 - The appliance does not have a washing function. Wash soiled items before use.
-

Options and Extra Functions

Night Care

Use this function to store items overnight or anytime items can't be removed soon after a cycle ends. The function periodically produces warm air to prevent condensation, keeping items warm and dry until they are removed.

- 1 Place clothes into the appliance.
- 2 Choose a cycle and setting.
- 3 Touch and hold **Sanitary** for 3 seconds to activate the **Night Care** function.
- 4 Touch **Start/Pause**.

NOTE

- Once set, the function starts after the selected cycle ends. To cancel the function, touch another cycle button.
- The function can't be set to follow a **Dehumidify** cycle.
- The settings are lost if you touch **Power**.
- The function runs for a maximum of 24 hours.
- It is safe to open the door at any time during the function, even when the air is blowing. If the door is opened during operation, the product will turn off automatically.
- When the option is set, [] appears on the time display until the feature is turned off.
- Some noise occurs periodically as warm air is produced.

Control Lock

Use this function to prevent unwanted use of the appliance or to keep cycle settings from being changed while the appliance is operating.

- 1 Touch and hold the **Gentle Dry** button for 3 seconds to activate or deactivate the control lock function.
- 2 [L] appears on the time display, and all controls are disabled except the **Power** button.

NOTE

- The function does not lock the door.
- The function is retained even if there is a power outage.
- Once set, the function remains active until it is manually deactivated. The function must be deactivated to run another cycle.

Delay Start

Use this function to delay the start time of the cycle.

- 1 Touch **Power** button.
- 2 Choose a cycle and setting.
- 3 Touch **Delay Start** button to set the start time of the cycle.
 - The default delay time is 3 hours. Each time you touch the button, the time increases by an hour, up to 19 hours.
 - Touch and hold the button to increase the delay time more quickly.

NOTE

- This option cannot be selected when the appliance is in the **Night Care** mode.

SMART FUNCTIONS

LG ThinQ Application

The **LG ThinQ** application allows you to communicate with the appliance using a smartphone.

LG ThinQ Application Features

Communicate with the appliance from a smartphone using the convenient smart features.

- **Energy Monitoring**[†]
 - This feature keeps track of how the appliance's power consumption is affected by selected cycles and options.
- **Remote Start**
 - Control the appliance remotely or check to see how much time is left in the cycle from the **LG ThinQ** application.

NOTE

- Once the **Remote Start** feature is enabled, you can start a cycle from the **LG ThinQ** application. If the cycle is not started, the appliance will wait to start the cycle until the appliance is turned off remotely or the **Remote Start** feature is disabled.
- If the door is opened, the **Remote Start** feature is disabled.

• Push Messages

- When the cycle is complete or the appliance has problems, you will receive a push message.

• Smart Diagnosis™

- This function provides useful information for diagnosing and solving issues with the appliance based on the pattern of use.

• Settings

- Allows you to set various options on the appliance and in the application.

† This feature is only available on some models.

NOTE

- If you change your wireless router, Internet service provider, or password, delete the connected appliance from the **LG ThinQ** application and connect it again.
- This information is current at the time of publication. The application is subject to change

for product improvement purposes without notice to users.

Before Using LG ThinQ Application

- 1 Check the distance between the appliance and the wireless router (Wi-Fi network).
 - If the appliance is too far from the router, the signal becomes weak. It may take a long time to register or installation may fail.
- 2 Turn off the **Mobile data** or **Cellular Data** on your smartphone.

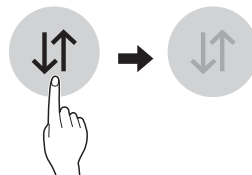

- 3 Connect your smartphone to the wireless router.

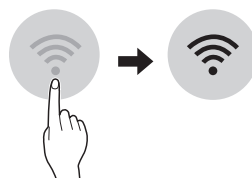

NOTE

- To verify the Wi-Fi connection, check that the  icon on the control panel is lit.
- The appliance supports 2.4 GHz Wi-Fi networks only. To check your network frequency, contact your Internet service provider or refer to your wireless router manual.
- **LG ThinQ** is not responsible for any network connection problems or any faults, malfunctions, or errors caused by network connection.
- The surrounding wireless environment can make the wireless network service run slowly.
- If the appliance is having trouble connecting to the Wi-Fi network, it may be too far from the router. Purchase a Wi-Fi repeater (range extender) to improve the Wi-Fi signal strength.
- The network connection may not work properly depending on the Internet service provider.

- The Wi-Fi may not connect or the connection may be interrupted because of the home network environment.
- If the appliance cannot be connected due to problems with the wireless signal transmission, unplug the appliance and wait about a minute before trying again.
- If the firewall on your wireless router is enabled, disable the firewall or add an exception to it.
- The wireless network name (SSID) should be a combination of English letters and numbers. (Do not use special characters.)
- Smartphone user interface (UI) may vary depending on the mobile operating system (OS) and the manufacturer.
- If the security protocol of the router is set to **WEP**, network setup may fail. Change the security protocol (**WPA2** is recommended), and connect the product again.

turned off remotely from the application or this function is disabled.

- If the door has been opened, you cannot start a cycle remotely.

Disabling Remote Start Manually

When the function is activated, press and hold the **Sanitary** button for 3 seconds.

Download Cycle

You can download new and specialized cycles that are not included in the standard cycles on the appliance.

Appliances that have been successfully connected to a Wi-Fi network can download a variety of specialty cycles specific to the appliance.

Once cycle download is completed in the appliance, the product keeps the downloaded cycle until a new cycle is downloaded.

To operate a downloaded cycle on the appliance, touch the **Fresh Care** button on the appliance repeatedly until the **Downloaded** setting is lit up.

There are a total of 5 downloaded cycles. Only the first cycle can be changed using the LG ThinQ smartphone application. The other 4 preset cycles cannot be changed. See the **Cycle Table** for details on the preset cycles.

Installing the LG ThinQ Application

Search for the **LG ThinQ** application from the Google Play Store or Apple App Store on a smartphone. Follow instructions to download and install the application.

Using the Appliance Remotely

Remote Start

Use a smartphone to control the appliance remotely. You can also monitor the cycle operation so you know how much time is left in the cycle.

Using Remote Start

- 1 Put the clothes into the appliance.
- 2 Touch the **Power** button.
- 3 Touch and hold the **Sanitary** button for 3 seconds to enable the **Remote Start** function.
- 4 Start a cycle from the **LG ThinQ** application on your smartphone.

NOTE

- Once the function is enabled, you can only start a cycle from the **LG ThinQ** smartphone application. If the cycle is not started, the application will wait to start the cycle until it is

Wireless LAN Module Specifications

Frequency Range	2412 - 2462 MHz
Output Power (Max)	< 30 dBm

FCC Notice

The following notice covers the transmitter module contained in this product.

This equipment has been tested and found to comply with the limits for a Class B digital device, pursuant to Part 15 of the FCC Rules. These limits are designed to provide reasonable protection against harmful interference in a residential installation. This equipment generates, uses, and can radiate radio frequency energy and, if not installed and used in accordance with the instructions, may cause harmful interference to radio communications. However, there is no guarantee that interference will not occur in a particular installation. If this equipment does cause harmful interference to radio or television

reception, which can be determined by turning the equipment off and on, the user is encouraged to try to correct the interference by one or more of the following measures:

- Reorient or relocate the receiving antenna.
- Increase the separation between the equipment and the receiver.
- Connect the equipment into an outlet on a circuit different from that to which the receiver is connected.
- Consult the dealer or an experienced radio/TV technician for help.

This device complies with part 15 of the FCC Rules. Operation is subject to the following two conditions:

(1) This device may not cause harmful interference and

(2) This device must accept any interference received, including interference that may cause undesired operation.

Any changes or modifications in construction of this device which are not expressly approved by the party responsible for compliance could void the user's authority to operate the equipment.

FCC RF Radiation Exposure Statement

This equipment complies with FCC radiation exposure limits set forth for an uncontrolled environment. This transmitter must not be co-located or operating in conjunction with any other antenna or transmitter.

This equipment should be installed and operated with a minimum distance of 20 cm (7.8 inches) between the antenna and your body. Users must follow the specific operating instructions for satisfying RF exposure compliance.

Industry Canada Statement

This device contains licence-exempt transmitter(s)/ receiver(s) that comply with Innovation, Science and Economic Development Canada's licence-exempt RSS(s). Operation is subject to the following two conditions:

(1) This device may not cause interference.

(2) This device must accept any interference, including interference that may cause undesired operation of the device.

IC Radiation Exposure Statement

This equipment complies with IC radiation exposure limits set forth for an uncontrolled environment.

This equipment should be installed and operated with a minimum distance of 20 cm (7.8 inches) between the antenna and your body.

NOTE

- THE MANUFACTURER IS NOT RESPONSIBLE FOR ANY RADIO OR TV INTERFERENCE CAUSED BY UNAUTHORIZED MODIFICATIONS TO THIS EQUIPMENT. SUCH MODIFICATIONS COULD VOID THE USER'S AUTHORITY TO OPERATE THE EQUIPMENT.
-

Open Source Software Notice Information

To obtain the source code that is contained in this product, under GPL, LGPL, MPL, and other open source licenses that have the obligation to disclose source code, and to access all referred license terms, copyright notices and other relevant documents, please visit <https://opensource.lge.com>.

LG Electronics will also provide open source code to you on CD-ROM for a charge covering the cost of performing such distribution (such as the cost of media, shipping, and handling) upon email request to opensource@lge.com.

This offer is valid to anyone in receipt of this information for a period of three years after our last shipment of this product.

Smart Diagnosis™ Function

Use this feature to help you diagnose and solve problems with your appliance.

NOTE

- For reasons not attributable to LGE's negligence, the service may not operate due to external factors such as, but not limited to, Wi-Fi unavailability, Wi-Fi disconnection, local app store policy, or app unavailability.
 - The feature may be subject to change without prior notice and may have a different form depending on where you are located.
-

Using LG ThinQ to Diagnose Issues

If you experience a problem with your Wi-Fi equipped appliance, it can transmit troubleshooting data to a smartphone using the **LG ThinQ** application.

- Launch the **LG ThinQ** application and select the **Smart Diagnosis** feature in the menu. Follow the instructions provided in the **LG ThinQ** application.

Using Audible Diagnosis to Diagnose Issues

Follow the instructions below to use the audible diagnosis method.

- Launch the **LG ThinQ** application and select the **Smart Diagnosis** feature in the menu. Follow the instructions for audible diagnosis provided in the **LG ThinQ** application.

- 1** Touch the **Power** button to turn on the appliance.
 - Do not touch any other buttons or icons on the display screen.
- 2** Hold the mouthpiece of your phone in front of the **Power** button.

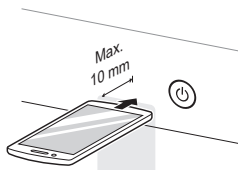

- 3** Touch and hold the **Gentle Dry** button for 3 seconds or longer while continuing to hold your phone near the **Power** button.
- 4** Keep the phone in place until the tone transmission has finished. The display will count down the time. Once the countdown is over and the tones have stopped, the diagnosis will be displayed in the application.

NOTE

- For best results, do not move the phone while the tones are being transmitted.

MAINTENANCE

⚠ WARNING

- Unplug the appliance before cleaning to avoid the risk of electric shock. Failure to follow this warning can cause serious injury, fire, electrical shock, or death.
- Never use harsh chemicals, abrasive cleaners, or solvents to clean the appliance. They will damage the finish.

Regular Cleaning

Cleaning the Interior and Exterior

Proper care of your appliance can extend its life.

- 1 Clean the inside and outside of the appliance with a damp cloth.
 - Glass cleaner can be used to clean the front glass panel, but spray it on a cloth and wipe rather than spraying it directly on the panel.
- 2 Buff the door dry with a clean, dry cloth to prevent any water stains.
- 3 Allow the interior and exterior to dry completely before plugging in and operating the appliance.

⚠ CAUTION

- Do not spray water directly on the appliance.
- Do not use detergent, methylated spirits, solvents, or any volatile liquids to clean the exterior of the appliance.
- Never use steel wool or abrasive cleansers; they can damage the surface.
- Keep sharp objects away from the exterior of the appliance. The touch panel may not work if damaged.

Cleaning the Lint Filter

Always remove the lint from the filter after every cycle. If the lint filter has become very dirty or clogged, wash the lint filter in warm, soapy water and allow to dry thoroughly before reinstalling.

- Never operate the appliance without the lint filter.
- Never operate the appliance with a wet lint filter.

Cleaning the Aroma Filter

For best results, wash the aroma filter using hot water and dish soap. After cleaning, wipe the filter with a clean cloth and allow it to dry thoroughly before reinstalling it.

The aroma filter can also be cleaned in the top rack of the dishwasher.

- Never operate the appliance without the aroma filter.
- Never operate the appliance with a wet aroma filter.

Cleaning the Water Tanks

The water in the water supply tank contacts the clothing and items treated in the appliance directly. Clean both tanks periodically and keep them clean at all times. If the tanks are not properly cleaned, they may start to smell or need to be replaced.

- Some discoloration of the water drain tank may occur over time. This is normal and will not affect product performance.
- Use only clean tap water in the supply tank for best performance and to prolong the life of the appliance. Do not use distilled water.
- Do not reuse the water from the water drain tank in the water supply tank.

- 1 Clean the exterior of the tanks with a wet cloth.
- 2 Clean the inside of the water tanks with a brush and clean water.



- 3** Make sure the drainage nozzle **1** connected to the water drain tank and the water supply hole **2** connected to the water supply tank are not clogged.

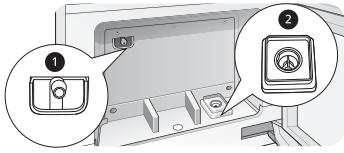

- 4** Allow the outsides of the tanks to dry completely before reinstalling the tanks.

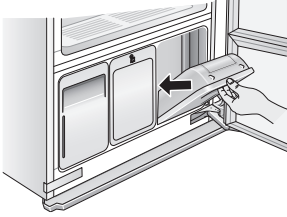

TROUBLESHOOTING

FAQs

Frequently Asked Questions

Q: What are aroma sheets and how do I use them?

A: You can use your favorite brand of dryer fabric softener sheets in the aroma filter to infuse items with a refreshing aroma. The sheets will not soften garments or reduce static. To use the aroma filter, add a softener sheet before running a cycle. Dispose of the softener sheet at the end of the cycle. For best performance, clean the aroma filter after every 5-7 uses. See **Checking the Aroma Filter**, and **Cleaning the Aroma Filter**.

Q: Can I put fur, leather, or silk items in the appliance?

A: Download the **Fur/Leather Care** cycle for use with fur or leather, or the **Silk Care** cycle for use with silk items in the appliance. For instructions on downloading new cycles for the appliance, see **Smart Functions** and the instructions in the **LG ThinQ** smartphone application.

Q: Why is the cycle time longer than estimated for the Gentle Dry cycle?

A: The appliance uses a sensor to sense the dryness of fabrics. If clothing or other items are not dried properly, the cycle time is extended automatically.

Q: Can I install the appliance on carpeting?

A: If installing on carpeting (especially on padded or deep pile carpets), stabilize the unit by installing the rear leveling legs and the four carpet spikes. For instructions, see **Installing on Carpeting**.

Extra care must be taken to keep the area around the machine clean and dry. Do not open the cabinet during operation. There is a risk of burns or injury, and condensation from escaping hot air or steam could result in damage to carpeting.

Before Calling for Service

Review this section before calling for service; doing so will save you both time and money.

Error Messages

Problem	Possible Cause & Solution
Fill Water icon is blinking.	Water supply tank is empty or tank is missing. <ul style="list-style-type: none"> Fill the water supply tank and reinstall it.
Empty Water icon is blinking.	Water drain tank is full or tank is missing. <ul style="list-style-type: none"> Empty the water drain tank and reinstall it.
dE error message shows on the display.	Door is not completely closed. <ul style="list-style-type: none"> Check that items are completely inside the cabinet and that the door is tightly closed.
RE, LE, LE2, E I, E4, EE I, EE2, EE3 or EE5 error message shows on the display.	System error. <ul style="list-style-type: none"> Unplug the appliance and call for service.
IF error message shows on the display.	Lint filter is missing. <ul style="list-style-type: none"> Install the lint filter in place.

Problem	Possible Cause & Solution
P5 error message shows on the display.	<p>Supply voltage is not correct.</p> <ul style="list-style-type: none"> • Please call LG service center. You can find your local LG service center phone number in the warranty card.

Operation

Problem	Possible Cause & Solution
The appliance won't operate.	<p>Control panel has powered off due to inactivity.</p> <ul style="list-style-type: none"> • This is normal. Touch the Power button to turn the appliance on.
	<p>Cord is unplugged.</p> <ul style="list-style-type: none"> • Make sure cord is plugged securely into a working outlet.
	<p>Circuit breaker/fuse is tripped/blown.</p> <ul style="list-style-type: none"> • Check house circuit breakers/fuses. Replace fuses or reset breaker. The appliance should be on a dedicated branch circuit.
	<p>Appliance is not connected to 120 V socket.</p> <ul style="list-style-type: none"> • Make sure the cord is plugged into a grounded socket rated for this appliance.
The cycle won't start.	<p>Start/Pause button was not touched after the cycle was set.</p> <ul style="list-style-type: none"> • Touch the Start/Pause button.
	<p>Cycle is producing steam.</p> <ul style="list-style-type: none"> • There may be a period of inactivity while steam is produced.
	<p>Control panel is locked.</p> <ul style="list-style-type: none"> • Disable the locking of the control panel and touch the Start/Pause button.
Steam or hot air comes out when the door is opened	<p>Door is opened during operation.</p> <ul style="list-style-type: none"> • It is normal for steam or hot air to escape if the door is opened during operation.
Full water supply tank is empty after just one use.	<p>Appliance is being used for the first time.</p> <ul style="list-style-type: none"> • A larger amount of water is needed the first time the appliance is used to fill the empty reservoir.
Appliance makes a loud vibrating noise on startup.	<p>Moving hanger is balancing load before operation.</p> <ul style="list-style-type: none"> • This is normal at the beginning of the cycle. If the noise increases or continues for a long time, call for service.
Styling times are taking longer than estimated.	<p>Clothes were extremely wet when loaded.</p> <ul style="list-style-type: none"> • Styling times may be longer for very wet or bulky clothing. Damp dry clothes before putting them in the appliance. The appliance stops automatically when clothes are dry.
Appliance is moving from left to right while operating.	<p>Floor under appliance is not level or is not sturdy enough to support the weight of the appliance without flexing.</p> <ul style="list-style-type: none"> • Install the appliance where the floor is level and sturdy. Compensate for any slight unevenness in the floor with the leveling legs.
Sound of motor whirring.	<p>Compressor is running during styling.</p> <ul style="list-style-type: none"> • This is normal.
Sound of water running, boiling, or hissing.	<p>Steam is being generated and sprayed onto clothes.</p> <ul style="list-style-type: none"> • This is normal.
Steam or hot air leaks out when the door is closed.	<p>An item is caught in the door, keeping it slightly open.</p> <ul style="list-style-type: none"> • Make sure all items are completely inside the cabinet and nothing is caught in the door, blocking it from closing completely.

Problem	Possible Cause & Solution
Control panel won't respond.	Control panel or button has dirt on it. <ul style="list-style-type: none"> Dirt or foreign objects on the control panel will interfere with the operation of the buttons. Clean the control panel.
	Control panel is locked. <ul style="list-style-type: none"> Disable the locking of the control panel. (See Control Lock for instructions.)

Performance

Problem	Possible Cause & Solution
Clothes are wet at the end of the cycle	Filter is clogged <ul style="list-style-type: none"> Clean the lint filter.
	Door gasket is damaged <ul style="list-style-type: none"> If the rubber door gasket is damaged, it leaves a gap in the door seal, affecting performance of the appliance. Call for service.
	Clothes caught in door <ul style="list-style-type: none"> Make sure all items are completely in the cabinet and not stuck in the door, blocking it from closing completely. Run the cycle again.
Odor is not removed at end of cycle.	Clothes were stored for a long period of time or are stained with a strong-smelling substance. <ul style="list-style-type: none"> Odors can be particularly difficult to remove from clothes that have been stored for long periods or have strong-smelling, oily stains. Wash the clothes first, before using the appliance.
Wrinkles are not reduced at end of cycle.	Clothes were stored for a long period of time. <ul style="list-style-type: none"> Wrinkles may be very difficult to reduce if set for a long time, especially in cotton and linen fabrics. Iron clothes that have been stored for a long period of time before treating them with the appliance, to reduce wrinkles more effectively.
Clothes have an unpleasant odor at end of cycle.	Appliance has not been used for a long time or water tanks and filters have not been cleaned. <ul style="list-style-type: none"> Check for dirt or foreign objects in the water supply and water drain tanks. Clean the filters and water tanks.
Functions are not operating properly.	Detergent or fabric softener put in water supply tank. <ul style="list-style-type: none"> Do not use anything but clean water in the water supply tank.
Wrinkles at back of neck after cycle.	Item too large for hanger or fabric too delicate. <ul style="list-style-type: none"> Use the right size hanger for the item so the fabric won't bunch up and cause wrinkles. Some fabrics are delicate and will bunch around the hanger no matter what you do. Use the shelf for lingerie and other delicate items.
Creases are gone from pants after cycle.	Pants were hung on the moving hanger, not in the Pants Crease Care. <ul style="list-style-type: none"> Hang pants in the Pants Crease Care to maintain creases at edge of pants legs.
Clothing has water spots after cycle, color has faded or run.	Fabric is not washable, or is not colorfast. <ul style="list-style-type: none"> Check fabric care labels before treating items.

Wi-Fi

Problem	Possible Cause & Solution
Trouble connecting appliance and smartphone to Wi-Fi network.	The password for the Wi-Fi network was entered incorrectly. <ul style="list-style-type: none"> • Delete your home Wi-Fi network and begin the connection process again.
	Mobile data for your smartphone is turned on. <ul style="list-style-type: none"> • Turn off the Mobile data on your smartphone before connecting the appliance.
	The wireless network name (SSID) is set incorrectly. <ul style="list-style-type: none"> • The wireless network name (SSID) should be a combination of English letters and numbers. (Do not use special characters.)
	The router frequency is not 2.4 GHz. <ul style="list-style-type: none"> • Only a 2.4 GHz router frequency is supported. Set the wireless router to 2.4 GHz and connect the appliance to the wireless router. To check the router frequency, check with your Internet service provider or the router manufacturer.
	The appliance and the router are too far apart. <ul style="list-style-type: none"> • If the appliance is too far from the router, the signal may be weak and the connection may not be configured correctly. Move the router closer to the appliance or purchase and install a Wi-Fi repeater.
	During Wi-Fi setup, the app is requesting a password to connect to the product (on certain phones). <ul style="list-style-type: none"> • Locate the network name which starts with "LG" under Settings > Networks. Note the last part of the network name. <ul style="list-style-type: none"> - If the network name looks like LGE_Appliance_XX-XX-XX, enter lge12345. - If the network name looks like LGE_Appliance_XXXX, enter XXXX twice as your password. For example, if the network name appears as LGE_Appliance_8b92, then you would enter 8b928b92 as your password. In this instance, the password is case sensitive and the last 4 characters are unique to your appliance.

LIMITED WARRANTY

USA

TERMS AND CONDITIONS

ARBITRATION NOTICE: THIS LIMITED WARRANTY CONTAINS AN ARBITRATION PROVISION THAT REQUIRES YOU AND LG ELECTRONICS (“LG”) TO RESOLVE DISPUTES BY BINDING ARBITRATION INSTEAD OF IN COURT, UNLESS YOU CHOOSE TO OPT OUT. IN ARBITRATION, CLASS ACTIONS AND JURY TRIALS ARE NOT PERMITTED. PLEASE SEE THE SECTION TITLED “PROCEDURE FOR RESOLVING DISPUTES” BELOW.

Should your LG Styler (“Product”) fail due to a defect in materials or workmanship under normal and proper use, during the warranty period set forth below, LG will, at its option, repair or replace the Product. This limited warranty is valid only to the original retail purchaser of the Product (“You”) and applies only when purchased lawfully and used within the United States including U.S. Territories.

WARRANTY PERIOD		
Period	Scope of Warranty	HOW SERVICE IS HANDLED
Two (2) years from date of original retail purchase	Parts and Labor (internal/functional parts only)	LG will provide parts and labor to repair or replace defective parts.
Ten (10) years from the date of original retail purchase	Inverter Compressor	Parts Only (You are responsible for any applicable labor cost)

- Replacement Products and parts are warranted for the remaining portion of the original warranty period or ninety (90) days, whichever is greater.
- Replacement Products and parts may be new, reconditioned, refurbished, or otherwise factory remanufactured.
- Replaced Product or part(s) will be the property of LG.
- Proof of original retail purchase specifying the Product model and date of purchase is required to obtain warranty service under this limited warranty.

EXCEPT TO THE EXTENT PROHIBITED BY APPLICABLE LAW, ANY IMPLIED WARRANTY OF MERCHANTABILITY OR FITNESS FOR A PARTICULAR PURPOSE ON THE PRODUCT IS LIMITED IN DURATION TO THE DURATION OF THE ABOVE LIMITED WARRANTY. UNDER NO CIRCUMSTANCES SHALL LG OR ITS U.S. DISTRIBUTORS/DEALERS BE LIABLE FOR ANY INDIRECT, INCIDENTAL, CONSEQUENTIAL, SPECIAL, OR PUNITIVE DAMAGES, INCLUDING, WITHOUT LIMITATION, LOST GOODWILL, LOST REVENUES OR PROFITS, WORK STOPPAGE, IMPAIRMENT OF OTHER GOODS, COST OF REMOVAL AND REINSTALLATION OF THE PRODUCT, LOSS OF USE, OR ANY OTHER DAMAGES WHETHER BASED IN CONTRACT, TORT, OR OTHERWISE. LG’S TOTAL LIABILITY, IF ANY, SHALL NOT EXCEED THE PURCHASE PRICE PAID BY YOU FOR THE PRODUCT.

SOME STATES DO NOT ALLOW THE EXCLUSION OR LIMITATION OF INCIDENTAL OR CONSEQUENTIAL DAMAGES OR LIMITATIONS ON HOW LONG AN IMPLIED WARRANTY LASTS, SO THE ABOVE EXCLUSIONS OR LIMITATIONS MAY NOT APPLY TO YOU. THIS LIMITED WARRANTY GIVES YOU SPECIFIC LEGAL RIGHTS AND YOU MAY ALSO HAVE OTHER RIGHTS THAT VARY FROM STATE TO STATE.

THIS LIMITED WARRANTY DOES NOT COVER:

- Service trips to deliver, pick up, or install, educate how to operate, correct wiring, or correct unauthorized repairs.
- Damage or failure of the Product to perform during power failures and interrupted or inadequate electrical service.
- Damage or failure of the Product caused by leaky or broken water pipes, frozen water pipes, restricted drain lines, inadequate or interrupted water supply or inadequate supply of air.

- Damage or failure of the Product resulting from operating the Product in a corrosive atmosphere or contrary to the Product owner's manual.
- Damage or failure of the Product caused by accidents, pests and vermin, lightning, wind, fire, floods, acts of nature, or any other causes beyond the control of LG.
- Damage or failure of the Product caused by unauthorized modification or alteration, or if the Product is used for other than the intended purpose, or any water leakage where the Product was not properly installed.
- Damage or failure of the Product caused by incorrect electrical current, voltage, or plumbing codes.
- Damage or failure of the Product caused by transportation, storage, and/or handling, including scratches, dents, chips, and/or other damage to the finish of the Product, unless such damage is reported within one (1) week of delivery.
- Damage or failure of the Product resulting from misuse, abuse, improper installation, repair, or maintenance. Improper repair includes the use of parts not authorized by LG. Improper installation or maintenance includes installation or maintenance contrary to the Product owner's manual.
- Damage or failure of the Product caused by the use of parts, components, accessories, consumable cleaning products, or any other products or services that were not authorized by LG.
- Damage or missing items to any display or open box Product.
- Refurbished Product or any Product sold "As Is", "Where Is", "With all Faults", or similar disclaimer.
- Products with original serial numbers that have been removed, altered, or cannot be readily determined.
- Increases in utility costs and additional utility expenses.
- Any noises associated with normal operation.
- Products used for other than normal and proper household use (e.g., commercial or industrial use) or contrary to the Product owner's manual.
- Costs associated with removal and reinstallation of the Product for repairs, or the removal and reinstallation of the Product if it is installed in an inaccessible location or not installed in accordance with the Product Owner's manual.
- Accessories, removable components, or consumable parts (e.g. Shelves, door bins, drawers, water/air filters, racks, light bulbs, batteries, etc., as applicable), except for internal/functional parts covered under this limited warranty.

The cost of repair or replacement under these excluded circumstances shall be borne by You.

TO OBTAIN WARRANTY SERVICE AND ADDITIONAL INFORMATION

Call 1-800-243-0000 and select the appropriate option from the menu.

Or visit our website at <http://www.lg.com>

Or by mail: LG Electronics Customer Service P.O. Box 240007 Huntsville, AL 35813 ATTN: CIC

PROCEDURE FOR RESOLVING DISPUTES:

ALL DISPUTES BETWEEN YOU AND LG ARISING OUT OF OR RELATING IN ANY WAY TO THIS LIMITED WARRANTY OR THE PRODUCT SHALL BE RESOLVED EXCLUSIVELY THROUGH BINDING ARBITRATION, AND NOT IN A COURT OF GENERAL JURISDICTION. BINDING ARBITRATION MEANS THAT YOU AND LG ARE EACH WAIVING THE RIGHT TO A JURY TRIAL AND TO BRING OR PARTICIPATE IN A CLASS ACTION.

Definitions. For the purposes of this section, references to "LG" mean LG Electronics U.S.A., Inc., its parents, subsidiaries and affiliates, and each of their officers, directors, employees, agents, beneficiaries, predecessors in interest, successors, assigns and suppliers; references to "dispute" or "claim" shall include any dispute, claim or controversy of any kind whatsoever (whether based in contract, tort, statute, regulation, ordinance, fraud, misrepresentation or any other legal or equitable theory) arising out of or relating in any way to the sale, condition or performance of the product or this Limited Warranty.

Notice of Dispute. In the event you intend to commence an arbitration proceeding, you must first notify LG in writing at least 30 days in advance of initiating the arbitration by sending a letter to LG at LG Electronics, USA, Inc. Attn: Legal Department-Arbitration 111 Sylvan Avenue, Englewood Cliffs, NJ 07632. You and LG agree to engage in good faith discussions in an attempt to amicably resolve your claim. The

notice must provide your name, address, and telephone number; identify the product that is the subject of the claim; and describe the nature of the claim and the relief being sought. If you and LG are unable to resolve the dispute within 30 days, either party may proceed to file a claim for arbitration.

Agreement to Binding Arbitration and Class Action Waiver. Upon failure to resolve the dispute during the 30 day period after sending written notice to LG, you and LG agree to resolve any claims between us only by binding arbitration on an individual basis, unless you opt out as provided below. Any dispute between you and LG shall not be combined or consolidated with a dispute involving any other person's or entity's product or claim. More specifically, without limitation of the foregoing, any dispute between you and LG shall not under any circumstances proceed as part of a class or representative action. Instead of arbitration, either party may bring an individual action in small claims court, but that small claims court action may not be brought on a class or representative basis.

Arbitration Rules and Procedures. To begin arbitration of a claim, either you or LG must make a written demand for arbitration. The arbitration will be administered by the American Arbitration Association ("AAA") and will be conducted before a single arbitrator under the AAA's Consumer Arbitration Rules that are in effect at the time the arbitration is initiated (referred to as the "AAA Rules") and under the procedures set forth in this section. The AAA Rules are available online at www.adr.org/consumer. Send a copy of your written demand for arbitration, as well as a copy of this provision, to the AAA in the manner described in the AAA Rules. You must also send a copy of your written demand to LG at LG Electronics, USA, Inc. Attn: Legal Department-Arbitration 111 Sylvan Avenue, Englewood Cliffs, NJ 07632. If there is a conflict between the AAA Rules and the rules set forth in this section, the rules set forth in this section will govern. This arbitration provision is governed by the Federal Arbitration Act. Judgment may be entered on the arbitrator's award in any court of competent jurisdiction. All issues are for the arbitrator to decide, except that issues relating to the scope and enforceability of the arbitration provision and to the arbitrability of the dispute are for the court to decide. The arbitrator is bound by the terms of this provision.

Governing Law. The law of the state of your residence shall govern this Limited Warranty and any disputes between us except to the extent that such law is preempted by or inconsistent with applicable federal law.

Fees/Costs. You do not need to pay any fee to begin an arbitration. Upon receipt of your written demand for arbitration, LG will promptly pay all arbitration filing fees to the AAA unless you seek more than \$25,000 in damages, in which case the payment of these fees will be governed by the AAA Rules. Except as otherwise provided for herein, LG will pay all AAA filing, administration, and arbitrator fees for any arbitration initiated in accordance with the AAA Rules and this arbitration provision. If you prevail in the arbitration, LG will pay your attorneys' fees and expenses as long as they are reasonable, by considering factors including, but not limited to, the purchase amount and claim amount. Notwithstanding the foregoing, if applicable law allows for an award of reasonable attorneys' fees and expenses, an arbitrator can award them to the same extent that a court would. If the arbitrator finds either the substance of your claim or the relief sought in the demand is frivolous or brought for an improper purpose (as measured by the standards set forth in Federal Rule of Civil Procedure 11(b)), then the payment of all arbitration fees will be governed by the AAA Rules. In such a situation, you agree to reimburse LG for all monies previously disbursed by it that are otherwise your obligation to pay under the AAA Rules. Except as otherwise provided for, LG waives any rights it may have to seek attorneys' fees and expenses from you if LG prevails in the arbitration.

Hearings and Location. If your claim is for \$25,000 or less, you may choose to have the arbitration conducted solely on the basis of (1) documents submitted to the arbitrator, (2) through a telephonic hearing, or (3) by an in-person hearing as established by the AAA Rules. If your claim exceeds \$25,000, the right to a hearing will be determined by the AAA Rules. Any in-person arbitration hearings will be held at a location within the federal judicial district in which you reside unless we both agree to another location or we agree to a telephonic arbitration.

Opt Out. You may opt out of this dispute resolution procedure. If you opt out, neither you nor LG can require the other to participate in an arbitration proceeding. To opt out, you must send notice to LG no later than 30 calendar days from the date of the first consumer purchaser's purchase of the product by either: (i) sending an e-mail to optout@lge.com, with the subject line: "Arbitration Opt Out" or (ii) calling 1-800-980-2973. You must include in the opt out e-mail or provide by telephone: (a) your name and address; (b) the date on which the product was purchased; (c) the product model name or model number; and (d) the serial number (the serial number can be found (i) on the product; or (ii) online by accessing <https://>

www.lg.com/us/support/repair-service/schedule-repair-continued and clicking on “Find My Model & Serial Number”).

You may only opt out of the dispute resolution procedure in the manner described above (that is, by e-mail or telephone); no other form of notice will be effective to opt out of this dispute resolution procedure. Opting out of this dispute resolution procedure will not affect the coverage of the Limited Warranty in any way, and you will continue to enjoy the full benefits of the Limited Warranty. If you keep this product and do not opt out, then you accept all terms and conditions of the arbitration provision described above.



LG

Life's Good

LG Customer Information Center

For inquiries or comments,
visit **www.lg.com** or call:

1-800-243-0000 U.S.A.

1-888-542-2623 CANADA

Register your product Online!

www.lg.com