

Features

- 36" (914 mm) minimum base cabinet width
- Large/medium bowls
- 9-1/2" (241 mm) depth provides generous workspace
- Smart Divide® feature offers a lower bowl divider that increases workspace versatility
- Versatile design allows large bowl to be installed on the right or left
- No faucet holes; requires wall- or deck-mount faucet
- Matte finish offers rich, dimensional color



Material

- KOHLER Neoroc® composite is durable and built to withstand day-to-day cleaning tasks
- Solid color throughout the sink
- Heat-resistant up to 750°F
- Scratch-, stain-, chip-, and thermal-shock-resistant

Installation

- Undermount
- Easy to install in a one-person, single-day project

Recommended Products/Accessories

- K-8801 Sink drain and strainer with tailpiece
- K-8799 Sink drain and strainer basket
- K-23726 Drain treatment
- K-23730 Neoroc® cleaner

Optional Products/Accessories

- K-11352 Disposal Flange with Stopper
- K-9000 P-Trap

Included Components

- K-5198 Sink Rack
- K-5655 Sink Rack

Codes/Standards







CSA B45.5/IAPMO Z124
IAPMO Certification

KOHLER® Neoroc® Sinks Lifetime Limited Warranty

See website for detailed warranty information.

Available Colors/Finishes

Color tiles intended for reference only.

Color	Code	Description
	CM6	Matte White
	CM7	Matte Graphite
	CM1	Matte Black
	CM2	Matte Brown
	CM3	Matte Taupe
	CM4	Matte Grey

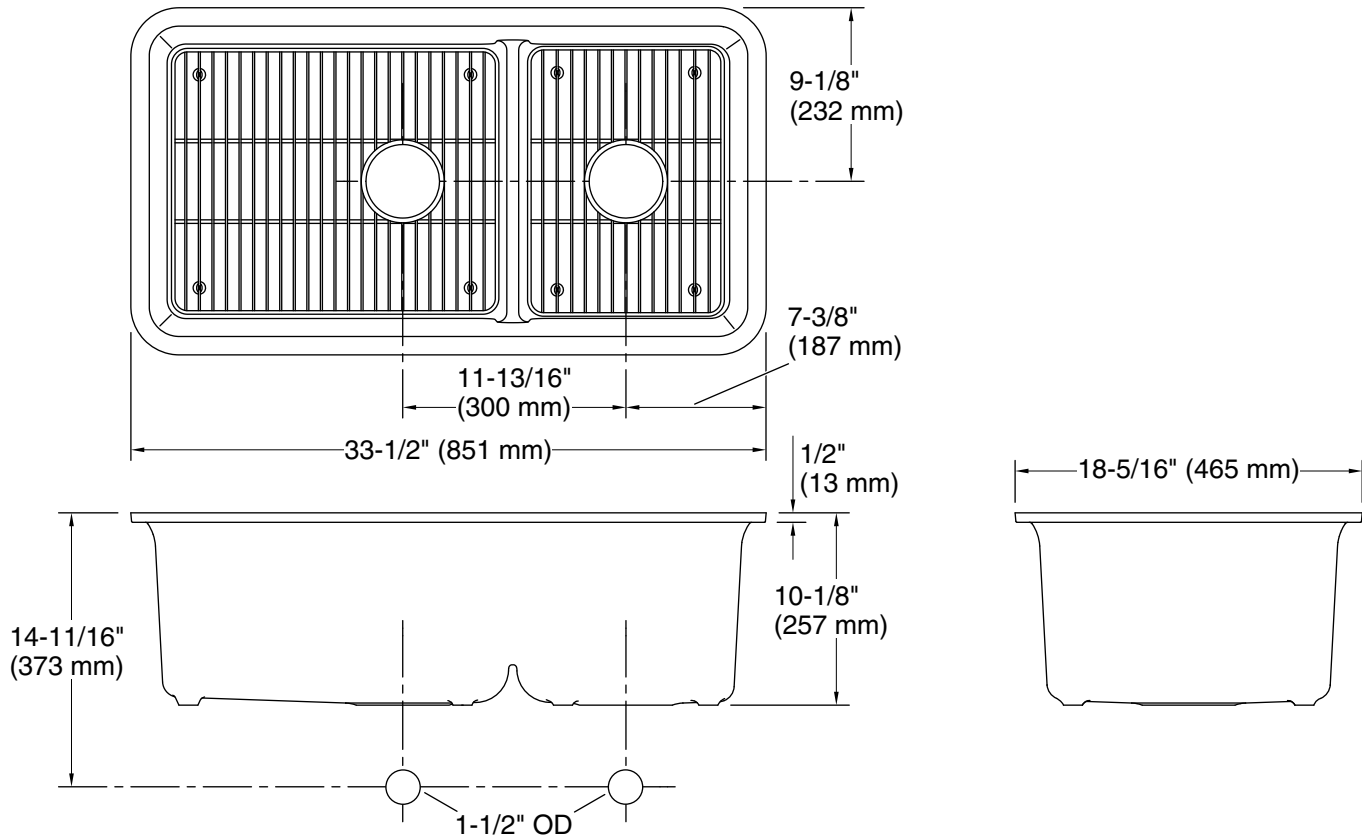

Technical Information

All product dimensions are nominal.

Bowl configuration: Off-set Large/small

Min. base cabinet width: 36" (914 mm)

Bowl area (Left): Length: 18-5/16" (465 mm)
Width: 15-3/8" (391 mm)
Bowl depth: 9-1/2" (241 mm)
Water depth: 4-1/2" (114 mm)

Bowl area (Right): Length: 11-5/8" (295 mm)
Width: 15-3/8" (391 mm)
Bowl depth: 9-1/2" (241 mm)
Water depth: 4-1/2" (114 mm)

With overflow: No

Drain hole: 3-7/8" (98 mm)

Template: Undermount, 1256394-7, required, included

Notes

Install this product according to the installation instructions.